



Borehole Electric Pumps

Electropompes Immergées

Elettropompe Sommersa



caprari
pumping power

caprari

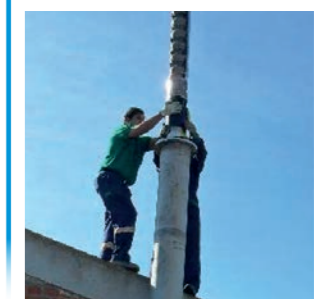
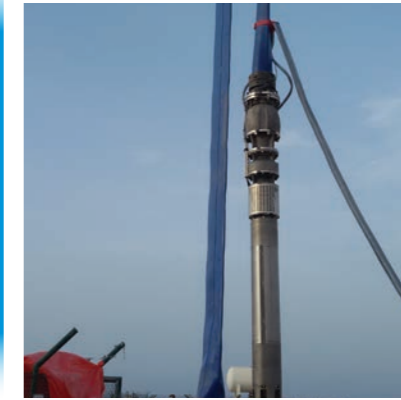

MORE
PROTECTION
EFFICIENCY
PERFORMANCE
VALUE
RESISTANCE

 **ENDURANCE**
+RESISTANCE +PERFORMANCE

caprari

Ideal for | Idéales pour | Ideali per

WATER SUPPLY

MINING

MARINE

REVERSE OSMOSIS

OFFSHORE

INFRASTRUCTURE

SPECIAL APPLICATIONS



The series of 6"÷12" borehole electric pumps in stainless steel

Is the result of the experience acquired by Caprari in over seventy-five years of endeavor to provide value innovations. Manufactured entirely with precision castings, the ENDURANCE series pumps are designed to offer excellent performance, even under the most extreme conditions with corrosive and sandy waters. Combined with the extra-thick materials, the DEFENDER® protection device, for which Caprari holds an International Patent, guarantees high levels of corrosion resistance and an extended pump service life. The market-leading efficiencies guarantee optimal energy savings and reduced environmental impact. The pumps are certified for use with drinking water and are compliant with Directive 2009/125/EC (EcoDesign - ErP).

La série d'électropompes immergées 6"÷12" en acier inoxydable

Le fruit de l'expérience de Caprari, engagée depuis plus de soixante-quinze ans dans l'innovation. Entièrement réalisées en pièces moulées de précision, les pompes de la série ENDURANCE sont conçues pour offrir d'excellentes prestations dans les conditions les plus extrêmes avec des eaux agressives et sablonneuses. Le dispositif de protection DEFENDER® – brevet international Caprari – et l'épaisseur importante des matériaux garantissent une résistance élevée à la corrosion et une longue durée de vie de la pompe. Les meilleurs rendements du marché sont une garantie d'économie d'énergie et de réduction de l'impact environnemental. Les pompes sont certifiées pour une utilisation en eau potable et sont conformes à la directive 2009/125/CE (EcoDesign - ErP).

La serie di elettropompe sommerse 6"÷12" in acciaio inox

Il frutto dell'esperienza di Caprari, da oltre settantacinque anni impegnata a fornire innovazioni di valore. Interamente realizzate con fusioni di precisione, le pompe della serie ENDURANCE sono progettate per offrire eccellenti prestazioni nelle condizioni più estreme con acque aggressive e sabbiose. Il dispositivo di protezione DEFENDER® – Caprari International Patent – e gli elevati spessori dei materiali garantiscono un'elevata resistenza alla corrosione e una lunga vita della pompa. I rendimenti al vertice del mercato sono garanzia di risparmio energetico e ridotto impatto ambientale. Le pompe sono certificate per l'impiego in acqua potabile e sono conformi alla Direttiva 2009/125/CE (EcoDesign - ErP).

Capacity up to
Débits jusqu'à
Portate fino a

120 l/s

Head up to
Haut. de refoul jusqu'à
Prevalenze fino a

850 m

Max. quantity of solids
Contenu maxi. des solides
Quantità max. solidi

150 g/m³

Salinity degree
Degré de salinité
Grado di salinità

40.000 ppm

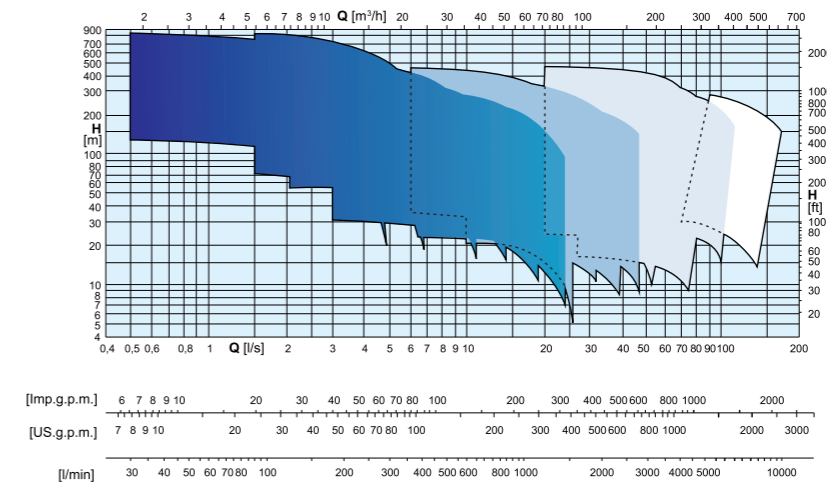

MACW: 6"÷14" submersible motors in stainless steel

Italian-made rewindable three-phase asynchronous motors. Their water filled configuration ensures optimal cooling and safe lubrication. MACW motors are available with power ratings of up to 440 kW three-phase, with flange compliant NEMA and/or Caprari standards, are certified for use with drinking water. The market-leading efficiencies guarantee optimal energy savings and reduced environmental impact. The Caprari design and patents ensure sturdiness and reliability over time. They are also available in the CPLUS configuration, with PE2+PA windings for hot water or inverter applications.

MACW : moteurs immergés 6"÷14" en acier inoxydable

Moteurs asynchrones triphasés rebobinables fabriqués en Italie. La configuration en bain d'eau assure un refroidissement parfait et une lubrification sûre. Les moteurs MACW sont disponibles dans des puissances allant jusqu'à 440 kW, avec accouplement NEMA et/ou Caprari et sont certifiés pour une utilisation en eau potable. Les meilleurs rendements du marché sont une garantie d'économie d'énergie et de réduction de l'impact environnemental. Le design et les brevets Caprari sont une garantie de robustesse et de fiabilité au fil du temps. Ils sont disponibles en configuration CPLUS, avec des bobinages PE2+ PA pour des applications en eau chaude et avec variateur de vitesse.

MACW: motori sommersi 6"÷14" in acciaio inox

Motori riavvolgibili Made in Italy asincroni trifase. La configurazione in bagno d'acqua assicura perfetto raffreddamento e sicura lubrificazione. I motori MACW sono disponibili per potenze fino 440 kW trifase, con flangiatura secondo norme NEMA e/o Caprari e sono certificati per l'impiego in acqua potabile. I rendimenti al vertice del mercato sono garanzia di risparmio energetico e ridotto impatto ambientale. Il design ed i brevetti Caprari assicurano robustezza e affidabilità nel tempo. Sono disponibili nella configurazione CPLUS, con avvolgimenti in PE2+PA per applicazioni con acqua calda o con inverter.



2 poles

Frequency
Fréquences
Frequenza

50-60 Hz

Power up to
Puissances jusqu'à
Potenze fino a

440 kW

4 poles

Frequency
Fréquences
Frequenza

50-60 Hz

Power up to
Puissances jusqu'à
Potenze fino a

295 kW

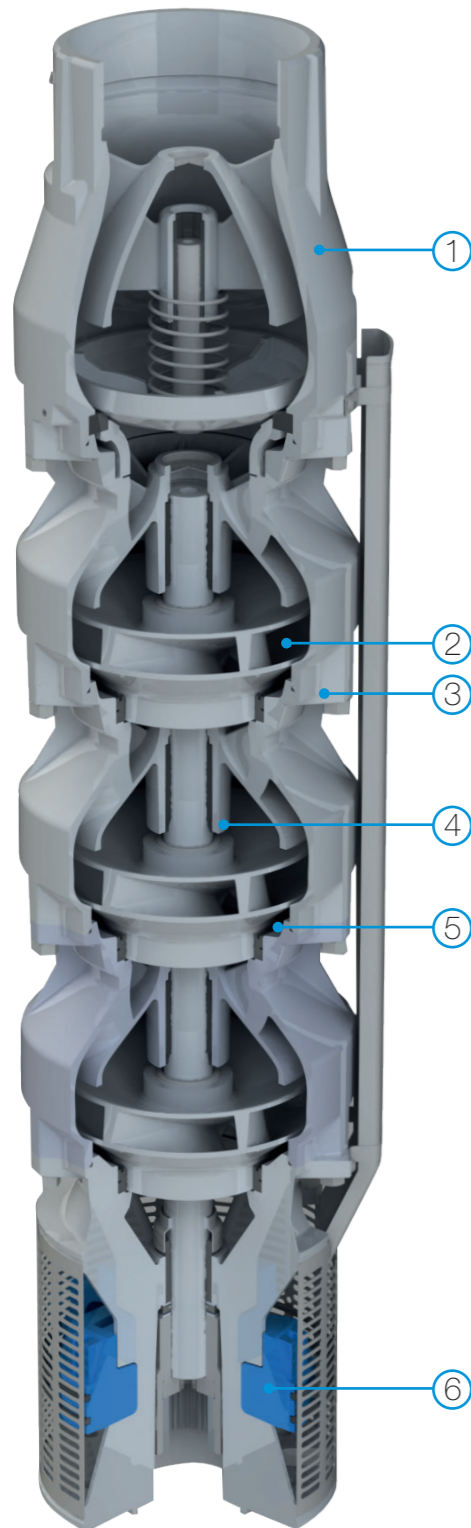

VERSATILITY OF INSTALLATION

Threaded coupling or DIN and ANSI flange options.

FLEXIBILITÉ D'INSTALLATION

Refoulement taraudé ou avec à bride DIN et ANSI.

VERSATILITÀ DI INSTALLAZIONE

Accoppiamento filettato o con flange DIN e ANSI.

HIGH PRECISION CASTED STAINLESS STEEL IMPELLERS

Strong and reliable. Guaranteed duty performances thanks to impeller trimming. Best in class efficiencies and benchmarked performances.

ROUES EN ACIER INOXAYDABLE MOULAGE DE PRÉCISION

Robustes et fiables. Les performances sont garanties sur le point de fonctionnement grâce au rognage. Rendements best in class et performances benchmark.

GIRANTI IN ACCIAIO INOX MICROFUSO

Robuste ed affidabili. Le prestazioni sono garantite sul punto di lavoro grazie alla tornitura. Rendimenti best in class e prestazioni benchmark.

ADVANCED CASTING TECHNOLOGIES AND MASSIVE CONSTRUCTION OF THE COMPONENTS

Smooth and seamless surfaces ensures continual high performance by minimizing surface resistance. High thickness ensures a long working life and wear resistance.

TECHNOLOGIE DE COULÉE DE POINTE ET CONSTRUCTION MASSIVE

Etats de surface lisses et sans discontinuité assurent des performances élevées, en éliminant les turbulences. Épaisseurs élevées, garantie de résistance à l'usure et de durée de vie.

TECNOLOGIE DI FUSIONE ALL'AVANGUARDIA E COMPONENTI CON COSTRUZIONE MASSIVA

Le superfici lisce e senza discontinuità garantiscono alte prestazioni, eliminando attriti e turbolenze all'interno del liquido. Alti spessori a garanzia di lunga durata e resistenza all'usura.

BEARING BUSHES - NEW DESIGN

With stainless steel spring core and new lip design that avoids liquid recirculation to increase the performance. Easy to disassemble for maintenance.

PALIER - NOUVELLE CONCEPTION

Avec âme à ressort en acier inoxydable et lèvres anti-recirculation qui garantissent de hautes performances en évitant la recirculation du liquide. Démontage simple pour les opérations de maintenance.

CUSCINETTI - NEW DESIGN

Con anima a molla in acciaio inox e labbro antiricircolo che garantisce maggiori prestazioni evitando il ricircolo del liquido. Semplicità di smontaggio in caso di manutenzione.

WEAR RINGS - NEW DESIGN

With stainless steel core and new lip design that avoids liquid recirculation to increase the performance.

BAGUES D'USURE - NOUVELLE CONCEPTION

Avec âme en acier inoxydable et lèvres anti-recirculation qui garantissent de hautes performances en évitant la recirculation du liquide.

ANELLI SEDE GIRANTE - NEW DESIGN

Con anima in acciaio inox e labbro antiricircolo che garantisce maggiori prestazioni evitando il ricircolo del liquido.

DEFENDER® - CAPRARI INTERNATIONAL PATENT

Ultra-resistance against the corrosion: increases component passivation, protecting the pump from the first moments after the installation.

DEFENDER® - BREVET INTERNATIONAL CAPRARI

Résistance élevée à la corrosion : ce qui permet d'accélérer la passivation des composants en acier inoxydable, en protégeant la pompe dès le premier instant après l'installation.

DEFENDER® - CAPRARI INTERNATIONAL PATENT

Ultra-resistenza alla corrosione: accelera la passivazione dei componenti in acciaio inox, proteggendo la pompa fin dai primi momenti dopo l'installazione.

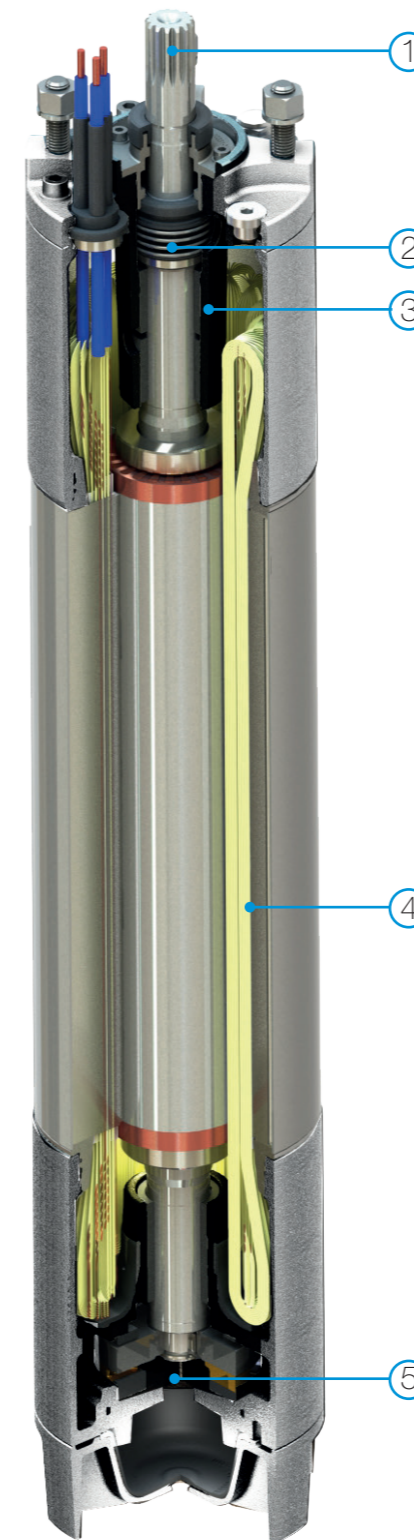

MOTOR PROTECTOR®

CAPRARI INTERNATIONAL PATENT

Pump-motor coupling protection: the area is sealed to protect the coupling and the mechanical seal of the motor from sand.

MOTOR PROTECTOR®

BREVET INTERNATIONAL CAPRARI

Dispositif pour la protection de l'accouplement pompe-moteur : la zone est fermée, protégeant ainsi l'accouplement et la garniture mécanique contre le sable.

MOTOR PROTECTOR®

CAPRARI INTERNATIONAL PATENT

Dispositivo a protezione dell'accoppiamento pompa-motore: la zona viene sigillata, proteggendo il giunto e la tenuta meccanica nel motore dalla sabbia.

STAINLESS STEEL / DUPLEX SHAFT

The best mechanical and corrosion resistance.

ARBRE EN ACIER INOXYDABLE / DUPLEX

Résistance mécanique et à la corrosion exceptionnelle.

ALBERO IN ACCIAIO INOX / DUPLEX

Massiva resistenza meccanica ed alla corrosione.

SIC/SIC MECHANICAL SEAL

Ideal for liquids with a high sand content. Exceptional resistance to high temperatures.

GARNITURE MÉCANIQUE SIC/SIC

Idéal pour l'utilisation avec des liquides à haute teneur de sable. Résistance exceptionnelle aux températures élevées.

TENUTA MECCANICA IN SIC/SIC

Ideale all'utilizzo con liquidi con alto contenuto di sabbia. Eccezionale resistenza alle alte temperature.

LINE BEARINGS

Self-lubricating composite material guarantees high resistance and precision of alignment both in working conditions and during motor handling.

PALIER

Le matériau composite autolubrifiant fournit une résistance et une précision d'alignement élevées pendant le fonctionnement et le transport.

CUSCINETTI DI LINEA

Il materiale composito autolubrificante fornisce alta resistenza e precisione di allineamento durante il funzionamento e il trasporto.

WINDINGS

in PVC (green wire) lead-free environmental-friendly. Reliable and durable.

BOBINAGE

En PVC (green wire) sans plomb respectueux de l'environnement. Fiable et résistant.

AVVOLGIMENTI

In PVC (green wire) senza piombo eco compatibili. Affidabili e duraturi.

HT THRUST BEARING®

CAPRARI INTERNATIONAL PATENT

- extreme reliability and strong resistance to the axial thrust up to 70.000N.
- wide safety-margin against axial thrust generated by wet-ends.

PALIER DE BUTÉE HT®

BREVET INTERNATIONAL CAPRARI

- fiabilité exceptionnelle et résistance à la poussée axiale jusqu'à 70 000N.
- grande marge de sécurité contre la charge axiale générée par le flux hydraulique.

CUSCINETTO REGGISPINTA HT®







CAPRARI INTERNATIONAL PATENT

- estrema affidabilità e resistenza alla spinta assiale fino a 70.000N.
- ampio margine di sicurezza contro il carico assiale generato dalle idrauliche.

caprari

pumping power

CAPRARI IN THE WORLD

-  CAPRARI SPA
-  BOMBAS CAPRARI S.A.
-  CAPRARI FRANCE SAS
-  CAPRARI PORTUGAL LDA
-  CAPRARI TUNISIE S.A.
-  CAPRARI PUMPS (UK) LTD
-  CAPRARI PUMPEN GMBH
-  CAPRARI HELLAS S.A.
-  CAPRARI PUMPS SHANGHAI CO. LTD.
-  CAPRARI PUMPS AUSTRALIA PTY LTD



ISO 9001
ISO 14001
ISO 45001
BUREAU VERITAS
Certification



www.caprari.com

Pump Control Technology

Boosting and Distribution of surface water

Wastewater Transport and Treatment

Water Collection and Distribution