

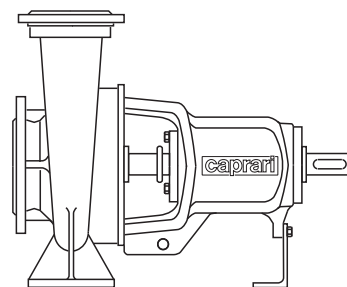

NORM SINGLE-STAGE
PUMPS -EN733 (DIN 24255)
*POMPES MONOCELLULAIRES
NORMALISEES - EN733 (DIN 24255)*
**POMPE MONOGIRANTI
NORMALIZZATE - EN733 (DIN 24255)**

NC



caprari

pumping power

	Page - Page - Pagina
• Technical data <i>Données techniques</i> Dati tecnici	3
• Pump coding <i>Identification du sigle</i> Esemplificazione sigla	4
• Performance ranges <i>Champs de performances</i> Campi di prestazioni	5
• Performance ranges - Operating limits <i>Champs de performances - Limites de fonctionnement</i> Campi di prestazioni - Limiti di funzionamento	6
• Pump construction and materials <i>Construction de la pompe et matériels</i> Costruzione pompa e materiali	7
• Technical data standardized enclosed electric motors <i>Données techniques moteurs électriques fermés</i> Dati tecnici motore elettrico chiuso normalizzato	8
• Performances curves at 950 n [min-1] <i>Caractéristiques de fonctionnement à 950 n [min-1]</i> Caratteristiche di funzionamento a 950 n [min-1]	9
• Performances curves at 1450 n [min-1] <i>Caractéristiques de fonctionnement à 1450 n [min-1]</i> Caratteristiche di funzionamento a 1450 n [min-1]	14
• Performances curves at 2900 n [min-1] <i>Caractéristiques de fonctionnement à 2900 n [min-1]</i> Caratteristiche di funzionamento a 2900 n [min-1]	62
• Overall dimensions and weights <i>Dimensions d'encombrement et poids</i> Dimensioni di ingombro e pesi	89
• Selection - Dimensions and weights for base mounted electric pumps 2P / 50Hz <i>Sélection - Dimensions et poids des électropompes sur socle 2P / 50Hz</i> Selezione - Dimensioni e pesi elettropompe su base 2P / 50Hz	91
• Selection - Dimensions and weights for base mounted electric pumps 4P / 50Hz <i>Sélection - Dimensions et poids des électropompes sur socle 4P / 50Hz</i> Selezione - Dimensioni e pesi elettropompe su base 4P / 50Hz	95
• Selection - Dimensions and weights for base mounted electric pumps 6P / 50Hz <i>Sélection - Dimensions et poids des électropompes sur socle 6P / 50Hz</i> Selezione - Dimensioni e pesi elettropompe su base 6P / 50Hz	101
Flanges (UNI EN 1092-2) - Brides (UNI EN 1092-2) - Flange (UNI EN 1092-2)	103

GENERAL INFORMATION

Single-stage horizontal shaft pumps with main dimensions and characteristics conforming to EN733 (DIN 24255) standards.

- Pump casing: volute type with flanged delivery port.
- Impeller: high efficiency closed type with balanced axial thrust.
Available in either cast iron or AISI 316 stainless steel.
- Shaft and supports:
the AISI 420 stainless steel shaft (fully protected against contact with the pumped water) is guided and supported by two ball bearings housed in the connecting support that are permanently lubricated with high quality grease to guarantee longer life.
The wide safety margin considered when sizing the support, the shaft and the bearings allows the pump to be coaxially coupled to both electric motors and internal combustion engines.
- Seal:
the mechanical type, housed in the connecting support and easily replaceable.
- Coupling to the motor
the NC series pumps can be coupled to IP 55 standard electric motors with B3 motor mounting. The pumps can be coupled to high-efficiency motors. The BACK PULL OUT constructional concept, connection to the motor with a flexible coupling and spacer, available on request, allow the wet end to be disassembled from the rear for inspection purposes and repairs without disconnecting the motor or the pump casing from the piping.
- Direction of rotation:
clockwise viewed from drive side.
- Port positioning: axial for suction / radial delivery port pointing upwards.

APPLICATIONS

The NC series standardized pumps have been designed for several applications, such as fire-fighting, industrial water supply, industrial uses, anti-frost protection, irrigation, medium and large heating and air conditioning systems and water supply for both civil and industrial uses.

LIMITS

- Max. temperature of pumped liquid: +90°C.
- Min. temperature of pumped liquid: -10°C.
- Max operating time with closed discharge and liquid at 90°C: 30 sec.
- Nominal pressure 10/16 bar (with flanging conforming to UNI 2223 PN16/PN25).
- Maximum content of solids, the same hardness and granulometry of silt: 50 [g/m³]
- The pumps can operate with all fluids chemically and mechanically compatible with the pump materials.

Special versions can be supplied on request.

NOTE:

Upon request the curves NPSH are available until 16 m for 2-pole electric pumps.

CARACTÉRISTIQUES

Pompes monocellulaires à axe horizontal avec caractéristiques et dimensions principales normalisées EN733 (DIN 24255).

- Corps de pompe : type à volute avec orifice de refoulement à bride.
- Roue : de type fermé à haut rendement, avec équilibrage et la poussée axiale.
Disponible en fonte ou en acier inoxydable AISI 316
- Arbre et paliers:
l'arbre en acier inoxydable AISI 420, (totalement protégé du contact avec l'eau pompée) est guidé et soutenu par deux roulements à billes logés dans le palier de liaison à lubrification permanente par de la graisse haute qualité, en garantie d'une très longue durée.
L'ample marge de sécurité adoptée dans le dimensionnement du palier, de l'arbre et des roulements, permet l'accouplement coaxial tant à des moteurs électriques qu'à combustion interne.
- Garniture:
de type mécanique logée dans le palier de liaison et facile à remplacer.
- Accouplement au moteur
les pompes série NC peuvent être accouplées à des moteurs électriques suivant le standard IP 55 dans la forme de construction B3; la pompe peut être accouplée à des moteurs à haut rendement. Le principe de fabrication «BACK PULL OUT» ainsi que l'accouplement au moteur par joint élastique et entretoise d'espacement sur demande permettent de démonter la partie hydraulique par l'arrière pour les contrôles techniques ou la réparation, sans débrancher le moteur et le corps de la pompe des tuyauteries.
- Sens de rotation :
horaire vu côté commande.
- Orientation des orifices : aspiration axiale / orifice de refoulement radiale tourné vers le haut.

APPLICATIONS

Les pompes normalisées série NC ont été conçues pour de nombreux secteurs d'activité : anti-incendie, réseaux industriels de distribution d'eau, anti-gel, irrigation, installations moyennes et grandes de chauffage et de conditionnement, alimentation en eau potable à usage civil et industriel.

LIMITES D'EMPLOI

- Température max. du liquide pompé : +90°C
- Température min. du liquide pompé : -10°C
- Temps max. de fonctionnement à refoulement fermé avec liquide à 90°C: 30 s.
- Pression nominale 10/16 bar (avec brides normalisées UNI 2223 PN16/PN25).
- Contenu maximum des substances solides de la dureté et la granulométrie du limon: 50 [g/m³].
- Possibilité de véhiculer de nombreux liquides chimiquement et mécaniquement agressifs, compatibles avec les matériaux constitutifs des pompes.

Des versions spéciales peuvent être fournies sur demande.

NOTE:

Sur demande sont disponibles les courbes avec NPSH jusqu'à 16m pour les électropompes à 2 pôles.

CARATTERISTICHE

Pompe monogiranti ad asse orizzontale con caratteristiche e dimensioni principali secondo le norme EN733 (DIN 24255).

- Corpo pompa: del tipo a voluta con bocca premente flangiata.
- Girante: del tipo chiuso ad elevato rendimento, con equilibratura della spinta assiale.
Disponibile in ghisa o acciaio inox AISI 316.
- Albero e supporti:
l'albero in acciaio inossidabile AISI 420, (totalmente protetto dal contatto con l'acqua pompata) è guidato e sostenuto da due cuscinetti a sfere alloggiati nel supporto di collegamento e lubrificati a grasso permanente di alta qualità a garanzia di una più lunga durata.
L'ampio margine di sicurezza tenuto nel dimensionare il supporto, l'albero ed i cuscinetti, consente l'accoppiamento coassiale sia a motori elettrici che endotermici.
- Tenuta:
di tipo meccanico alloggiata nel supporto di collegamento e facilmente sostituibile.
- Accoppiamento al motore
le pompe serie NC, possono essere accoppiate a motori elettrici standard IP 55 in forma costruttiva B3; le pompe possono essere accoppiate a motori ad alto rendimento.
Il concetto costruttivo BACK PULL OUT e l'accoppiamento al motore con giunto elastico e distanziale spaziatore su richiesta consentono lo smontaggio posteriore della parte idraulica per l'ispezione o la riparazione, senza sconnettere il motore ed il corpo pompa dalle tubazioni.
- Senso di rotazione:
orario visto dal lato comando.
- Orientamento bocche: aspirante assiale / premente radiale rivolta verso l'alto.

APPLICAZIONI

Le pompe normalizzate serie NC sono state studiate per i settori di utilizzo quali antincendio, acquedottistica, industriale, antibrina, irrigazione, impianti di riscaldamento e condizionamento di medie e grandi dimensioni e approvvigionamento idrico sia ad uso civile che industriale.

LIMITI D'IMPIEGO

- Temperatura max. liquido sollevato: +90°C.
- Temperatura min. liquido sollevato: -10°C.
- Tempo max di funzionamento a bocca chiusa con liquido a 90°C.: 30 sec.
- Pressione nominale 10/16 bar (con flangiature secondo UNI 2223 PN16/PN25).
- Contenuto massimo di sostanze solide della durezza e granulometria del limo: 50 [g/m³].
- Possibilità di veicolamento di tutti quei liquidi chimicamente e meccanicamente compatibili con i materiali costruttivi delle pompe.

Su richiesta possono essere fornite esecuzioni speciali.

NOTA:

Su richiesta sono disponibili curve con NPSH a 16m per le elettropompe a 2 poli.

PUMP CODING
IDENTIFICATION DU SIGLE
ESEMPLIFICAZIONE SIGLA

Code - Désignation - Sigla
NC50-315/. - NCF50-315/. - NCH50-315/. - NCHF50-315/.

Series NC (with Cast Iron impeller) -
Séries NC (Avec roue en fonte grise)
Serie NC (con girante in ghisa)

NC

Series NCF (with AISI 316 stainless steel impeller) -
Séries NCF (Avec roue en acier inox AISI 316)
Serie NCF (con girante in acciaio inox AISI 316)

NCF

50

-

315

/.

Series NCH (High pressure) -
Séries NCH (Haute pression) - Serie NCH (Alta pressione)

NCH

Series NCHF (High pressure) (with AISI 316 stainless steel impeller) -
Séries NCHF (Haute pression) (Avec roue en acier inox AISI 316) -
Serie NCHF (Alta pressione) (con girante in acciaio inox AISI 316)

NCHF

Nominal diameter (mm) of delivery port -
Diamètre nominal (mm) orifice de refoulement - Diametro nominale (mm) bocca premente

Impeller diameter (mm) - Diamètre roue (mm) - Diametro girante (mm)

Executions on demand - Executions sur demande - Esecuzioni a richiesta

MECHANICAL SEAL

ÉTANCHÉITÉ MÉCANIQUE

TENUTA MECCANICA

Component / Particulier / Particolare				
Type Type Tipo	Ressort Spring Molla	Joints Gaskets Guarnizioni	Static seat Grain fixe Anello fisso	Rotatic seat Grain tournant Anello rotante
Material/ Matériel / Materiale				
Standard	AISI 316	EPDM	SILICON CARBIDE CARBURE DE SILICIUM CARBURO DI SILICIO	SILICON CARBIDE CARBURE DE SILICIUM CARBURO DI SILICIO

PUMPED LIQUID

Conforming to : DIN 24960 - ISO 3069.

TOLERANCES

Service conditions have been measured with cold water (15°C - 59°F) at 1 bar atmospheric pressure. These tolerances are guaranteed with standard assembly line pumps built according to UNI/ISO 9906 Grade 3B.

Catalogue data are for liquids with a density of 1 kg/dm³, and kinematic viscosity not exceeding 1 mm²/s. If requested the pump can be tested according to UNI/ISO 9906 Grade 2B standards.

LIQUIDE À POMPER

Normalisé : DIN 24960 - ISO 3069.

TOLERANCES

Les caractéristiques de fonctionnement ont été mesurées avec de l'eau froide (15°C.) à la pression atmosphérique (1bar). Comme il s'agit de pompes construites en séries, elles sont garanties selon les normes UNI/ISO 9906 Niveau 3B.

Les données du catalogue se réfèrent à des liquides ayant une densité de 1 kg/dm³ et une viscosité cinématique qui ne dépasse pas 1 mm²/s. Sur demande, peuvent être testées selon normes UNI/ISO 9906 Niveau 2B.

LIQUIDO DA SOLLEVARE

Secondo le norme : DIN 24960 - ISO 3069.

TOLLERANZE

Le caratteristiche di funzionamento sono state rilevate con acqua fredda (15°C) alla pressione atmosferica (1bar) e vengono garantite, trattandosi di pompe costruite in serie, secondo le norme UNI/ISO 9906 grado 3B.

I dati di catalogo si riferiscono a liquidi con densità di 1kg/dm³ e con viscosità cinematica non superiore a 1mm²/s. Su richiesta, possono essere collaudate secondo le norme UNI/ISO 9906 grado 2B.

Performance ranges
Champs de performance
Campi di prestazione

Performance curves at 2900 n [min⁻¹] / *Caractéristiques de fonctionnement à 2900 n [min⁻¹]* / *Caratteristiche di funzionamento a 2900 n [min⁻¹]*

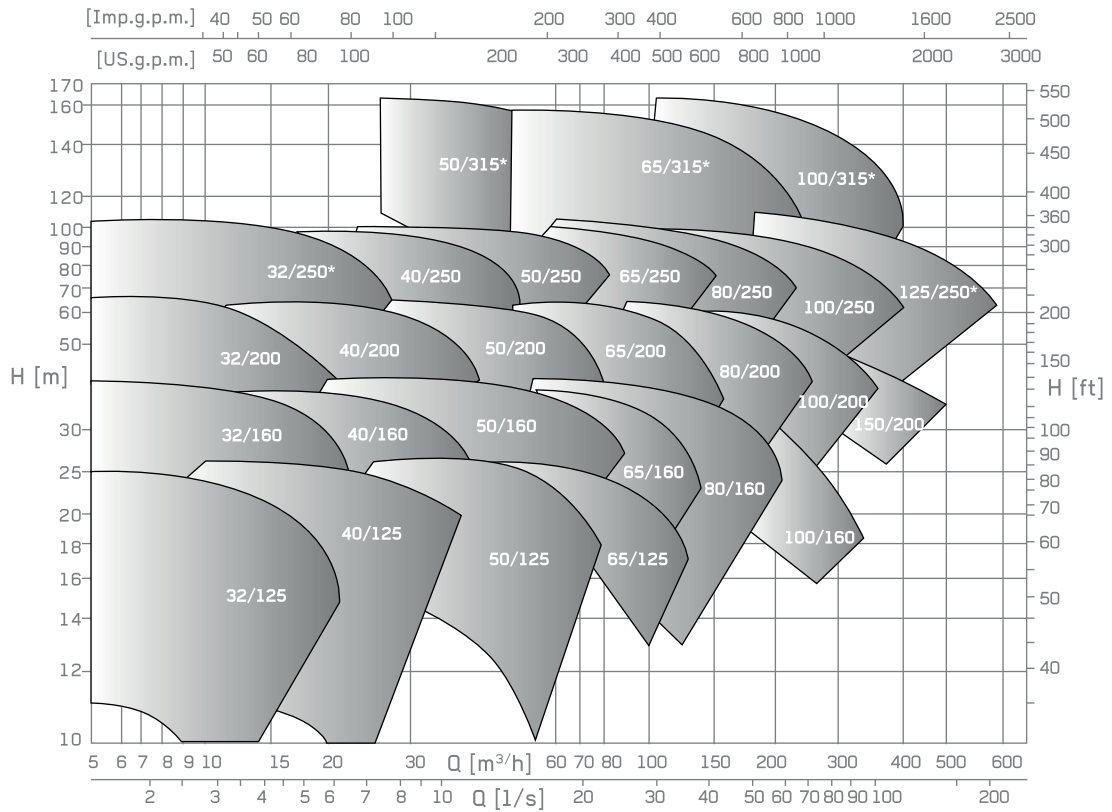

Performance curves at 1450 n [min⁻¹] / *Caractéristiques de fonctionnement à 1450 n [min⁻¹]* / *Caratteristiche di funzionamento a 1450 n [min⁻¹]*

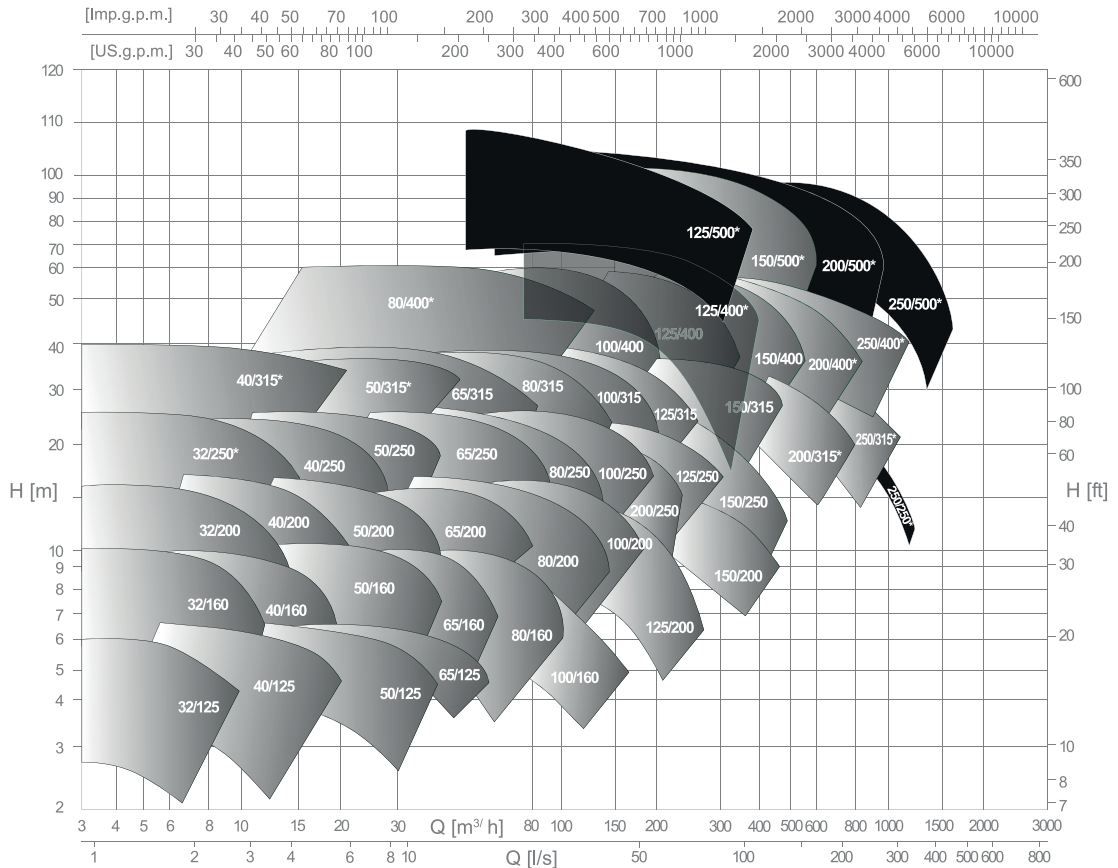

*Parameters not covered by EN733 (DIN24255): see performance fields / *Tailles non prévues en EN733 (DIN24255): Voir plages de performance / Grandezze non previste in EN733 (DIN24255): vedi campi di prestazione*

Performance ranges - Operating limits
 Champs de performance - Limites de fonctionnement
 Campi di prestazione - Limiti di funzionamento

Performance curves at 950 n [min⁻¹] / Caractéristiques de fonctionnement à 950 n [min⁻¹] / Caratteristiche di funzionamento a 950 n [min⁻¹]

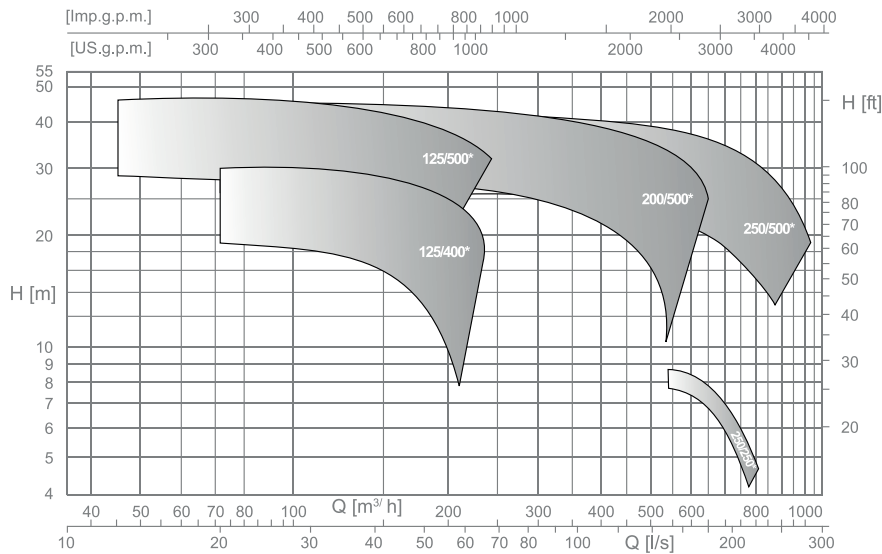

* Parameters not covered by EN733 (DIN24255): see performance fields / *Tailles non prévues en EN733 (DIN24255): Voir plages de performance* / Grandezze non previste in EN733 (DIN24255): vedi campi di prestazione

OPERATING LIMITS / LIMITES DE FONCTIONNEMENT / LIMITI DI FUNZIONAMENTO

Maximum speed Vitesse maximum Velocità massima	[min ⁻¹]
NC32-125	3500
NCF32-125	
NC32-160	3500
NCF32-160	
NC32-200	3500
NCF32-200	
NC32-250	3500
NCF32-250	
NC40-125	3500
NCF40-125	
NC40-160	3500
NCF40-160	
NC40-200	3500
NCF40-200	
NC40-250	3500
NCF40-250	
NC40-315	1750
NCF40-315	
NC50-125	3500
NCF50-125	
NC50-160	3500
NCF50-160	
NC50-200	3500
NCF50-200	
NC50-250	3500
NCF50-250	
NC50-315	1750
NCF50-315	
NC65-125	3500
NCF65-125	
NC65-160	3500
NCF65-160	
NC65-200	3500
NCF65-200	

Maximum speed Vitesse maximum Velocità massima	[min ⁻¹]
NC65-250	3500
NCF65-250	
NC65-315	1750
NCF65-315	
NC80-160	3500
NCF80-160	
NC80-200	3500
NCF80-200	
NC80-250	3500
NCF80-250	
NC80-315	2200
NCF80-315	
NC80-400	1750
NCF80-400	
NC100-160	3500
NCF100-160	
NC100-200	3500
NCF100-200	
NC100-250	3500
NCF100-250	
NC100-315	2200
NCF100-315	
NC100-400	1750
NCF100-400	
NC125-200	3500
NCF125-200	
NC125-250	2200
NCF125-250	
NC125-315	1750
NCF125-315	
NC125-400	1750
NCF125-400	
NC150-200	1750
NCF150-200	

Maximum speed Vitesse maximum Velocità massima	[min ⁻¹]
NC150-250	1750
NCF150-250	
NC150-315	1750
NCF150-315	
NC150-400	1750
NCF150-400	
NC200-250	1750
NCF200-250	
NC200-315	1750
NCF200-315	
NC200-400	1750
NCF200-400	
NC250-315	1750
NCF250-315	
NC250-400	1750
NCF250-400	
NCH50-315	2900
NCHF50-315	
NCH65-315	2900
NCHF65-315	
NCH100-315	2900
NCHF100-315	
NCH125-250	2900
NCHF125-250	
NCH125-400	1750
NCHF125-400	
NCH125-500	1450
NCHF125-500	
NCH150-500	1450
NCHF150-500	
NCH200-500	1450
NCHF200-500	
NCH250-250	1750
NCHF250-250	
NCH250-500	1750
NCHF250-500	

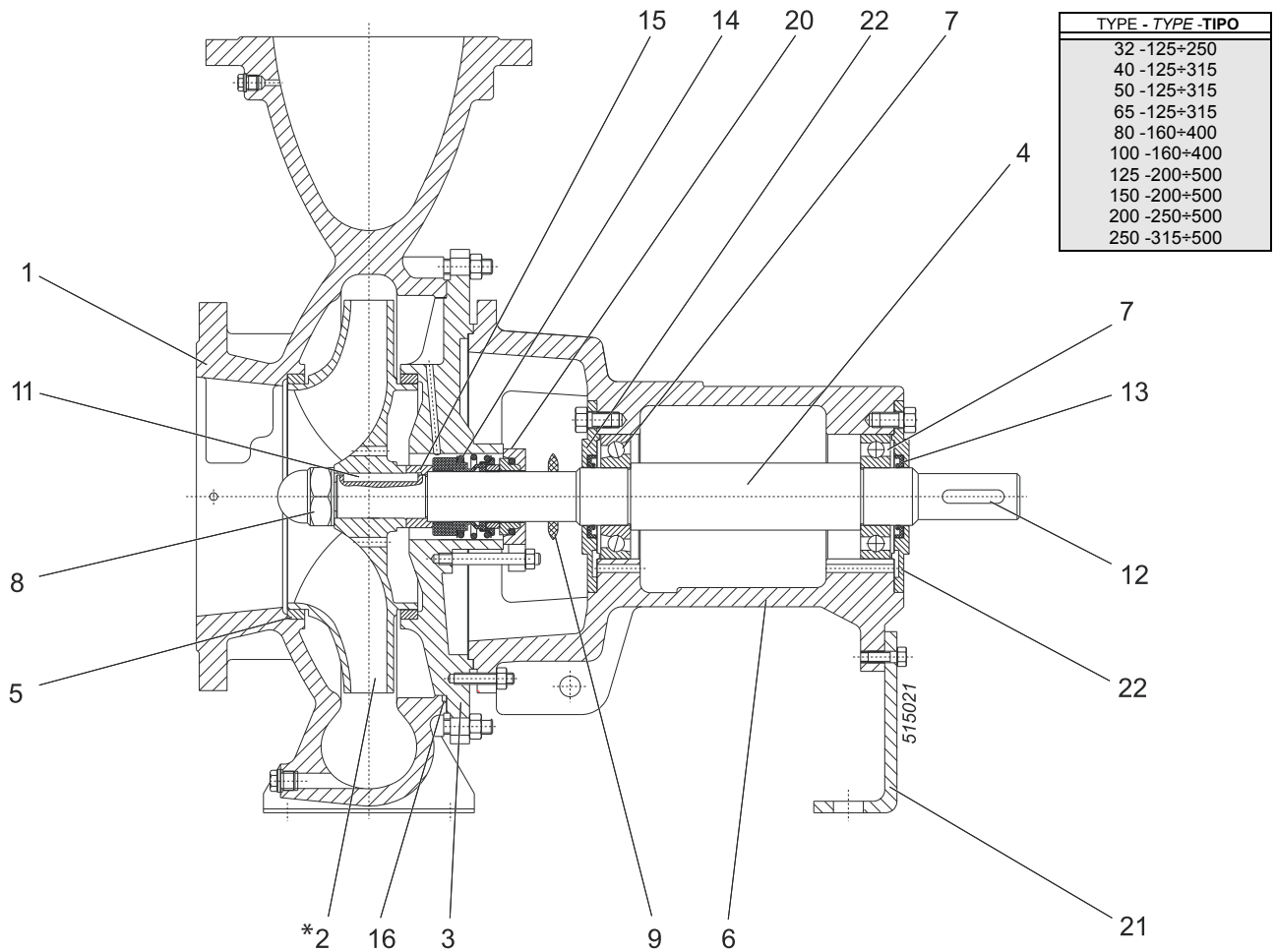

Pos.	Parts	Materials	Nomenclature	Matériaux	Nomenclatura	Materiale
1	Pump casing	Cast iron	Corps de pompe	Fonte grise	Corpo pompa	Ghisa grigia
2*	Impeller	Cast iron	Roue	Fonte grise	Girante	Ghisa grigia
2*	Impeller	Stainless steel	Roue	Acier inox	Girante	Acciaio inox
3	Connection support	Cast iron	Palier de liaison	Fonte grise	Supporto di collegamento	Ghisa grigia
4	Shaft	Stainless steel	Arbre	Acier inox	Albero	Acciaio inox
5	Wear ring	Cast iron	Bague d'usure	Fonte grise	Anello sede girante	Ghisa grigia
6	Support	Cast iron	Support	Fonte grise	Supporto	Ghisa grigia
7	Bearing	-	Palier	-	Cuscinetto	-
8	Nut	Stainless steel	Ecrou	Acier inox	Dado	Acciaio inox
9	Water retainer ring	Nitrile rubber	Bague déflecteur	Caoutchouc nitrile	Anello para-acqua	Gomma nitrilica
11	Feather key	Stainless steel	Languette	Acier inox	Linguetta	Acciaio inox
12	Feather key 2	Steel	Languette 2	Acier	Linguetta 2	Acciaio
13	Seal ring	Nitrile rubber	Anneau d'étanchéité	Caoutchouc nitrile	Anello di tenuta	Gomma nitrilica
14	Mechanical seal	Silicon carbide/silicon carbide	Garniture mécanique	Carbure de silicium/ carbure de silicium	Tenuta meccanica	Carburo di silicio/ carburo di silicio
15	Shaft spacer sleeve	Stainless steel	Entretoise d'arbre	Acier inox	Bussola albero	Acciaio inox
16	OR seal	Nitrile rubber	Anneau torique	Caoutchouc nitrile	Anello di tenuta OR	Gomma nitrilica
20	Cover mechanical seal	Cast iron	Couvercle garniture mécanique	Fonte grise	Coperchio tenuta meccanica	Ghisa grigia
21	Duck foot pedestal	Steel	Pied de soutien	Acier	Piede di sostegno	Acciaio
22	Cover bearing	Cast iron	Couvercle palier	Fonte grise	Coperchio cuscinetto	Ghisa grigia

Screws and nuts in stainless steel.

* In AISI 316 for the NCF./... versions

Vis et écrous en acier inox.

* En acier inox AISI 316 pour les versions NCF./...

Viti e dadi in acciaio inox

* In acciaio inox AISI 316 per versioni NCF./...

Technical data standardized enclosed electric motors (Indicatives values according to the type of motor installed)
 Données techniques moteurs électriques fermés normalisés (Valeurs indicatives en fonction de la marque du moteur utilisé)
 Dati tecnici motore elettrico chiuso normalizzato (Valori indicativi in funzione della marca di motore utilizzato)

Motor power Puiss. moteur Potenza motore	2 Poles 50 Hz 2 Pôles 50 Hz 2 Poli 50 Hz			4 Poles 50 Hz 4 Pôles 50 Hz 4 Poli 50 Hz			6 Poles 50 Hz 6 Pôles 50 Hz 6 Poli 50 Hz		
	Max. number starts/hour* Nombre maxi. de démarrages/heure* Numero massimo di avviamenti/ora*	Voltage variation Variation de tension Variazione di tensione	Dinamic momentum J Momentum dynamique J Momento dinamico J	Max. number starts/hour* Nombre maxi. de démarrages/heure* Numero massimo di avviamenti/ora*	Voltage variation Variation de tension Variazione di tensione	Dinamic momentum J Momentum dynamique J Momento dinamico J	Max. number starts/hour* Nombre maxi. de démarrages/heure* Numero massimo di avviamenti/ora*	Voltage variation Variation de tension Variazione di tensione	Dinamic momentum J Momentum dynamique J Momento dinamico J
	[kW]	[%]	[kg m ²]	[kW]	[%]	[kg m ²]	[kW]	[%]	[kg m ²]
0,75	3	± 10 (400V)	0,001	3	± 10 (400V)	0,003	-	-	-
1,1	3	± 10 (400V)	0,002	3	± 10 (400V)	0,004	-	-	-
1,5	3	± 10 (400V)	0,002	3	± 10 (400V)	0,005	-	-	-
2,2	3	± 10 (400V)	0,003	3	± 10 (400V)	0,01	-	-	-
3	3	± 10 (400V)	0,005	3	± 10 (400V)	0,013	-	-	-
4	3	± 10 (400V)	0,008	3	± 10 (400V)	0,02	3	± 10 (400V)	0,05
5,5	3	± 10 (400V)	0,014	3	± 10 (400V)	0,035	3	± 10 (400V)	0,065
7,5	3	± 10 (400V)	0,017	3	± 10 (400V)	0,047	3	± 10 (400V)	0,117
11	3	± 10 (400V)	0,051	3	± 10 (400V)	0,107	3	± 10 (400V)	0,177
15	3	± 10 (400V)	0,064	3	± 10 (400V)	0,129	3	± 10 (400V)	0,316
18,5	3	± 10 (400V)	0,076	3	± 10 (400V)	0,19	3	± 10 (400V)	0,468
22	3	± 10 (400V)	0,117	3	± 10 (400V)	0,226	3	± 10 (400V)	0,548
30	3	± 10 (400V)	0,174	3	± 10 (400V)	0,361	3	± 10 (400V)	0,884
37	3	± 10 (400V)	0,205	3	± 10 (400V)	0,63	3	± 10 (400V)	1,197
45	3	± 10 (400V)	0,302	3	± 10 (400V)	0,738	3	± 10 (400V)	2,338
55	3	± 10 (400V)	0,408	3	± 10 (400V)	1,024	3	± 10 (400V)	2,797
75	3	± 10 (400V)	0,799	3	± 10 (400V)	2,083	3	± 10 (400V)	4,741
90	3	± 10 (400V)	1,071	3	± 10 (400V)	2,546	3	± 10 (400V)	5,823
110	3	± 10 (400V)	2,031	3	± 10 (400V)	3,49	3	± 10 (400V)	6,654
132	3	± 10 (400V)	2,207	3	± 10 (400V)	4,014	3	± 10 (400V)	7,985
160	3	± 10 (400V)	2,487	3	± 10 (400V)	5,236	3	± 10 (400V)	10,386
200	3	± 10 (400V)	2,907	3	± 10 (400V)	5,701	3	± 10 (400V)	12,413
250	3	± 10 (400V)	3,812	3	± 10 (400V)	9,297	3	± 10 (400V)	13,933
280	3	± 10 (400V)	3,812	3	± 10 (400V)	9,297	-	-	-
315	3	± 10 (400V)	4,463	3	± 10 (400V)	10,286	-	-	-
355	3	± 10 (400V)	4,463	3	± 10 (400V)	11,275	-	-	-
375	3	± 10 (400V)	5,58	3	± 10 (400V)	11,9	-	± 10 (400V)	-

Axial drive only, by flexible coupling.

Electric motor operating limits in compliance with IEC 34-1

* Equally distributed.

"" = Contact the sales network

Entraînement seulement coaxial par accouplement élastique.

Limites de fonctionnement pour le moteur électriques suivant les IEC 34-1

* Conseillés uniformément repartis.

"" = Contacter le réseau de vente

Azionamento solo coassiale tramite giunto elastico.

Limiti d'utilizzo motore elettrico secondo IEC 34-1.

* Consigliati equamente ripartiti.

"" = Contattare la rete di vendita

SPECIFICATIONS
Efficiency class: IE3

CARACTÉRISTIQUE]
Classe de rendement: IE3

CARATTERISTICHE]
Classe di efficienza: IE3

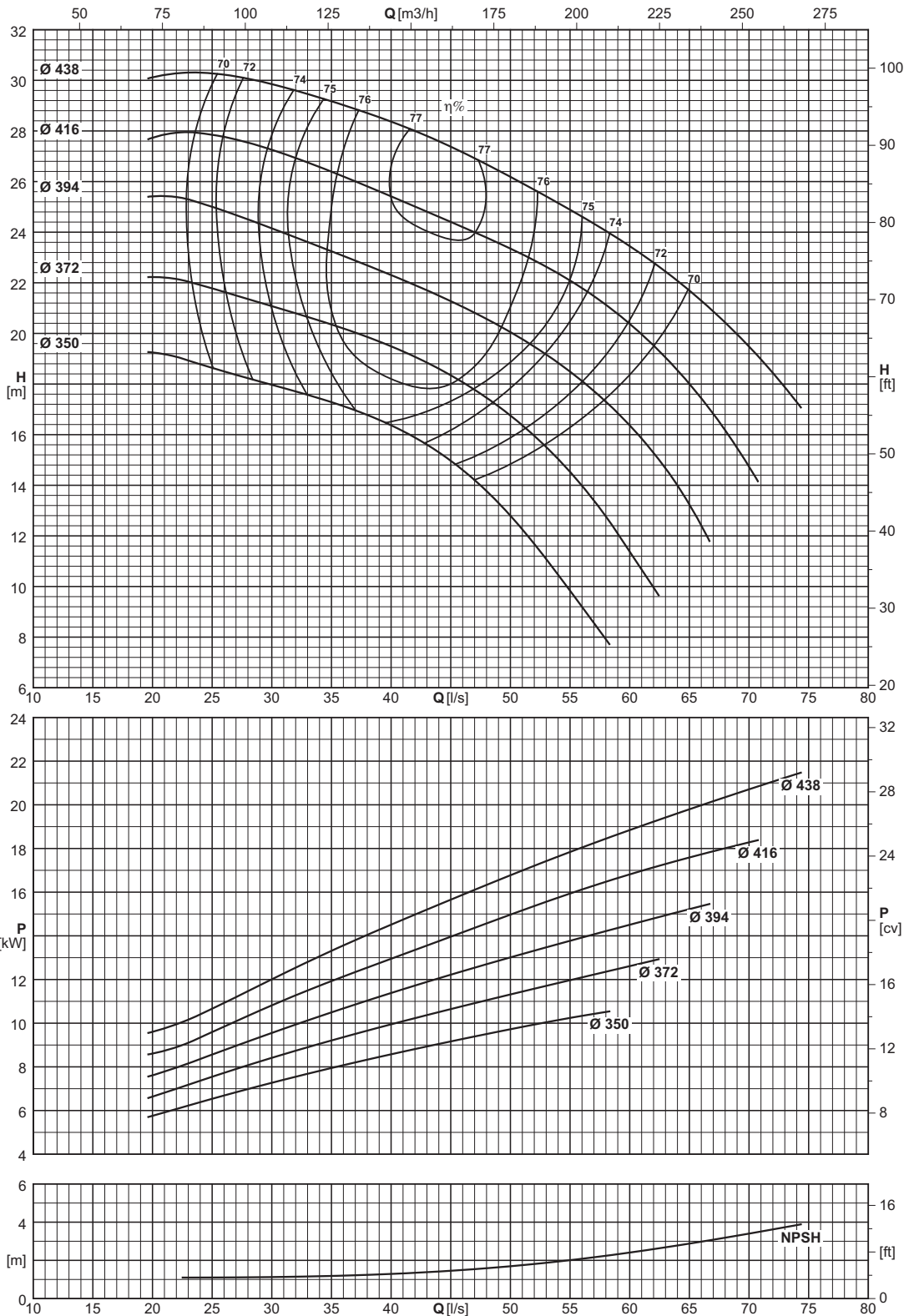

Type Type Tipo	Inlet maximum pressure (*) Pression maximale en aspiration (*) Pressione massima in aspirazione (*)	Dynamic momentum J Momentum dynamique J Momento dinamico J	
		With cast iron impellers Avec roues en fonte Con giranti in ghisa	With AISI 316 impellers Avec roues en AISI 316 Con giranti in AISI 316
		J=1/4PD ²	
	[bar]	[kgm ²]	[kgm ²]
NCH125-400	6	-	(F) -

(*) Value referred to the impeller with maximum diameter. (*) Valeur se référant à la roue à ailettes avec le diamètre maximum. (*) Valore riferito alla girante con diametro massimo

NCH 125-500

950 n [min⁻¹]

caprari

Operating data
Caracteristiques de fonctionnement
Caratteristiche di funzionamento

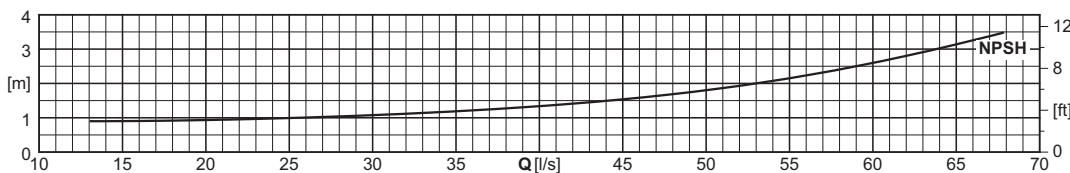
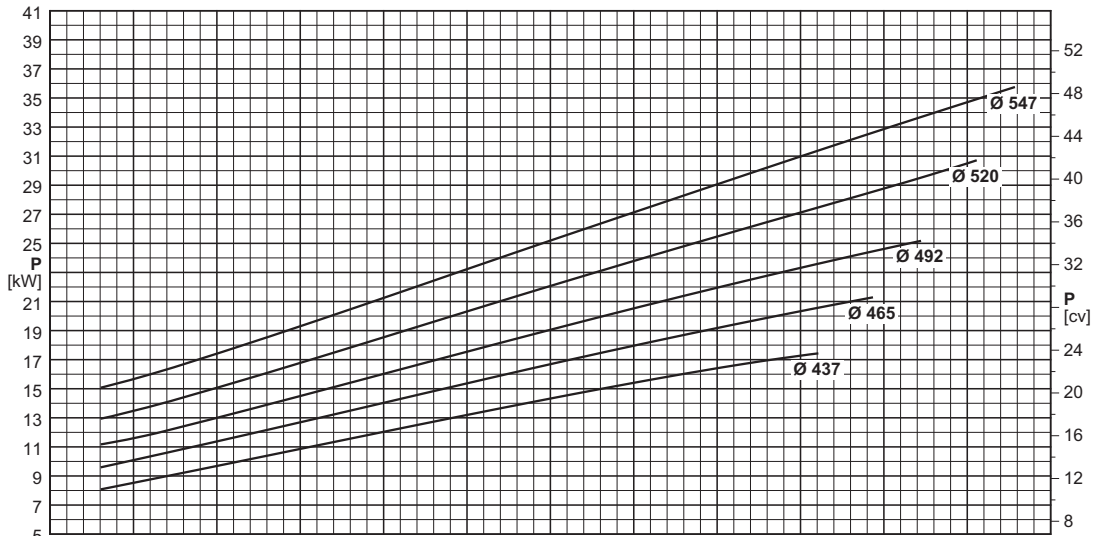
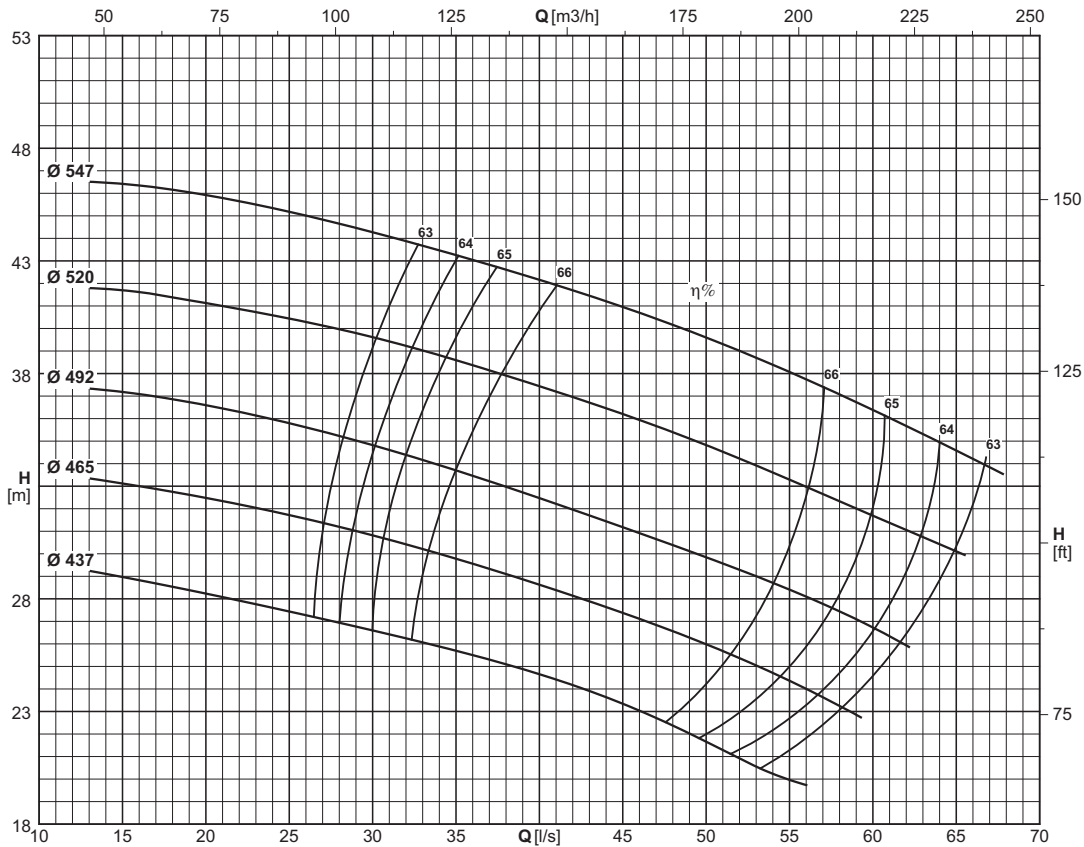

Type Type Tipo	Inlet maximum pressure (*) Pression maximale en aspiration (*) Pressione massima in aspirazione (*)	Dynamic momentum J Momentum dynamique J Momento dinamico J	
		With cast iron impellers Avec roues en fonte Con giranti in ghisa	With AISI 316 impellers Avec roues en AISI 316 Con giranti in AISI 316
	[bar]	J=1/2 PD ² [kgm ²]	
NCH125-500	4.5	-	(F) -

(*) Value referred to the impeller with maximum diameter. (*) Valeur se référant à la roue à ailettes avec le diamètre maximum. (*) Valore riferito alla girante con diametro massimo

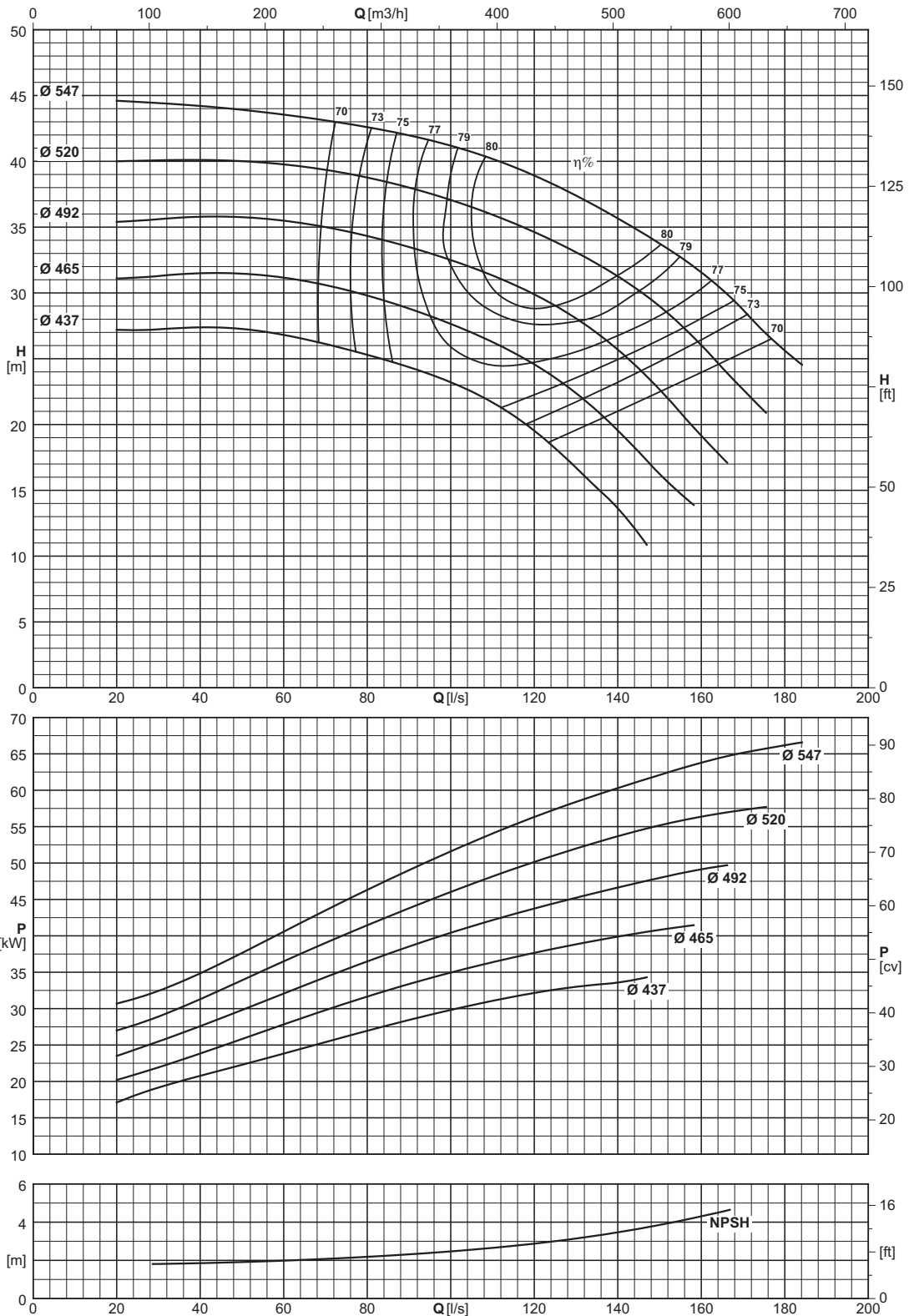

Type Type Tipo	Inlet maximum pressure (*) Pression maximale en aspiration (*) Pressione massima in aspirazione (*)	Dynamic momentum J Momentum dynamique J Momento dinamico J	
		With cast iron impellers Avec roues en fonte Con giranti in ghisa	With AISI 316 impellers Avec roues en AISI 316 Con giranti in AISI 316
		J = 1/4 PD ²	
	[bar]	[kgm ²]	[kgm ²]
NCH200-500	4.5	-	(F) -

(*) Value referred to the impeller with maximum diameter. (*) Valeur se référant à la roue à ailettes avec le diamètre maximum. (*) Valore riferito alla girante con diametro massimo

NCH 250-250

950 n [min⁻¹]

caprari

Operating data
Caracteristiques de fonctionnement
Caratteristiche di funzionamento

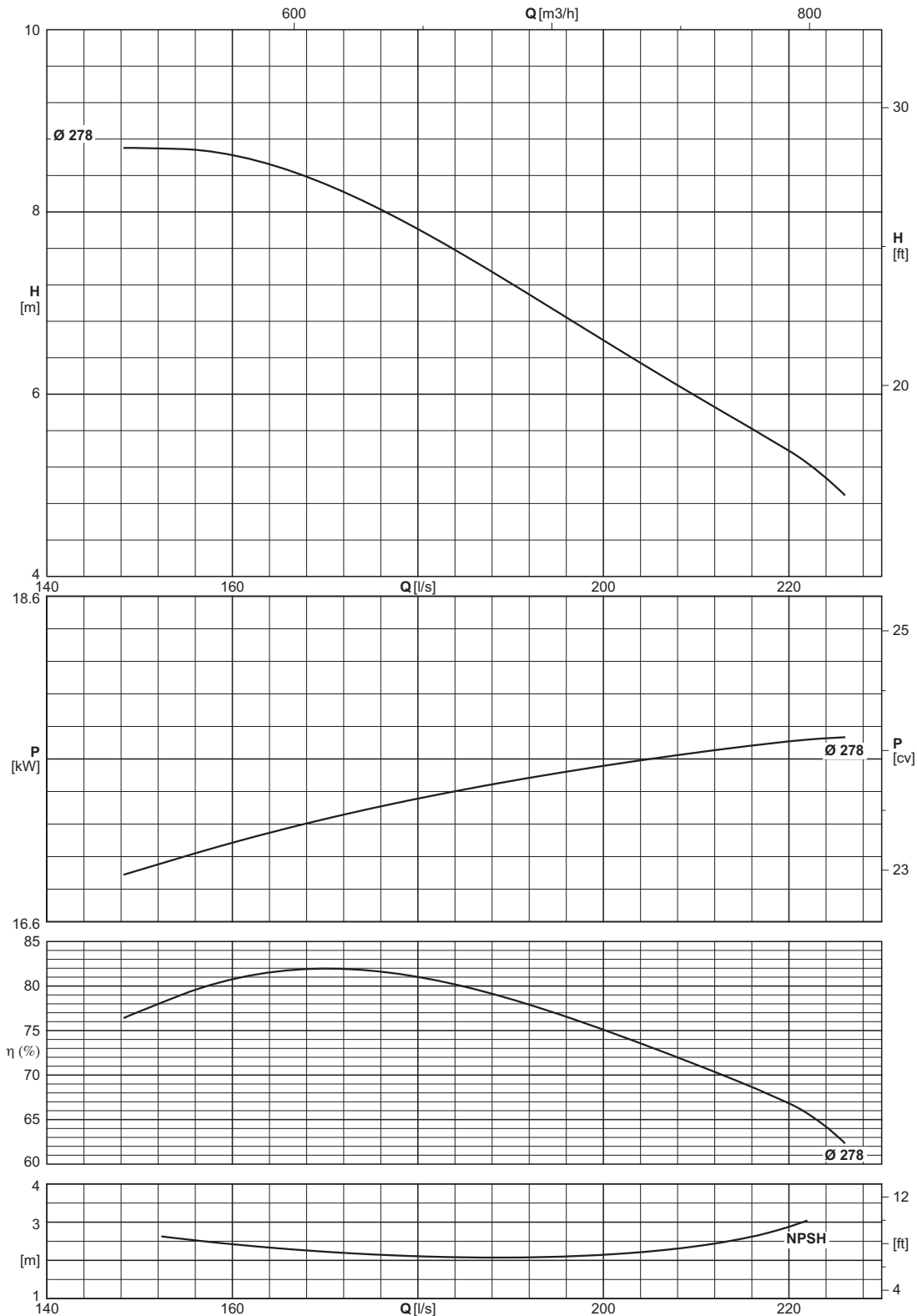

Type Type Tipo	Inlet maximum pressure (*) Pression maximale en aspiration (*) Pressione massima in aspirazione (*)	Dynamic momentum J Momentum dynamique J Momento dinamico J	
		With cast iron impellers Avec roues en fonte Con giranti in ghisa	With AISI 316 impellers Avec roues en AISI 316 Con giranti in AISI 316
		J=1/4PD ²	
	[bar]	[kgm ²]	
NCH250-250	8	-	(F) -

(*) Value referred to the impeller with maximum diameter. (*) Valeur se référant à la roue à ailettes avec le diamètre maximum. (*) Valore riferito alla girante con diametro massimo

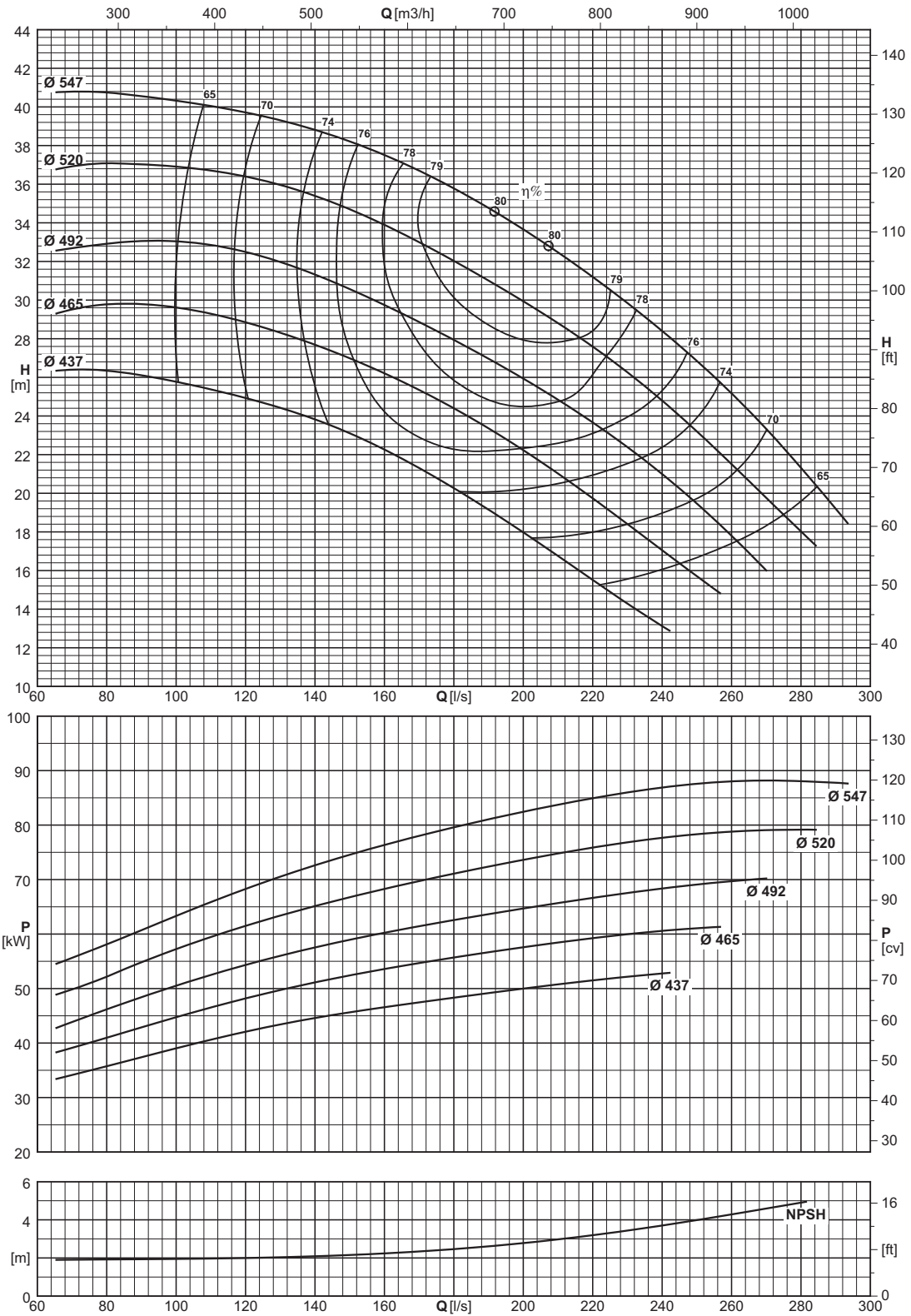

Type Type Tipo	Inlet maximum pressure (*) Pression maximale en aspiration (*) Pressione massima in aspirazione (*)	Dynamic momentum J Momentum dynamique J Momento dinamico J	
		With cast iron impellers Avec roues en fonte Con giranti in ghisa	With AISI 316 impellers Avec roues en AISI 316 Con giranti in AISI 316
		$J = \frac{1}{4}PD^2$	
	[bar]	[kgm ²]	
NCHF250-500	5	-	(F) -

(*) Value referred to the impeller with maximum diameter. (*) Valeur se référant à la roue à ailettes avec le diamètre maximum. (*) Valore riferito alla girante con diametro massimo

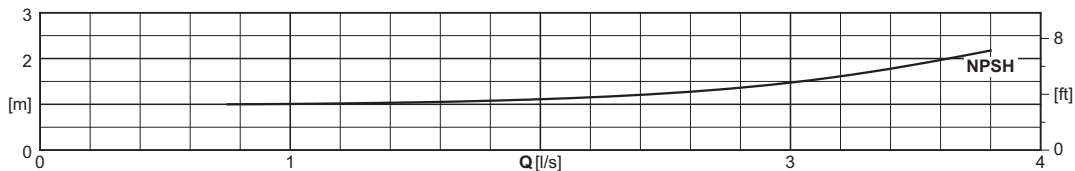
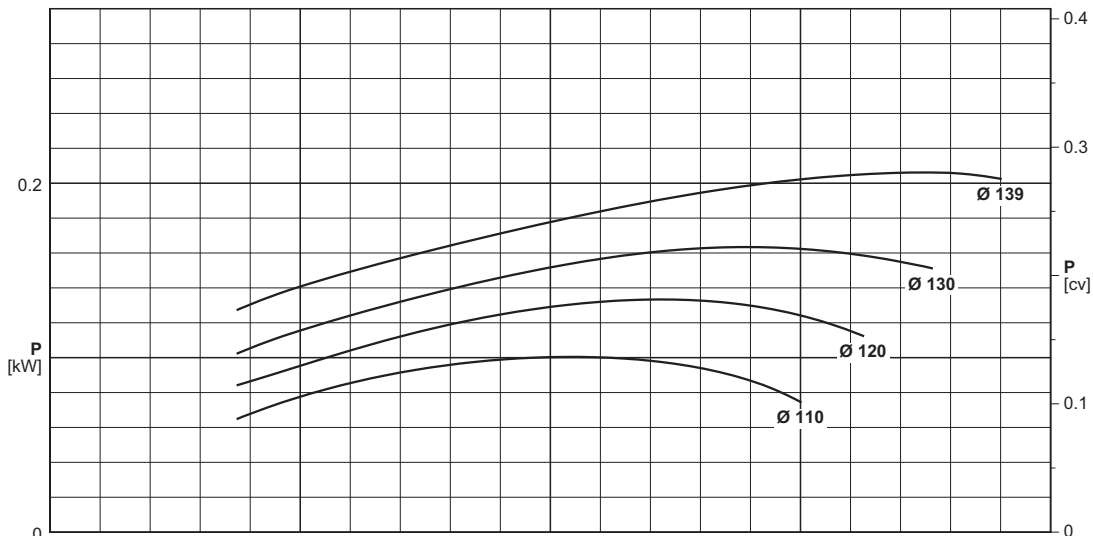
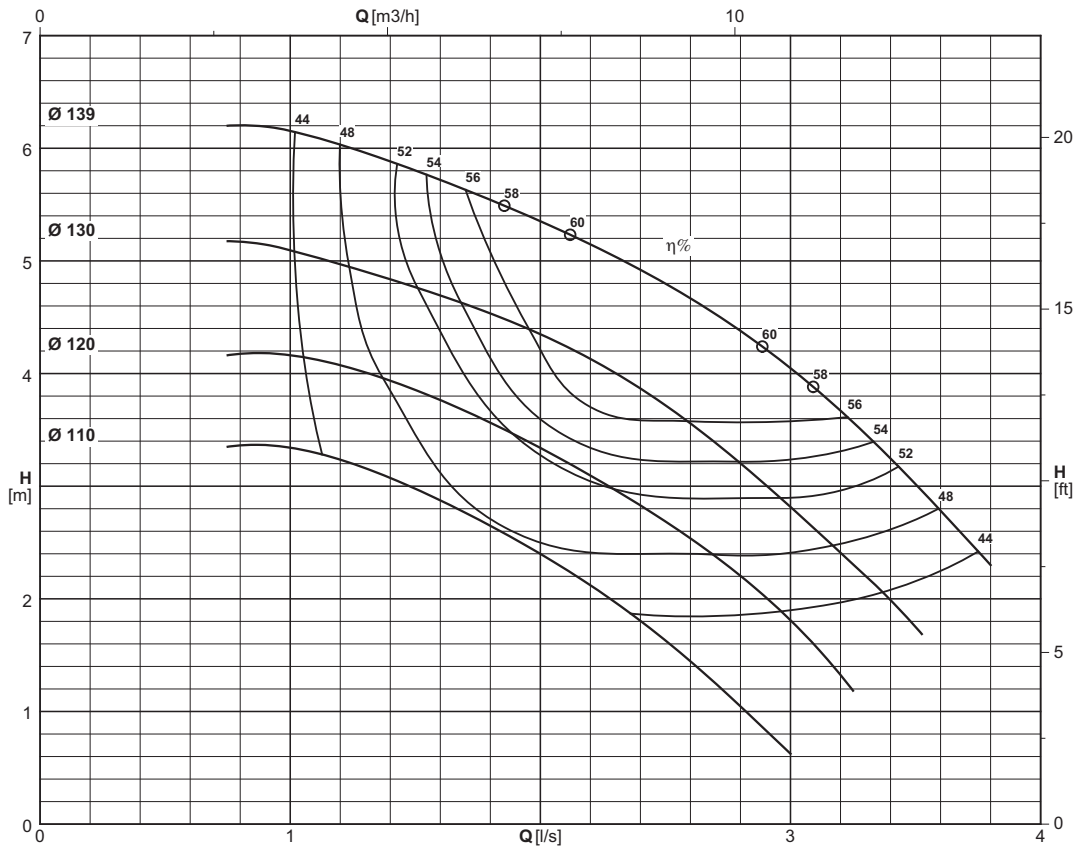

Type Type Tipo	Inlet maximum pressure (*) <i>Pression maximale en aspiration (*)</i> <i>Pressione massima in aspirazione (*)</i>	Dinamic momentum J <i>Momentum dynamique J</i> Momento dinamico J	
		With cast iron impellers <i>Avec roues en fonte</i> Con giranti in ghisa	With AISI 316 impellers <i>Avec roues en AISI 316</i> Con giranti in AISI 316
		$J = \frac{1}{2} \rho D^5 n^3$	
	[bar]	[kgm ²]	
NC32-125	8	0,00290	(F) 0,00318

Construction reference standard EN733 (DIN24255)

Norme de référence construction EN733 (DIN24255)

Norma di riferimento costruttivo EN733 (DIN24255)

(*) Value referred to the impeller with maximum diameter.

(*) *Valeur se référant à la roue à ailettes avec le diamètre maximum.*

(*) **Valore riferito alla girante con diametro massimo**

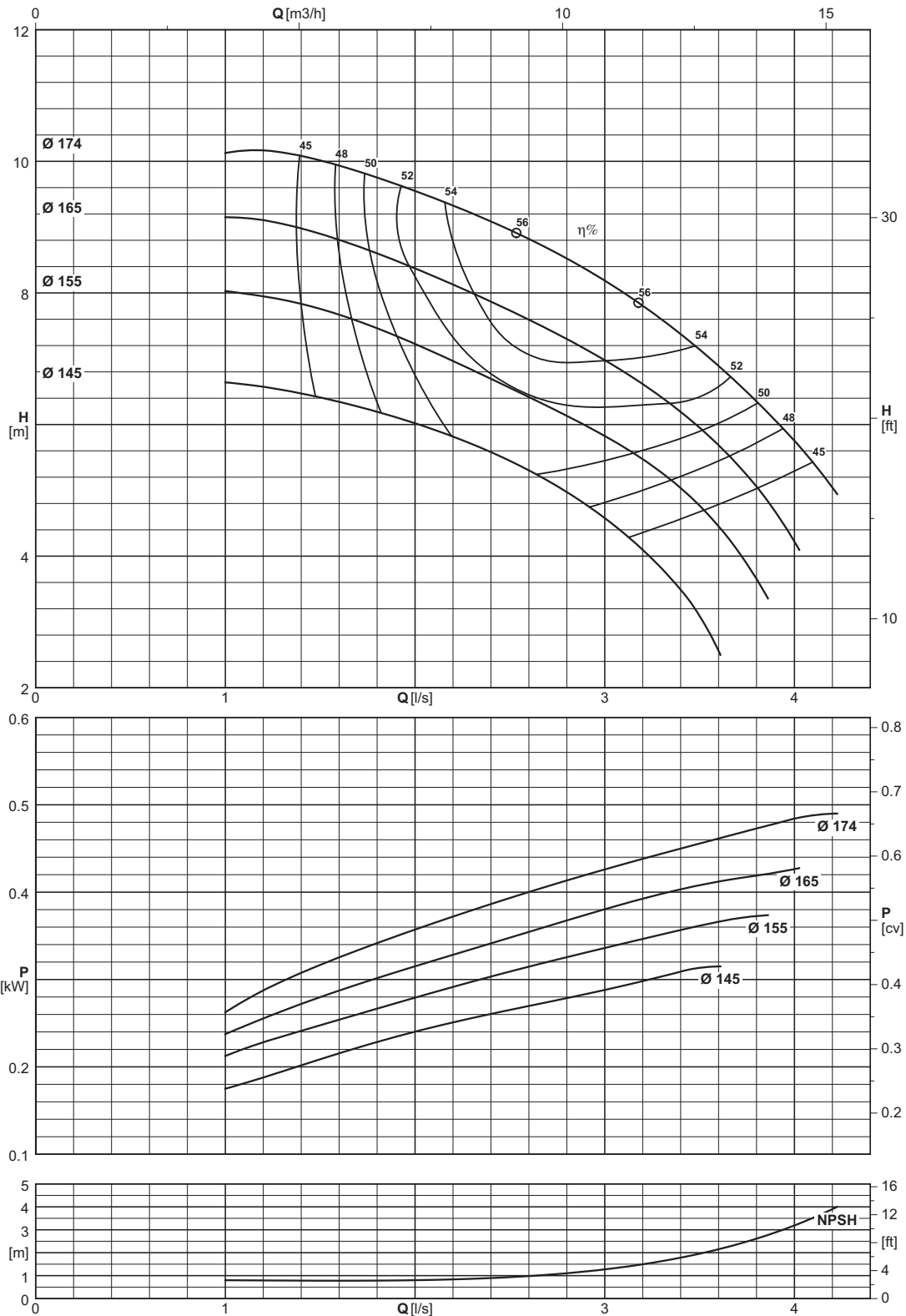

Type Type Tipo	Inlet maximum pressure (*) Pression maximale en aspiration (*) Pressione massima in aspirazione (*)	Dynamic momentum J Momentum dynamique J Momento dinamico J	
		With cast iron impellers Avec roues en fonte Con giranti in ghisa	With AISI 316 impellers Avec roues en AISI 316 Con giranti in AISI 316
		J=1/4PD ²	
	[bar]	[kgm ²]	
NC32-160	8	0,01015	(F) 0,01112

Construction reference standard EN733 (DIN24255)

Norme de référence construction EN733 (DIN24255)

Norma di riferimento costruttivo EN733 (DIN24255)

(*) Value referred to the impeller with maximum diameter.

(*) Valeur se référant à la roue à ailettes avec le diamètre maximum.

(*) Valore riferito alla girante con diametro massimo

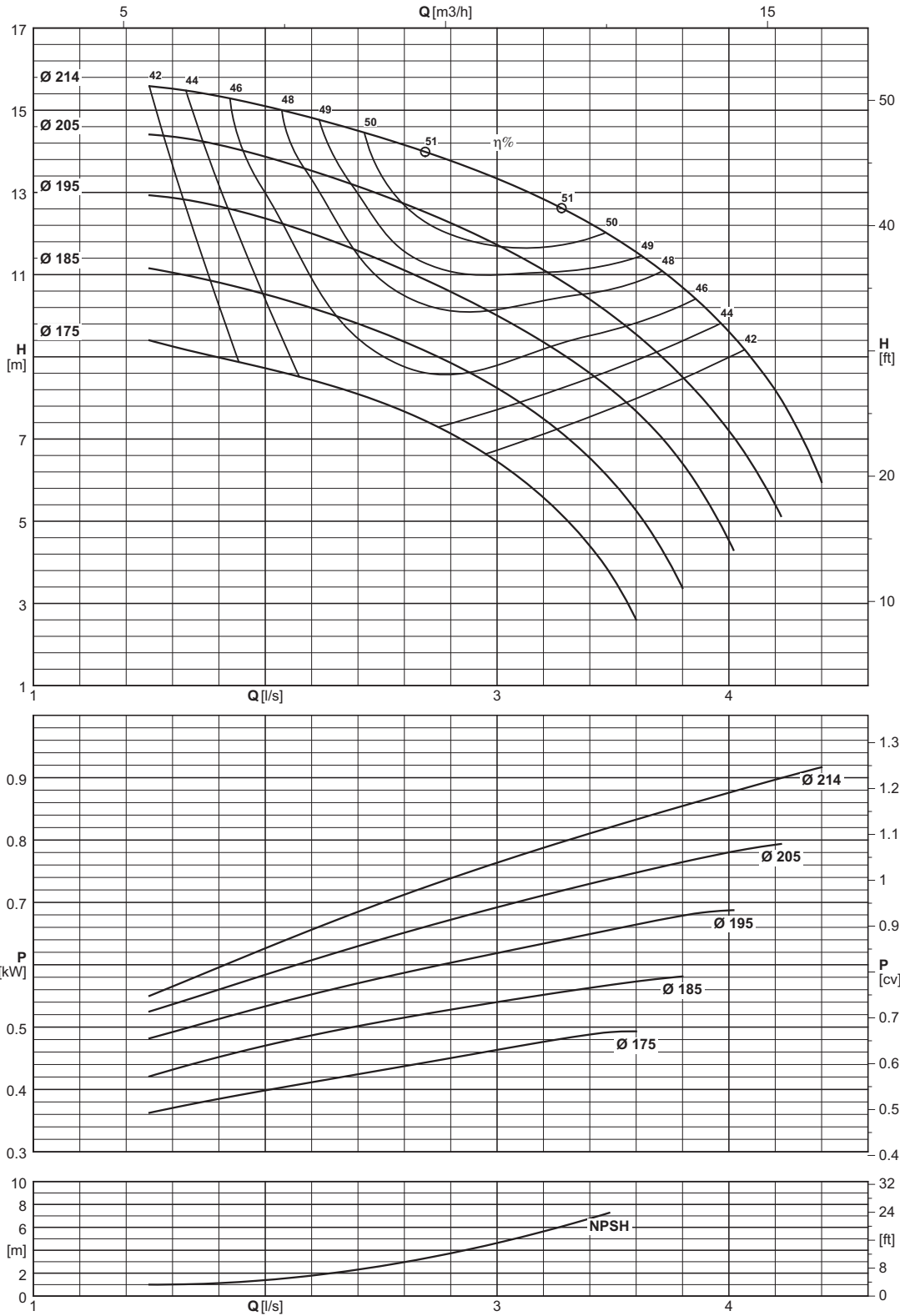

Type Type Tipo	Inlet maximum pressure (*) Pression maximale en aspiration (*) Pressione massima in aspirazione (*)	Dinamic momentum J Momentum dynamique J Momento dinamico J	
		With cast iron impellers Avec roues en fonte Con giranti in ghisa	With AISI 316 impellers Avec roues en AISI 316 Con giranti in AISI 316
		J=1/4PD ²	
	[bar]	[kgm ²]	[kgm ²]
NC32-200	7	0,02301	(F) 0,02520

Construction reference standard EN733 (DIN24255)

Norme de référence construction EN733 (DIN24255)

Norma di riferimento costruttivo EN733 (DIN24255)

(*) Value referred to the impeller with maximum diameter.

(*) Valeur se référant à la roue à ailettes avec le diamètre maximum.

(*) Valore riferito alla girante con diametro massimo

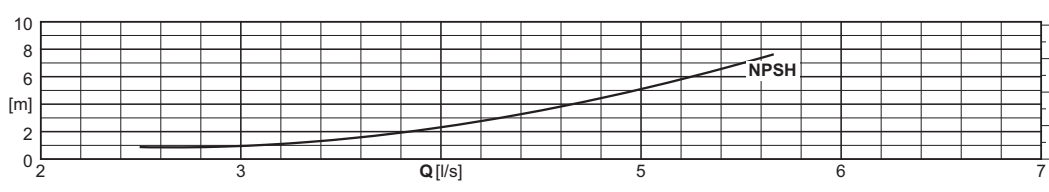
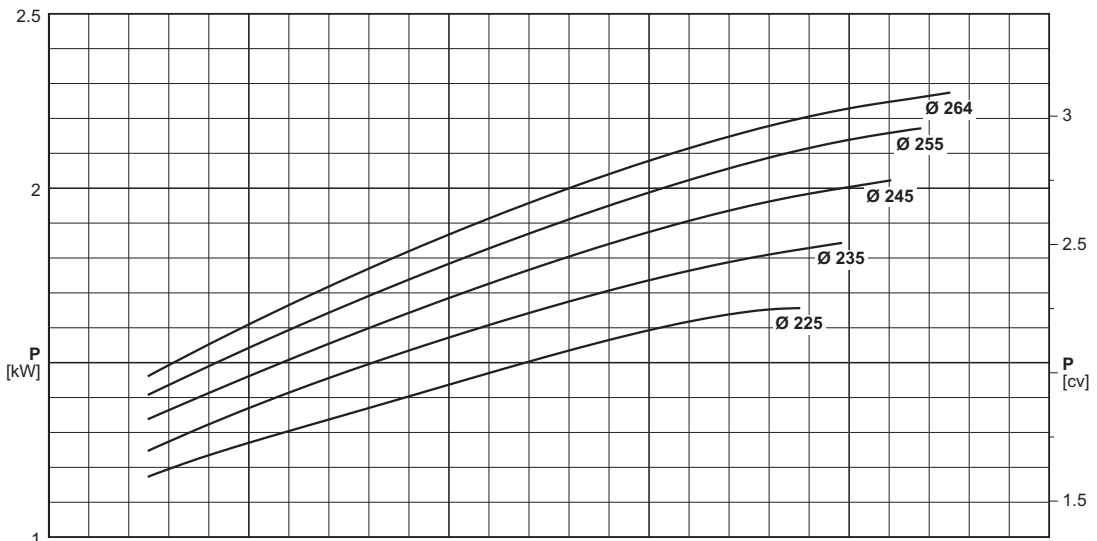
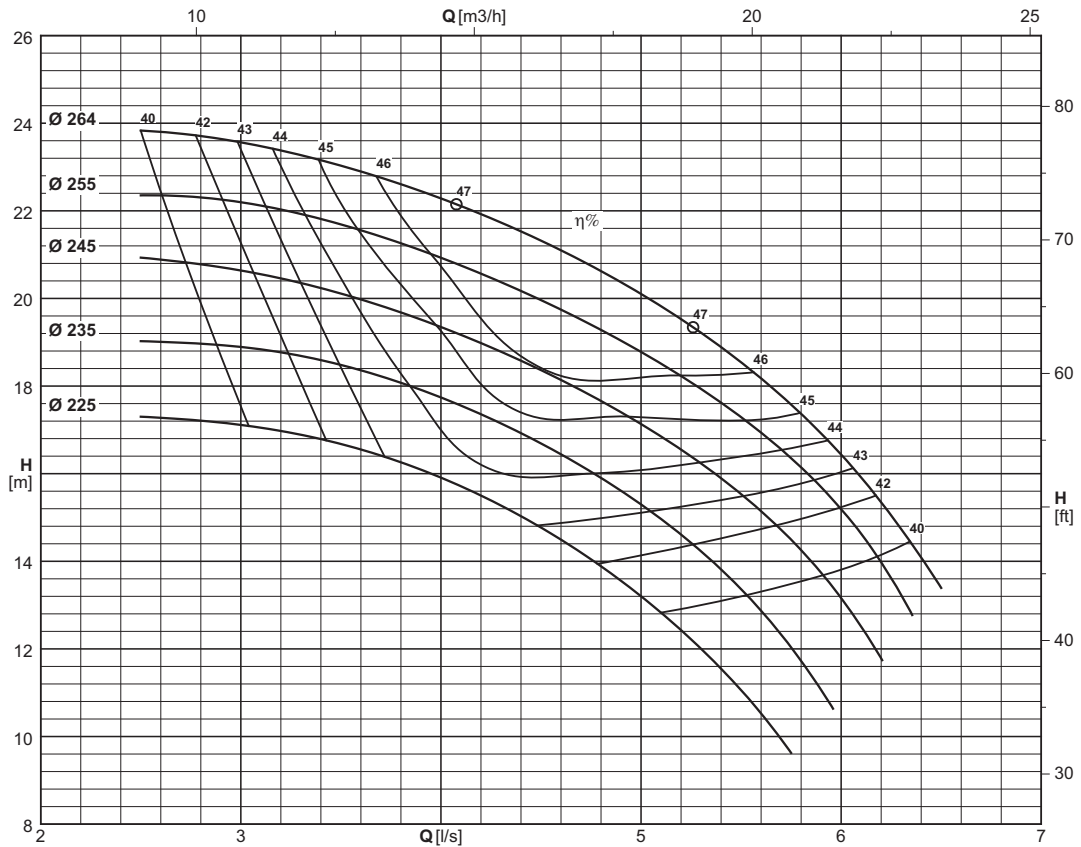

Type Type Tipo	Inlet maximum pressure (*) Pression maximale en aspiration (*) Pressione massima in aspirazione (*)	Dynamic momentum J Momentum dynamique J Momento dinamico J	
		With cast iron impellers Avec roues en fonte Con giranti in ghisa	With AISI 316 impellers Avec roues en AISI 316 Con giranti in AISI 316
		J=1/4PD²	
	[bar]	[kgm²]	
NC32-250	6	0,04321	(F) 0,04731

(*) Value referred to the impeller with maximum diameter. (*) Valeur se référant à la roue à ailettes avec le diamètre maximum. (*) Valore riferito alla girante con diametro massimo

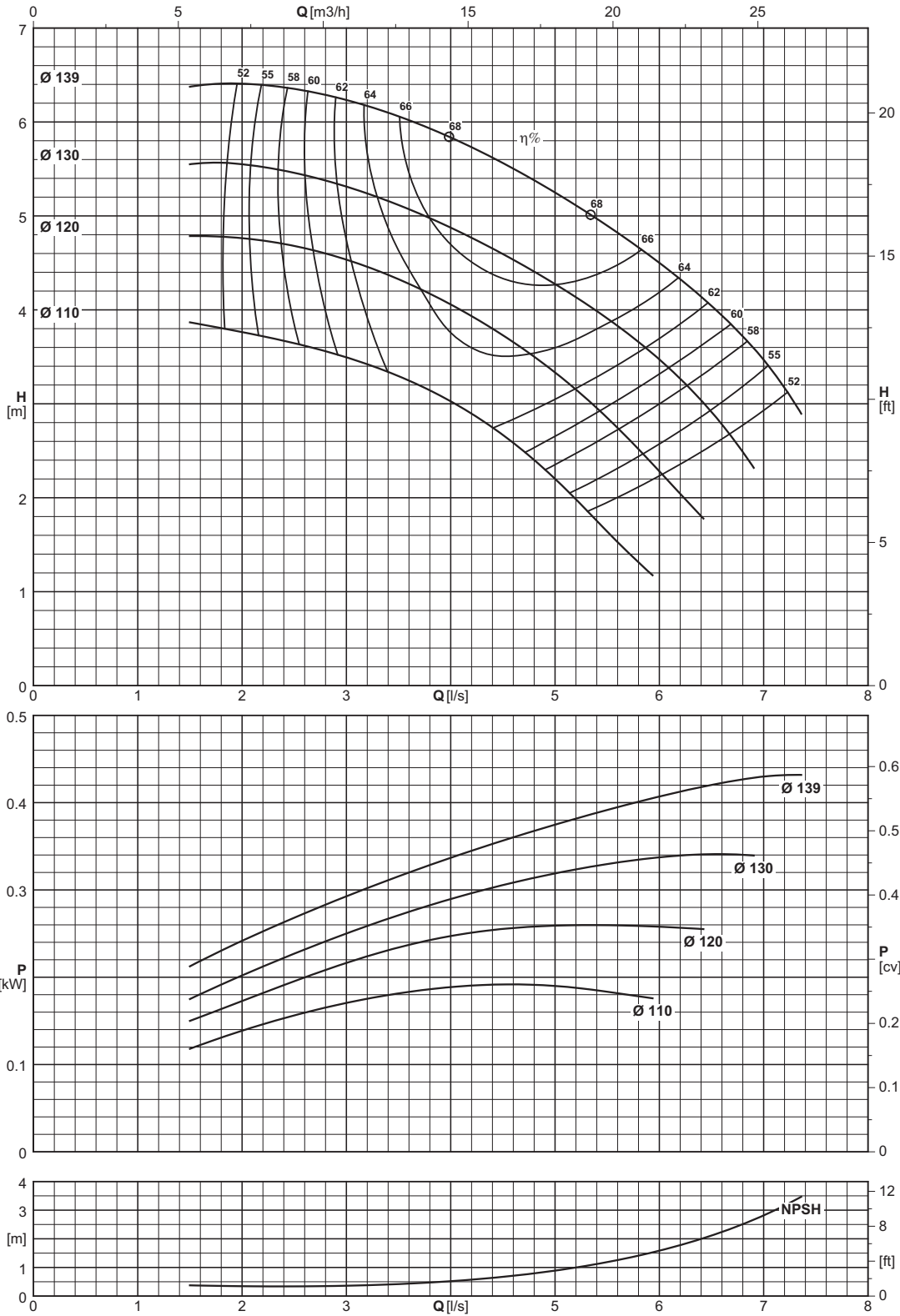

Type Type Tipo	Inlet maximum pressure (*) <i>Pression maximale en aspiration (*)</i> <i>Pressione massima in aspirazione (*)</i>	Dynamic momentum J <i>Momentum dynamique J</i> <i>Momento dinamico J</i>	
		With cast iron impellers <i>Avec roues en fonte</i> <i>Con giranti in ghisa</i>	With AISI 316 impellers <i>Avec roues en AISI 316</i> <i>Con giranti in AISI 316</i>
		J = 1/4 PD ²	
	[bar]	[kgm ²]	
NC40-125	8	0,00429	(F) 0,01104

Construction reference standard EN733 (DIN24255)
 (*) Value referred to the impeller with maximum diameter.

Norme de référence construction EN733 (DIN24255)
 (*) *Valeur se référant à la roue à ailettes avec le diamètre maximum.*

Norma di riferimento costruttivo EN733 (DIN24255)
 (*) *Valore riferito alla girante con diametro massimo*

Operating data
Caracteristiques de fonctionnement
Caratteristiche di funzionamento

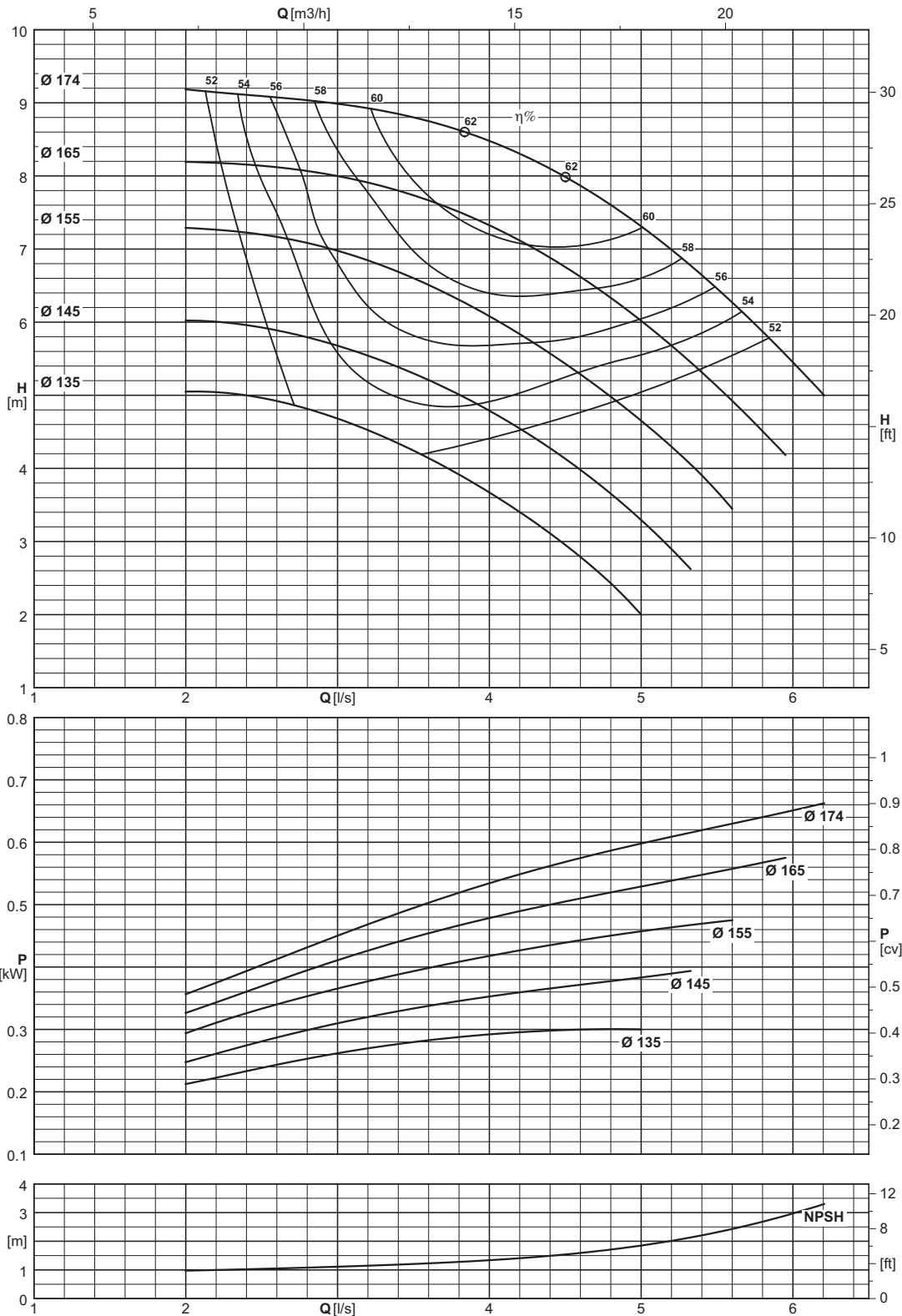

Type Type Tipo	Inlet maximum pressure (*) Pression maximale en aspiration (*) Pressione massima in aspirazione (*)	Dynamic momentum J Momentum dynamique J Momento dinamico J	
		With cast iron impellers Avec roues en fonte Con giranti in ghisa	With AISI 316 impellers Avec roues en AISI 316 Con giranti in AISI 316
		J=1/4PD²	
	[bar]	[kgm²]	[kgm²]
NC40-160	8	0,01104	(F) 0,01209

Construction reference standard EN733 (DIN24255)
(*) Value referred to the impeller with maximum diameter.

Norme de référence construction EN733 (DIN24255)
(*) Valeur se référant à la roue à ailettes avec le diamètre maximum.

Norma di riferimento costruttivo EN733 (DIN24255)
(*) Valore riferito alla girante con diametro massimo

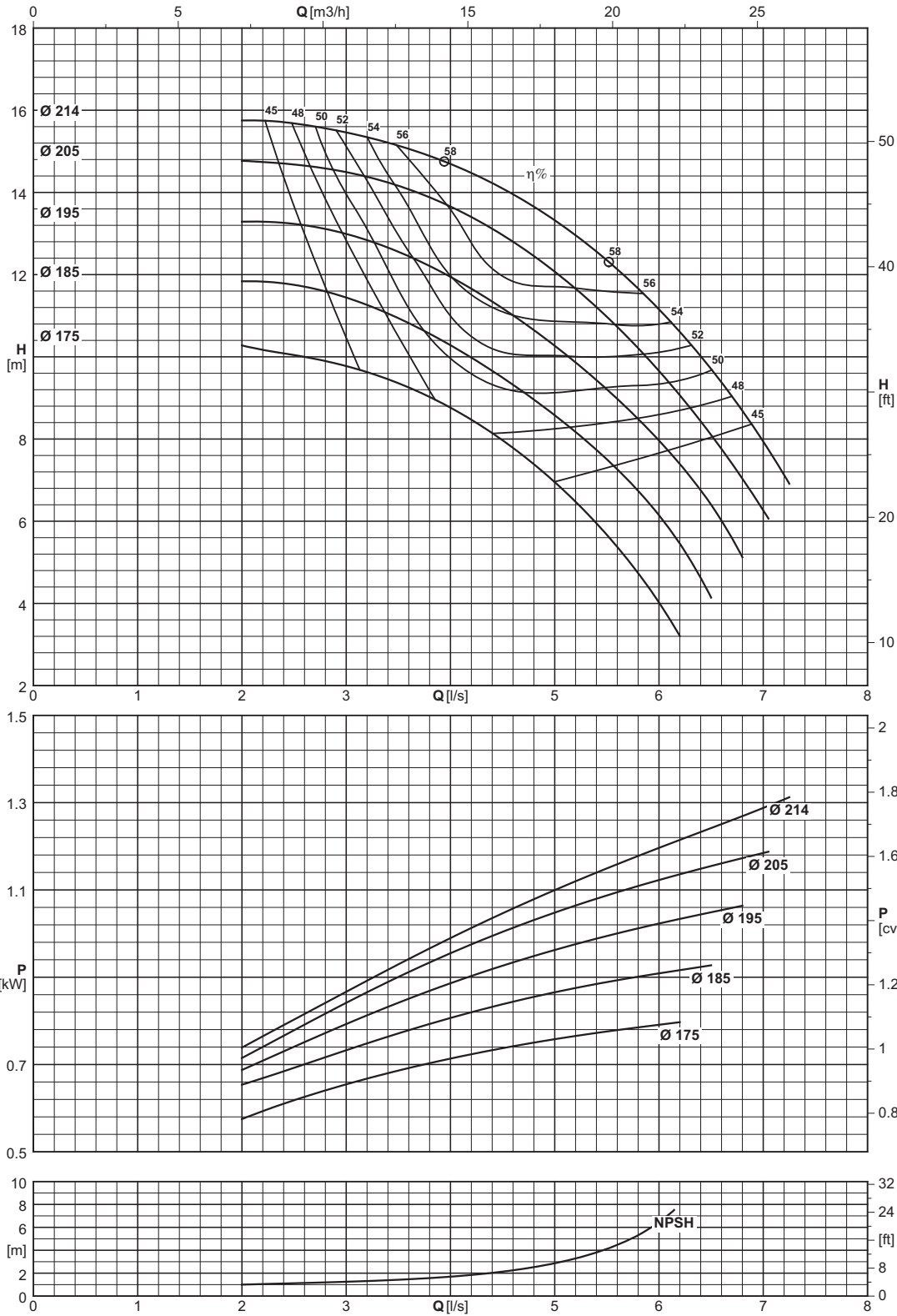

Type Type Tipo	Inlet maximum pressure (*) Pression maximale en aspiration (*) Pressione massima in aspirazione (*)	Dinamic momentum J Momentum dynamique J Momento dinamico J	
		With cast iron impellers Avec roues en fonte Con giranti in ghisa	With AISI 316 impellers Avec roues en AISI 316 Con giranti in AISI 316
	[bar]	J = 1/4 PD ² [kgm ²]	
NC40-200	7	0,02742	(F) 0,03002

Construction reference standard EN733 (DIN24255)
(*) Value referred to the impeller with maximum diameter.

Norme de référence construction EN733 (DIN24255)
(*) Valeur se référant à la roue à ailettes avec le diamètre maximum.

Norma di riferimento costruttivo EN733 (DIN24255)
(*) Valore riferito alla girante con diametro massimo

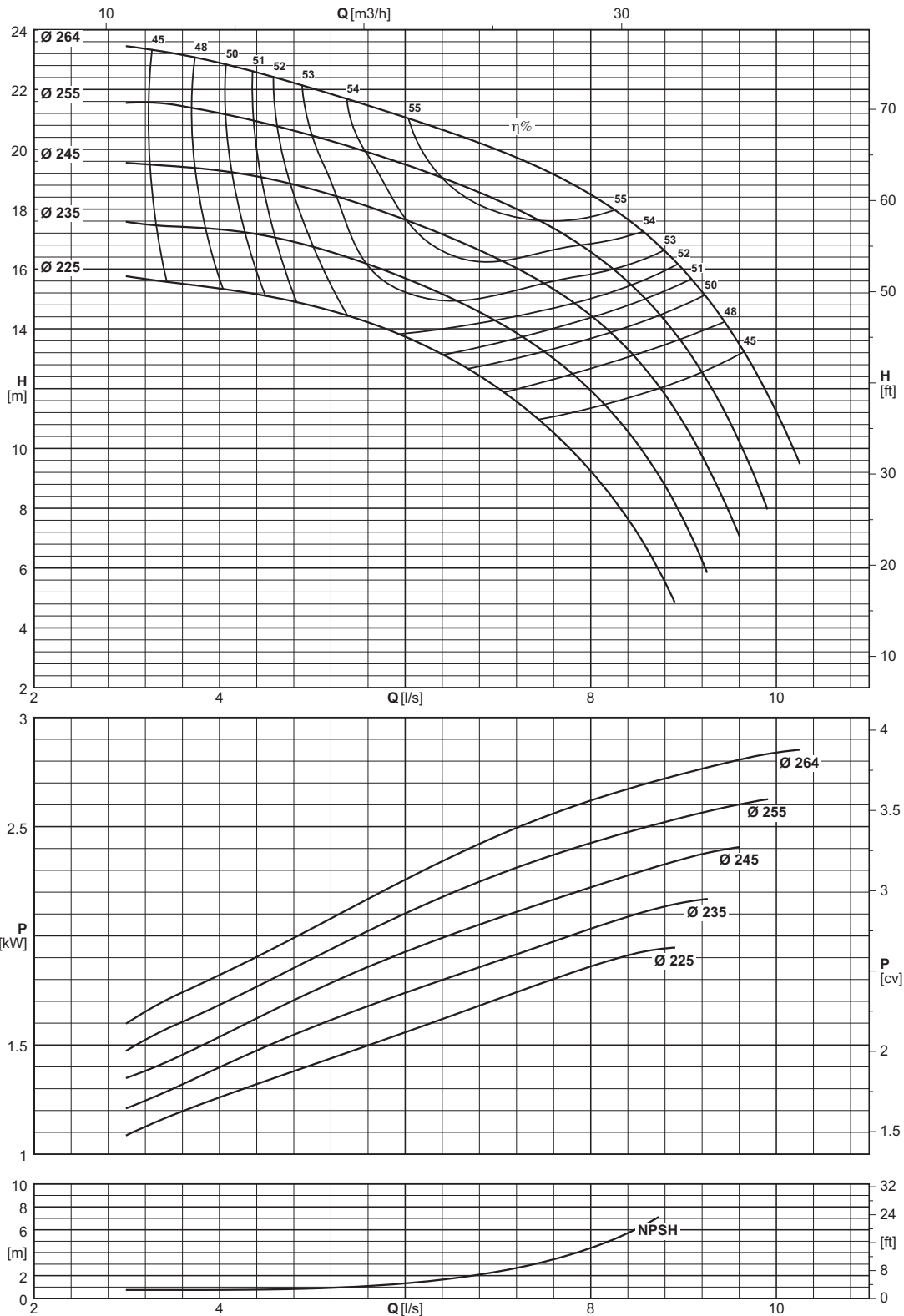

Type Type Tipo	Inlet maximum pressure (*) Pression maximale en aspiration (*) Pressione massima in aspirazione (*)	Dynamic momentum J Momentum dynamique J Momento dinamico J	
		With cast iron impellers Avec roues en fonte Con giranti in ghisa	With AISI 316 impellers Avec roues en AISI 316 Con giranti in AISI 316
		J=1/4PD ²	
	[bar]	[kgm ²]	[kgm ²]
NC40-250	6	0,04818	(F) 0,05276

Construction reference standard EN733 (DIN24255)
(*) Value referred to the impeller with maximum diameter.

Norme de référence construction EN733 (DIN24255)
(*) Valeur se référant à la roue à ailettes avec le diamètre maximum.

Norma di riferimento costruttivo EN733 (DIN24255)
(*) Valore riferito alla girante con diametro massimo

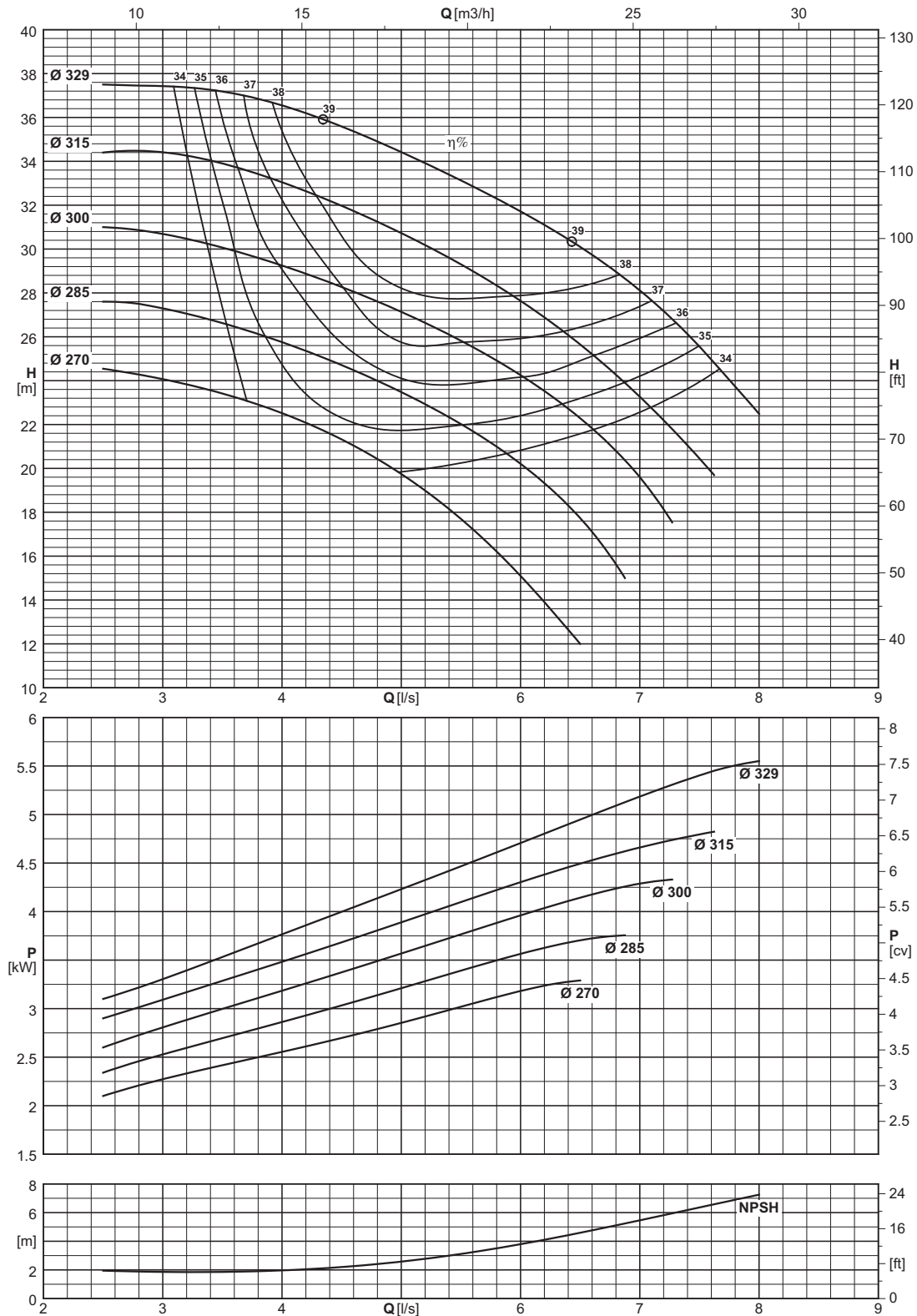

Type Type Tipo	Inlet maximum pressure (*) Pression maximale en aspiration (*) Pressione massima in aspirazione (*)	Dinamic momentum J Momentum dynamique J Momento dinamico J	
		With cast iron impellers Avec roues en fonte Con giranti in ghisa	With AISI 316 impellers Avec roues en AISI 316 Con giranti in AISI 316
		J=1/4PD²	
	[bar]	[kgm²]	[kgm²]
NC40-315	5	0,08800	(F) 0,09636

(*) Value referred to the impeller with maximum diameter.

(*) Valeur se référant à la roue à ailettes avec le diamètre maximum.

(*) Valore riferito alla girante con diametro massimo

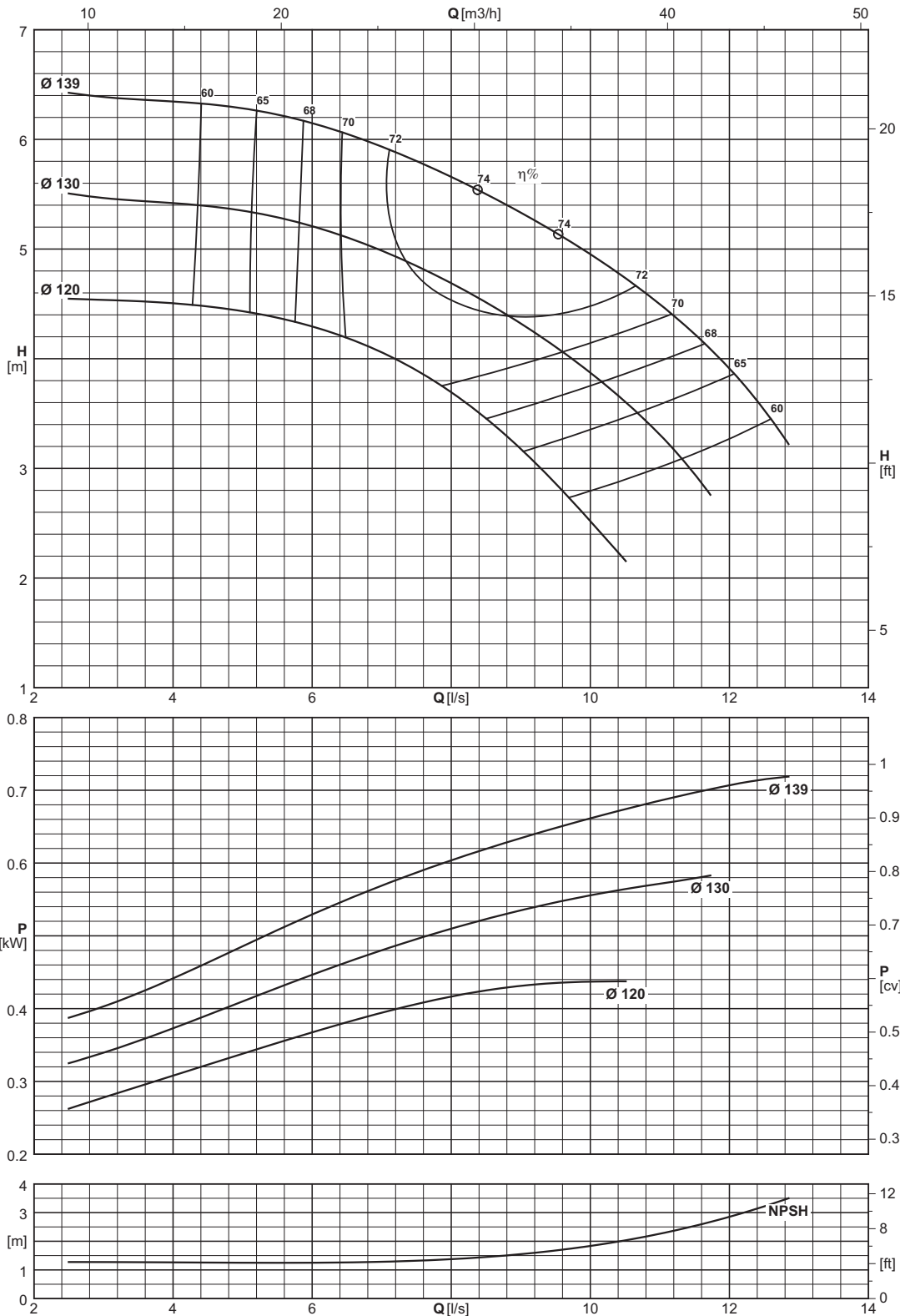

Type Type Tipo	Inlet maximum pressure (*) Pression maximale en aspiration (*) Pressione massima in aspirazione (*)	Dynamic momentum J Momentum dynamique J Momento dinamico J	
		With cast iron impellers Avec roues en fonte Con giranti in ghisa	With AISI 316 impellers Avec roues en AISI 316 Con giranti in AISI 316
		J=1/4PD ²	
	[bar]	[kgm ²]	
NC50-125	8	0,00495	(F) 0,00542

Construction reference standard EN733 (DIN24255)
(*) Value referred to the impeller with maximum diameter.

Norme de référence construction EN733 (DIN24255)
(*) Valeur se référant à la roue à ailettes avec le diamètre maximum.

Norma di riferimento costruttivo EN733 (DIN24255)
(*) Valore riferito alla girante con diametro massimo

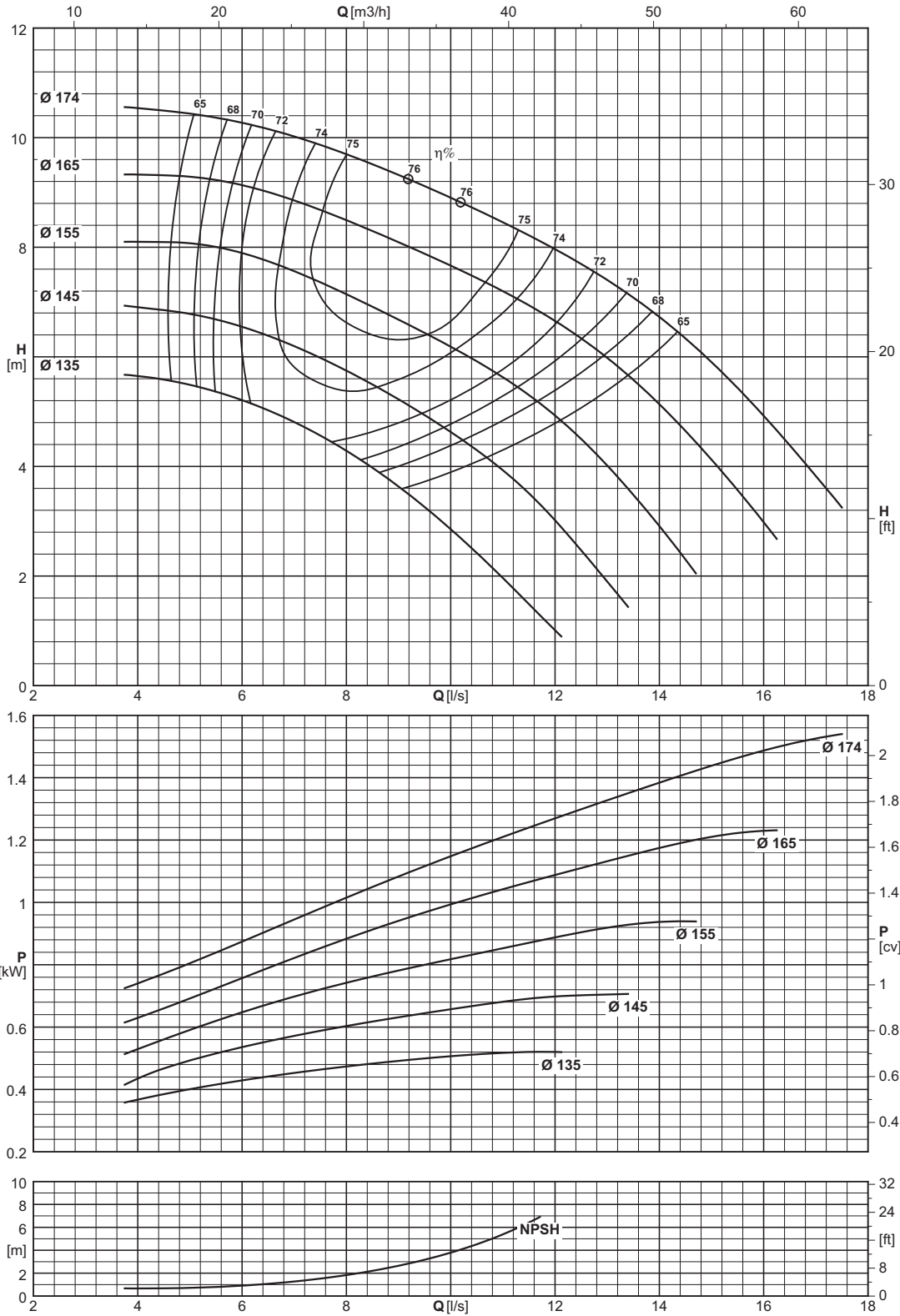

Type Type Tipo	Inlet maximum pressure (*) Pression maximale en aspiration (*) Pressione massima in aspirazione (*)	Dinamic momentum J Momentum dynamique J Momento dinamico J	
		With cast iron impellers Avec roues en fonte Con giranti in ghisa	With AISI 316 impellers Avec roues en AISI 316 Con giranti in AISI 316
		J=1/4PD ²	
	[bar]	[kgm ²]	
NC50-160	8	0,01193	(F) 0,01307

Construction reference standard EN733 (DIN24255)
(*) Value referred to the impeller with maximum diameter.

Norme de référence construction EN733 (DIN24255)
(*) Valeur se référant à la roue à ailettes avec le diamètre maximum.

Norma di riferimento costruttivo EN733 (DIN24255)
(*) Valore riferito alla girante con diametro massimo

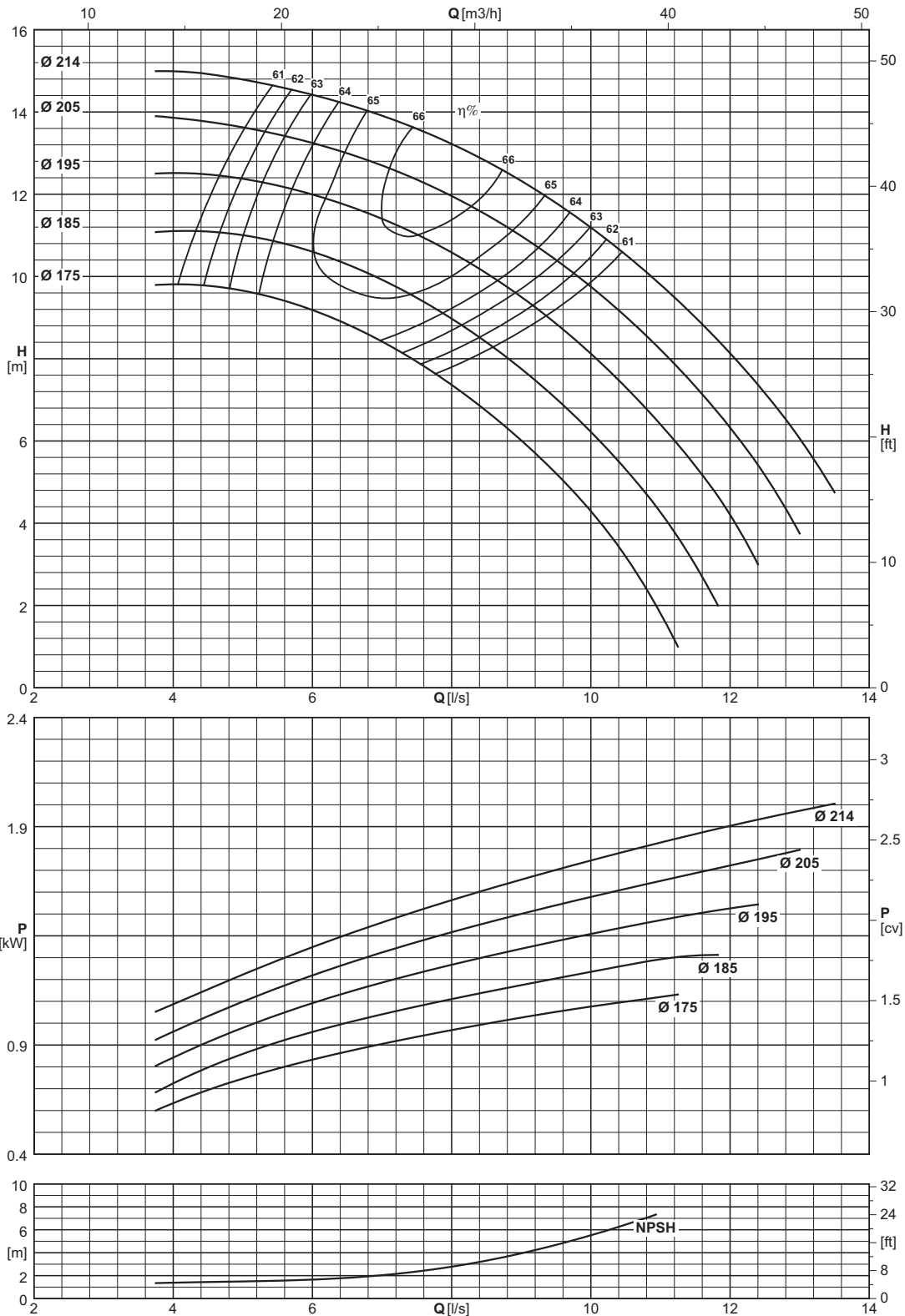

Type Type Tipo	Inlet maximum pressure (*) Pression maximale en aspiration (*) Pressione massima in aspirazione (*)	Dynamic momentum J Momentum dynamique J Momento dinamico J	
		With cast iron impellers Avec roues en fonte Con giranti in ghisa	With AISI 316 impellers Avec roues en AISI 316 Con giranti in AISI 316
		J=1/4PD ²	
	[bar]	[kgm ²]	
NC50-200	7	0,02742	(F) 0,03002

Construction reference standard EN733 (DIN24255)
(*) Value referred to the impeller with maximum diameter.

Norme de référence construction EN733 (DIN24255)
(*) Valeur se référant à la roue à ailettes avec le diamètre maximum.

Norma di riferimento costruttivo EN733 (DIN24255)
(*) Valore riferito alla girante con diametro massimo

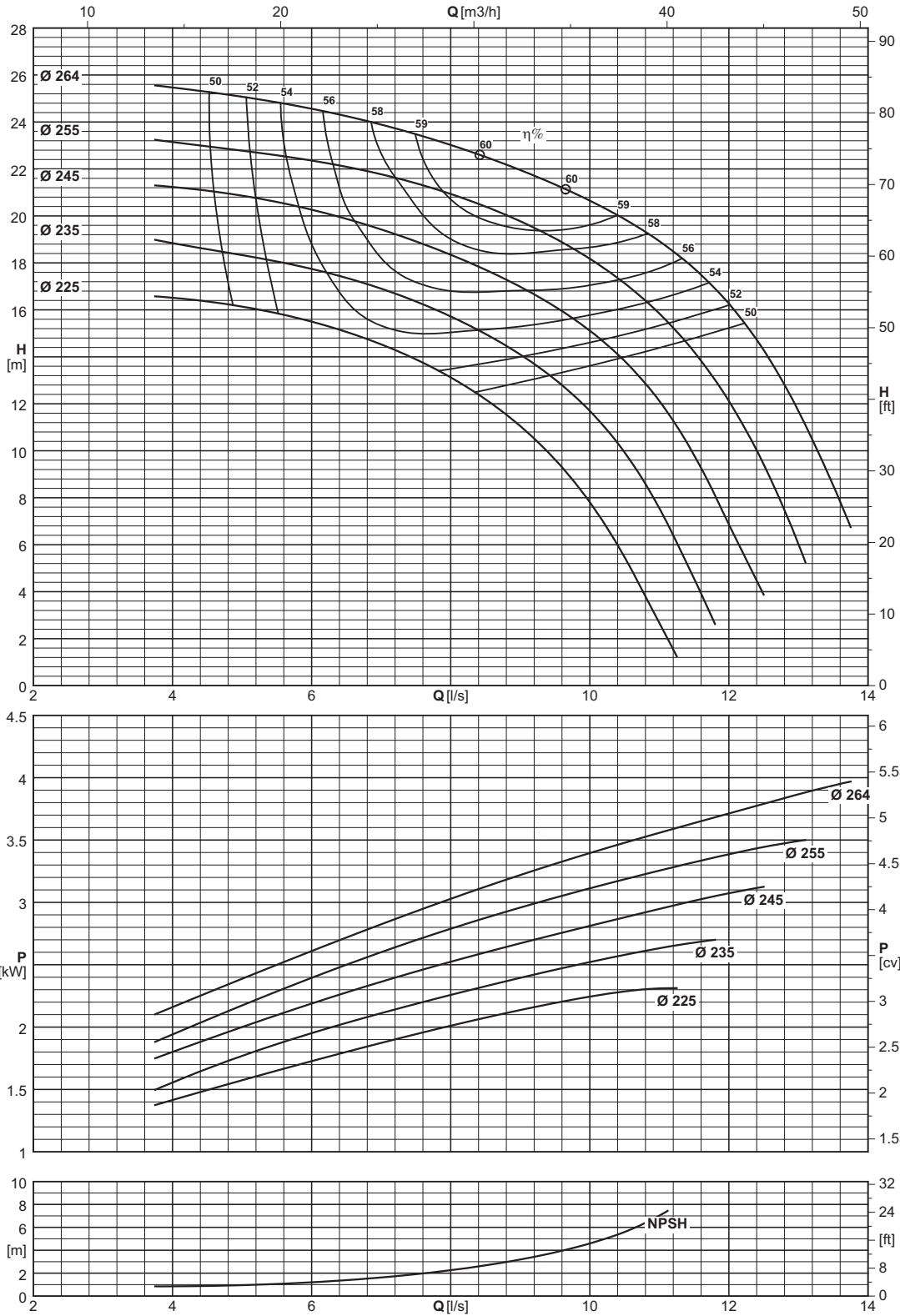

Type Type Tipo	Inlet maximum pressure (*) Pression maximale en aspiration (*) Pressione massima in aspirazione (*)	Dinamic momentum J Momentum dynamique J Momento dinamico J	
		With cast iron impellers Avec roues en fonte Con giranti in ghisa	With AISI 316 impellers Avec roues en AISI 316 Con giranti in AISI 316
		J=1/4 PD ²	
	[bar]	[kgm ²]	[kgm ²]
NC50-250	6	0,05553	(F) 0,06081

Construction reference standard EN733 (DIN24255)
(*) Value referred to the impeller with maximum diameter.

Norme de référence construction EN733 (DIN24255)
(*) Valeur se référant à la roue à ailettes avec le diamètre maximum.

Norma di riferimento costruttivo EN733 (DIN24255)
(*) Valore riferito alla girante con diametro massimo

Operating data
 Caracteristiques de fonctionnement
 Caratteristiche di funzionamento

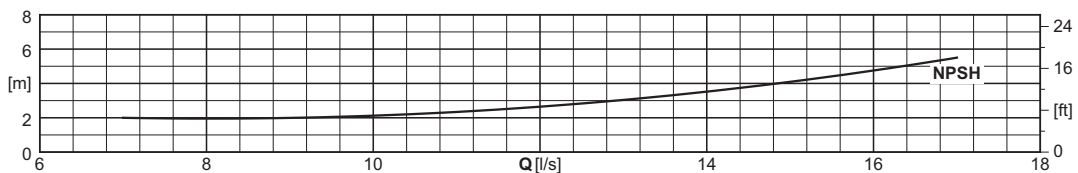
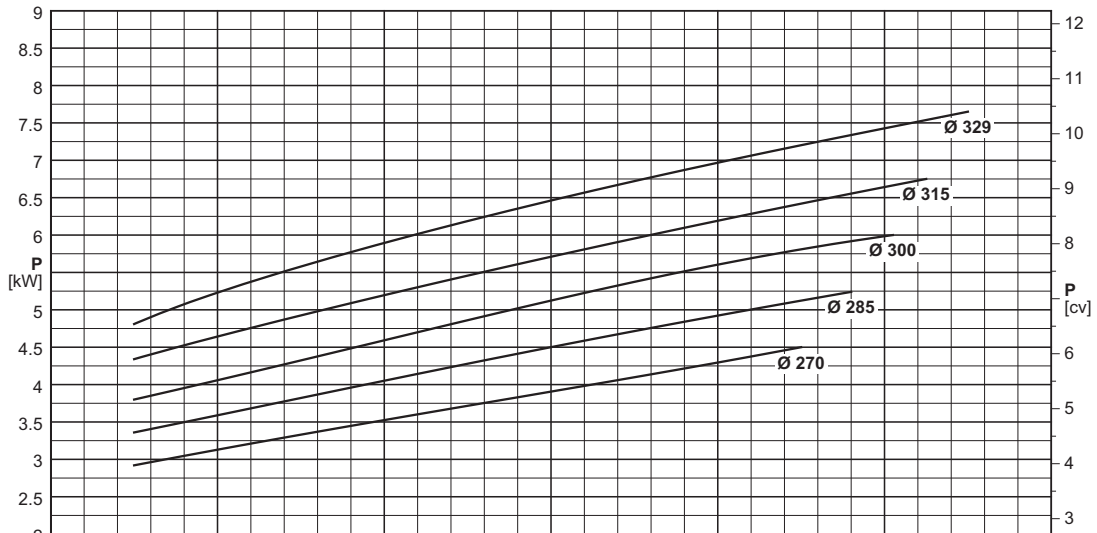
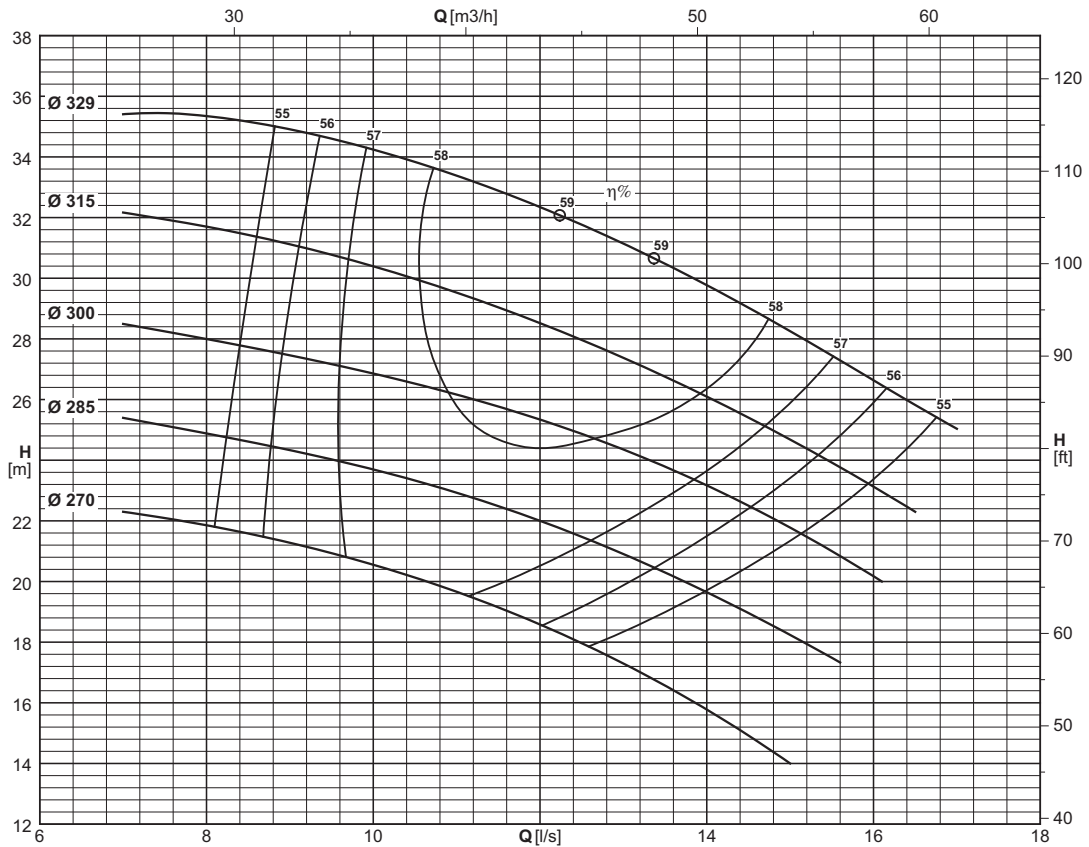

Type Type Tipo	Inlet maximum pressure (*) Pression maximale en aspiration (*) Pressione massima in aspirazione (*)	Dynamic momentum J Momentum dynamique J Momento dinamico J	
		With cast iron impellers Avec roues en fonte Con giranti in ghisa	With AISI 316 impellers Avec roues en AISI 316 Con giranti in AISI 316
		J = 1/4 PD ²	
[bar]		[kgm ²]	
NC50-315	5	0,24010	(F) 0,26291

(*) Value referred to the impeller with maximum diameter.

(*) Valeur se référant à la roue à ailettes avec le diamètre maximum.

(*) Valore riferito alla girante con diametro massimo

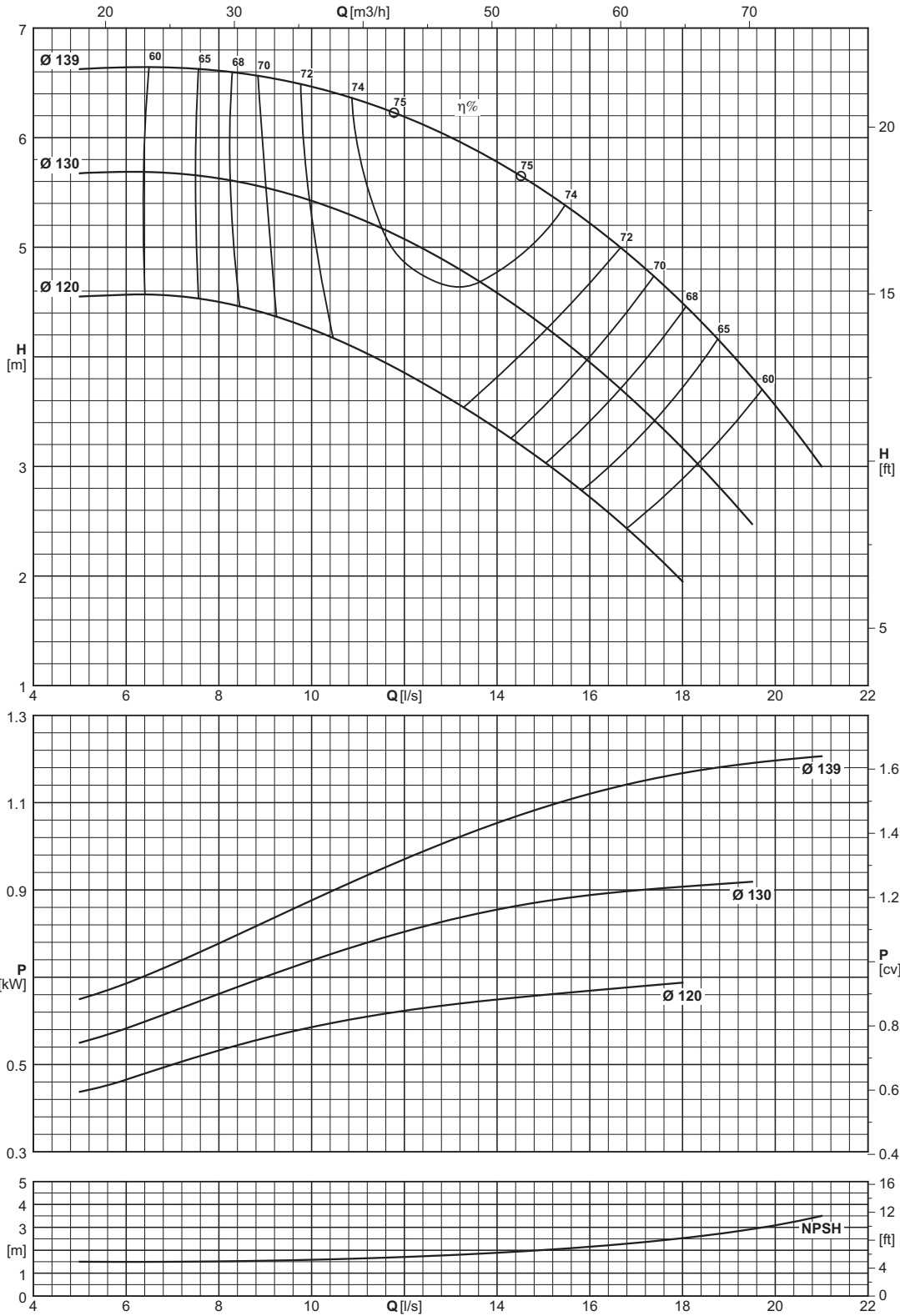

Type Type Tipo	Inlet maximum pressure (*) Pression maximale en aspiration (*) Pressione massima in aspirazione (*)	Dynamic momentum J Momentum dynamique J Momento dinamico J	
		With cast iron impellers Avec roues en fonte Con giranti in ghisa	With AISI 316 impellers Avec roues en AISI 316 Con giranti in AISI 316
		J=1/4PD ²	
	[bar]	[kgm ²]	
NC65-125	8	0,00817	(F) 0,00895

Construction reference standard EN733 (DIN24255)
(*) Value referred to the impeller with maximum diameter.

Norme de référence construction EN733 (DIN24255)
(*) Valeur se référant à la roue à ailettes avec le diamètre maximum.

Norma di riferimento costruttivo EN733 (DIN24255)
(*) Valore riferito alla girante con diametro massimo

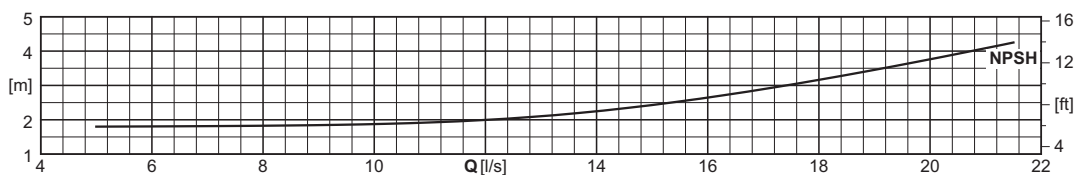
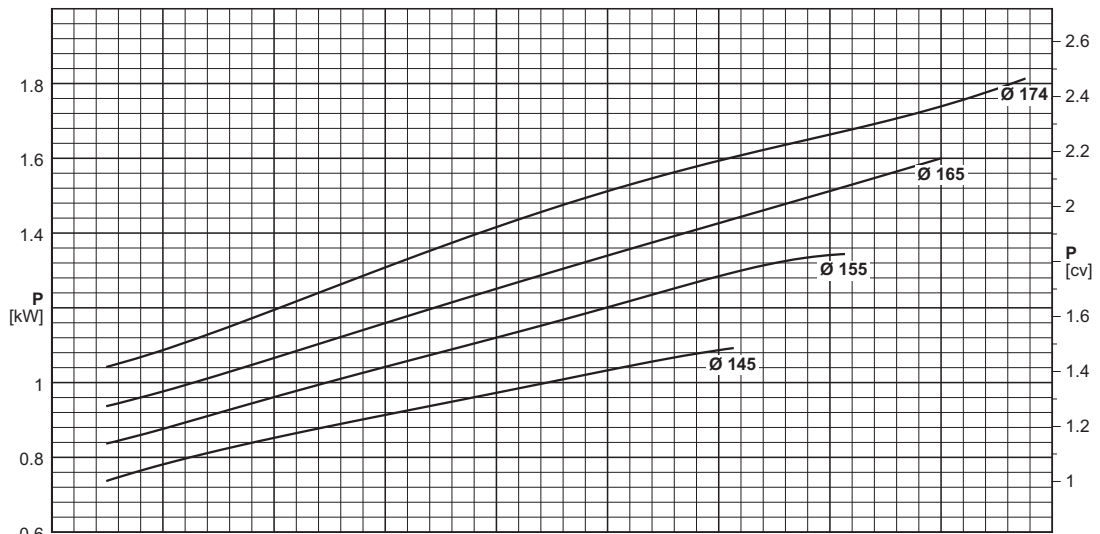
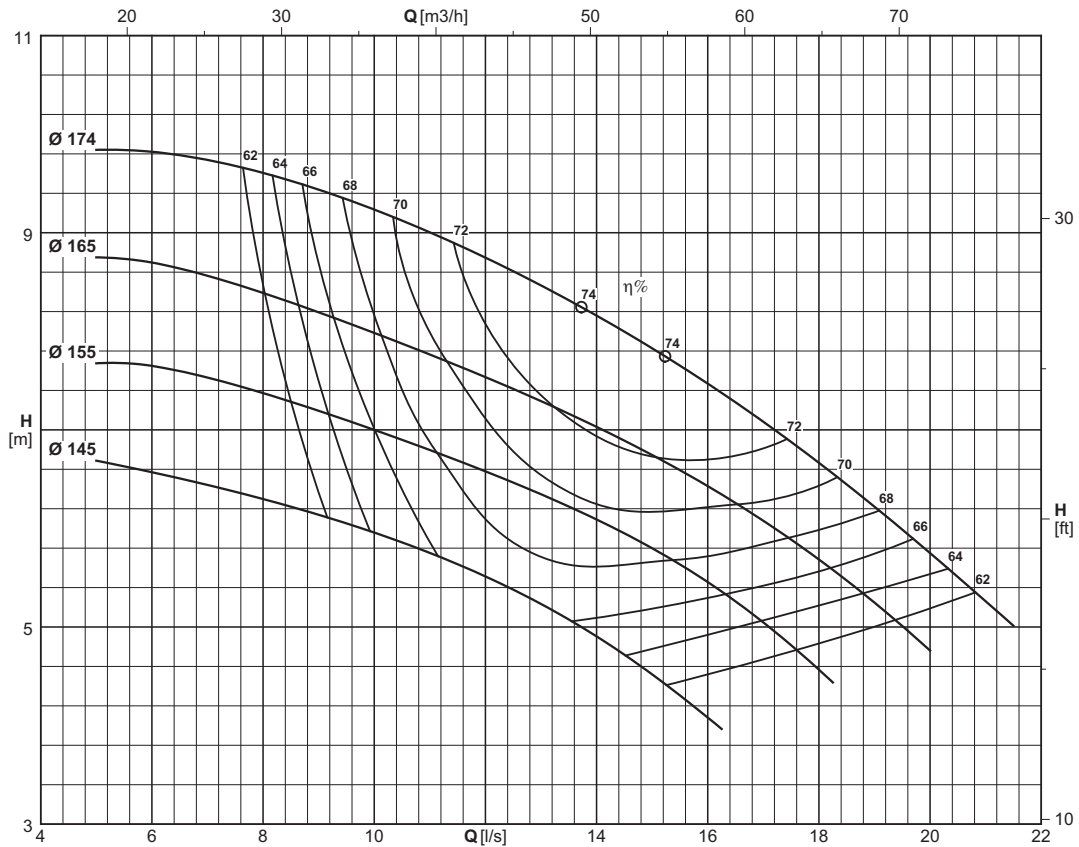

Type Type Tipo	Inlet maximum pressure (*) Pression maximale en aspiration (*) Pressione massima in aspirazione (*)	Dynamic momentum J Momentum dynamique J Momento dinamico J	
		With cast iron impellers Avec roues en fonte Con giranti in ghisa	With AISI 316 impellers Avec roues en AISI 316 Con giranti in AISI 316
		J=1/4PD²	
[bar]		[kgm²]	
NC65-160	8	0,01747	(F) 0,01913

Construction reference standard EN733 (DIN24255)
 (*) Value referred to the impeller with maximum diameter.

Norme de référence construction EN733 (DIN24255)
 (*) Valeur se référant à la roue à ailettes avec le diamètre maximum.

Norma di riferimento costruttivo EN733 (DIN24255)
 (*) Valore riferito alla girante con diametro massimo

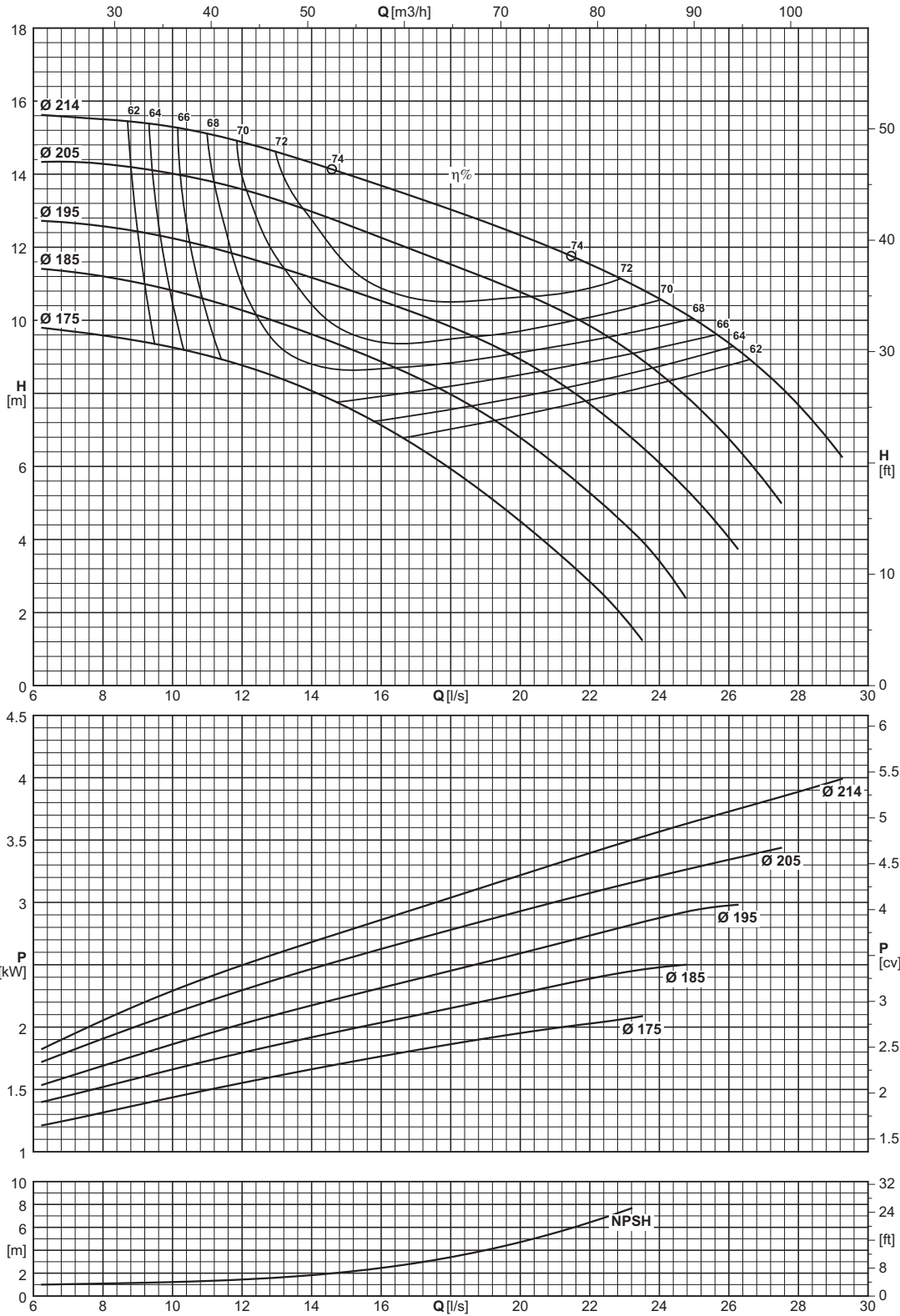

Type Type Tipo	Inlet maximum pressure (*) Pression maximale en aspiration (*) Pressione massima in aspirazione (*)	Dynamic momentum J Momentum dynamique J Momento dinamico J	
		With cast iron impellers Avec roues en fonte Con giranti in ghisa	With AISI 316 impellers Avec roues en AISI 316 Con giranti in AISI 316
		J = 1/4 PD ²	
	[bar]	[kgm ²]	[kgm ²]
NC65-200	7	0,02938	(F) 0,03217

Construction reference standard EN733 (DIN24255)
(*) Value referred to the impeller with maximum diameter.

Norme de référence construction EN733 (DIN24255)
(*) Valeur se référant à la roue à ailettes avec le diamètre maximum.

Norma di riferimento costruttivo EN733 (DIN24255)
(*) Valore riferito alla girante con diametro massimo

Operating data
 Caracteristiques de fonctionnement
 Caratteristiche di funzionamento

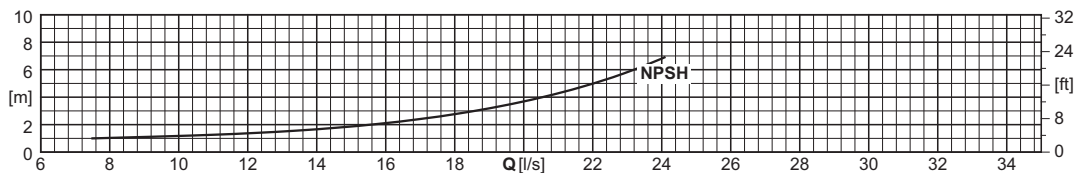
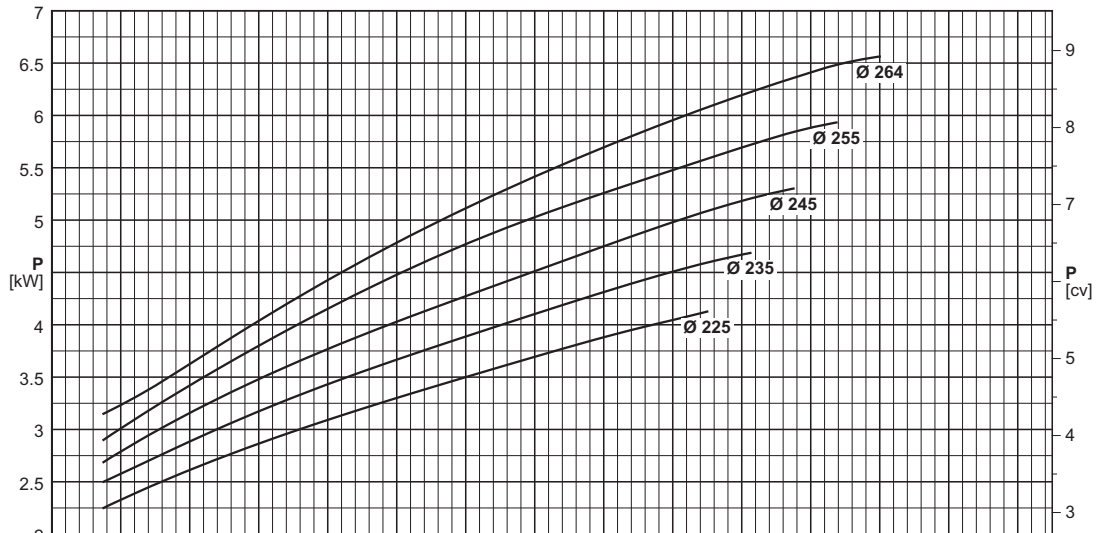
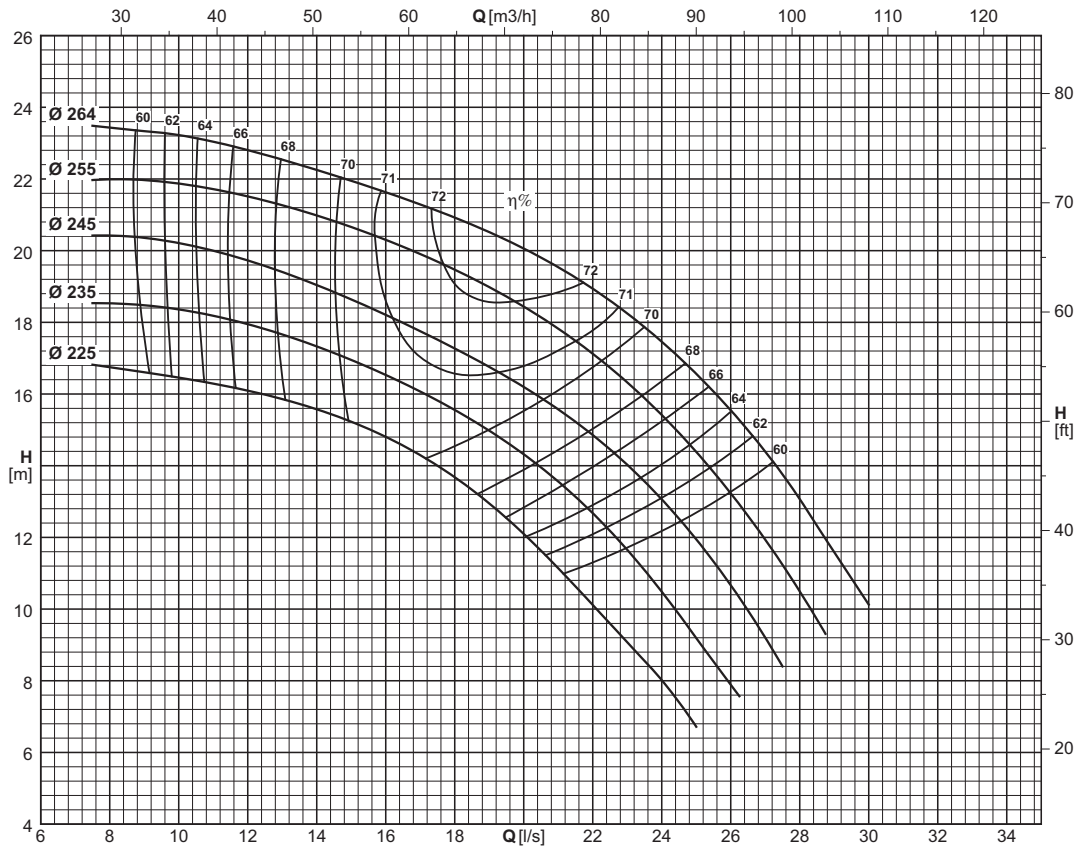

Type Type Tipo	Inlet maximum pressure (*) Pression maximale en aspiration (*) Pressione massima in aspirazione (*)	Dynamic momentum J Momentum dynamique J Momento dinamico J	
		With cast iron impellers Avec roues en fonte Con giranti in ghisa	With AISI 316 impellers Avec roues en AISI 316 Con giranti in AISI 316
		$J = \frac{1}{4}PD^2$	
	[bar]	[kgm ²]	
NC65-250	6	0,06090	(F) 0,06668

Construction reference standard EN733 (DIN24255)
 (*) Value referred to the impeller with maximum diameter.

Norme de référence construction EN733 (DIN24255)
 (*) Valeur se référant à la roue à ailettes avec le diamètre maximum.

Norma di riferimento costruttivo EN733 (DIN24255)
 (*) Valore riferito alla girante con diametro massimo

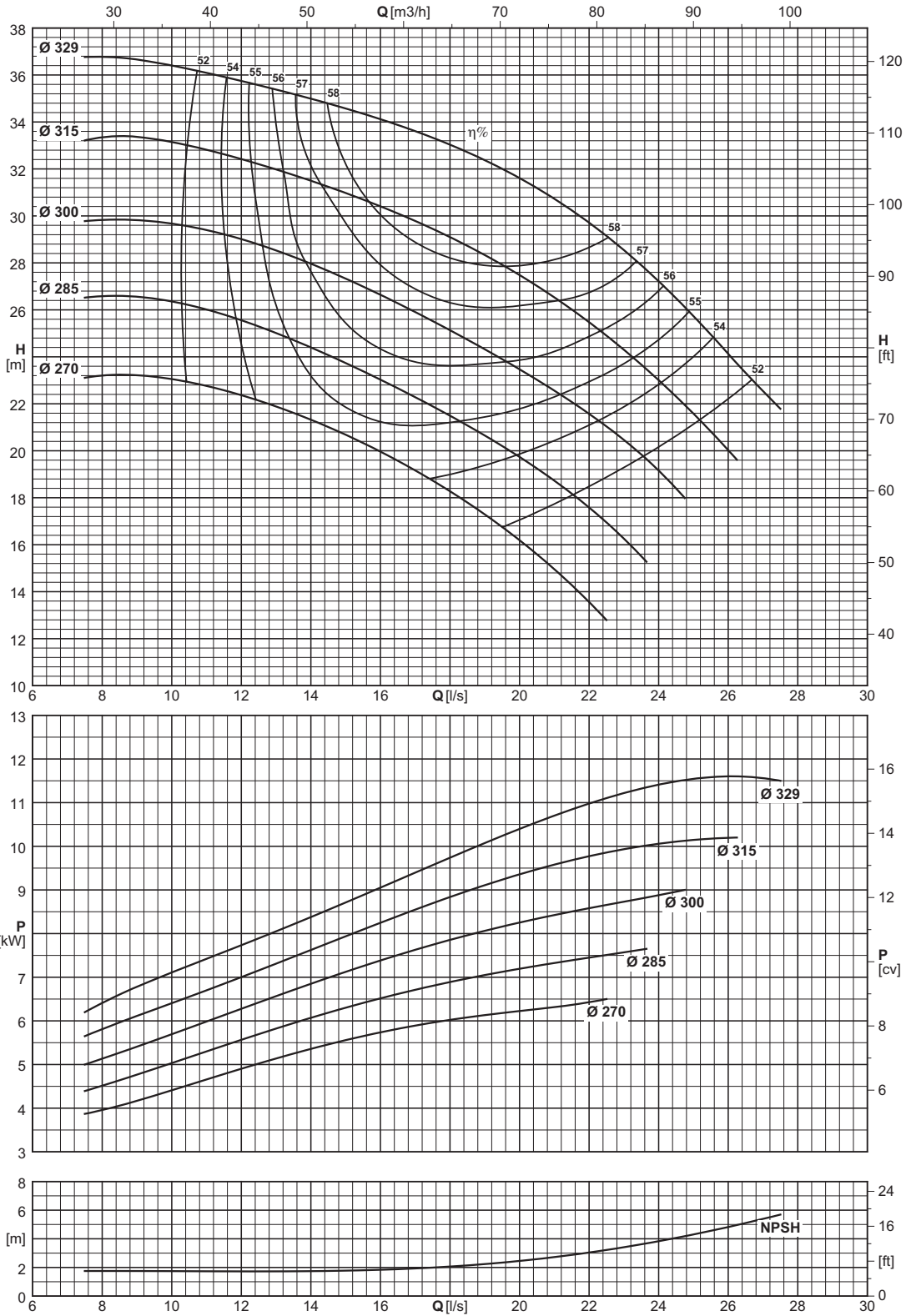

Type Type Tipo	Inlet maximum pressure (*) Pression maximale en aspiration (*) Pressione massima in aspirazione (*)	Dynamic momentum J Momentum dynamique J Momento dinamico J	
		With cast iron impellers Avec roues en fonte Con giranti in ghisa	With AISI 316 impellers Avec roues en AISI 316 Con giranti in AISI 316
		J=1/4PD²	
[bar]		[kgm²]	
NC65-315	5	0,20529	(F) 0,22480

Construction reference standard EN733 (DIN24255)
(*) Value referred to the impeller with maximum diameter.

Norme de référence construction EN733 (DIN24255)
(*) Valeur se référant à la roue à ailettes avec le diamètre maximum.

Norma di riferimento costruttivo EN733 (DIN24255)
(*) Valore riferito alla girante con diametro massimo

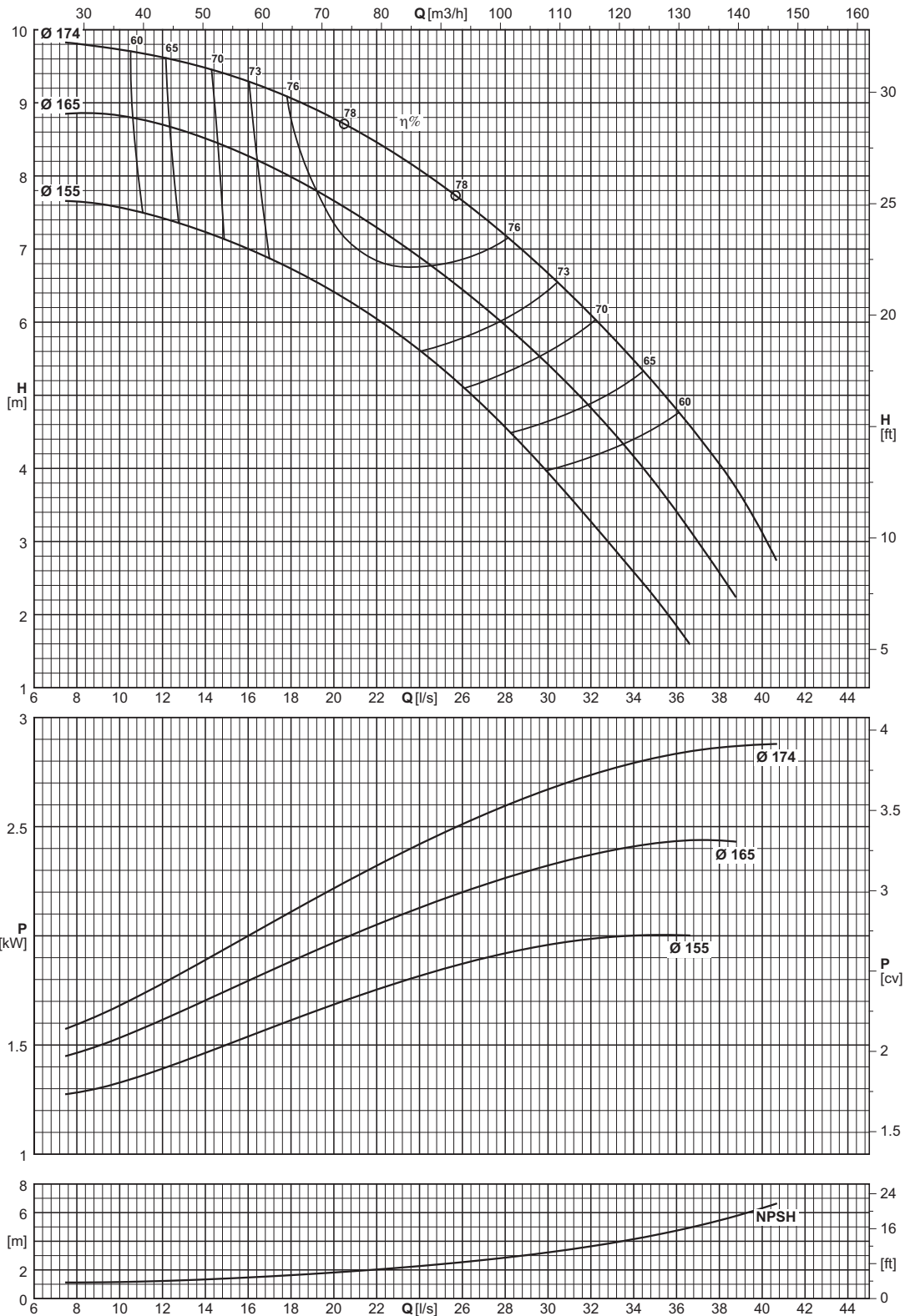

Type Type Tipo	Inlet maximum pressure (*) Pression maximale en aspiration (*) Pressione massima in aspirazione (*)	Dynamic momentum J Momentum dynamique J Momento dinamico J	
		With cast iron impellers Avec roues en fonte Con giranti in ghisa	With AISI 316 impellers Avec roues en AISI 316 Con giranti in AISI 316
		J=1/4PD²	
	[bar]	[kgm²]	[kgm²]
NC80-160	8	0,01982	(F) 0,02170

Construction reference standard EN733 (DIN24255)
 (*) Value referred to the impeller with maximum diameter.

Norme de référence construction EN733 (DIN24255)
 (*) Valeur se référant à la roue à ailettes avec le diamètre maximum.

Norma di riferimento costruttivo EN733 (DIN24255)
 (*) Valore riferito alla girante con diametro massimo

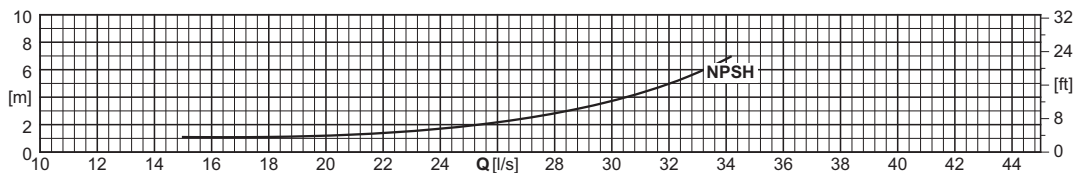
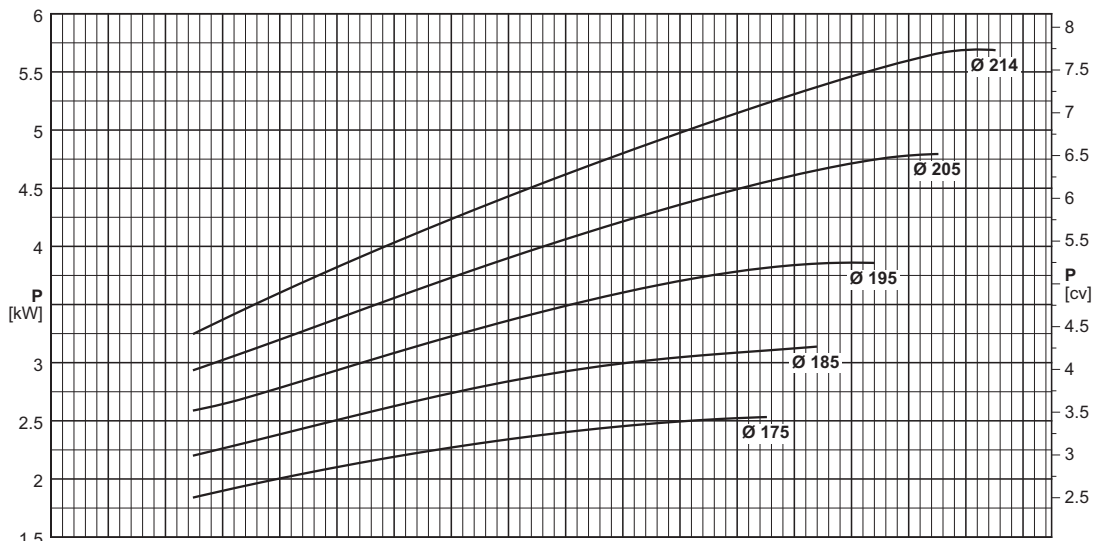
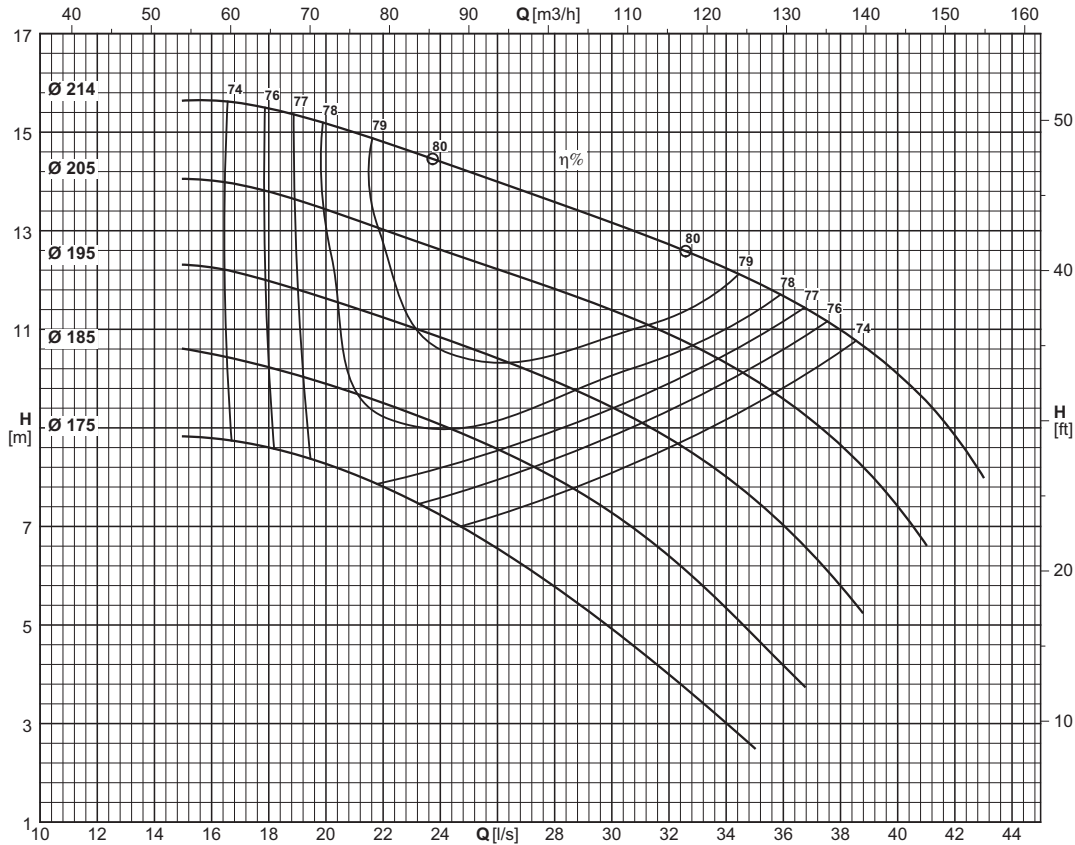

Type Type Tipo	Inlet maximum pressure (*) Pression maximale en aspiration (*) Pressione massima in aspirazione (*)	Dynamic momentum J Momentum dynamique J Momento dinamico J	
		With cast iron impellers Avec roues en fonte Con giranti in ghisa	With AISI 316 impellers Avec roues en AISI 316 Con giranti in AISI 316
		J=1/4PD ²	
	[bar]	[kgm ²]	[kgm ²]
NC80-200	7	0,04348	(F) 0,04761

Construction reference standard EN733 (DIN24255)
(*) Value referred to the impeller with maximum diameter.

Norme de référence construction EN733 (DIN24255)
(*) Valeur se référant à la roue à ailettes avec le diamètre maximum.

Norma di riferimento costruttivo EN733 (DIN24255)
(*) Valore riferito alla girante con diametro massimo

Operating data
 Caracteristiques de fonctionnement
 Caratteristiche di funzionamento

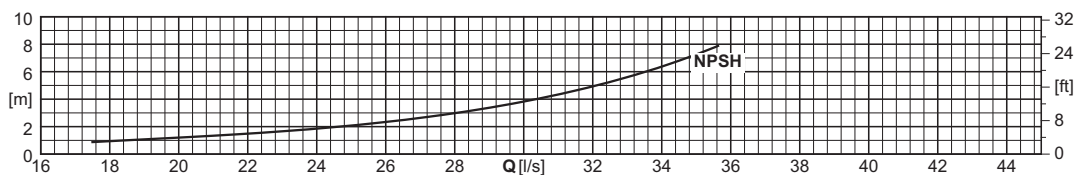
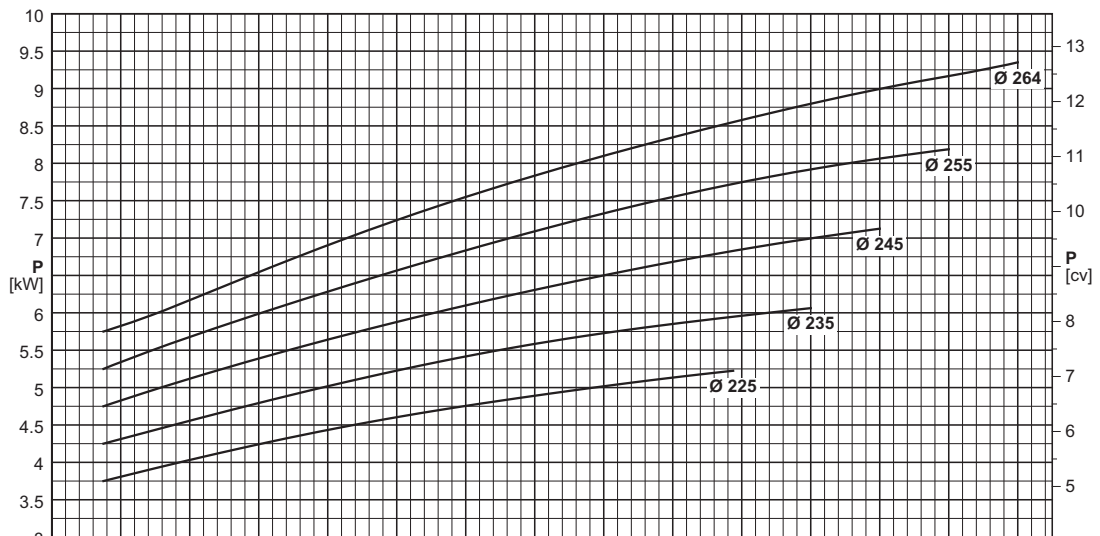
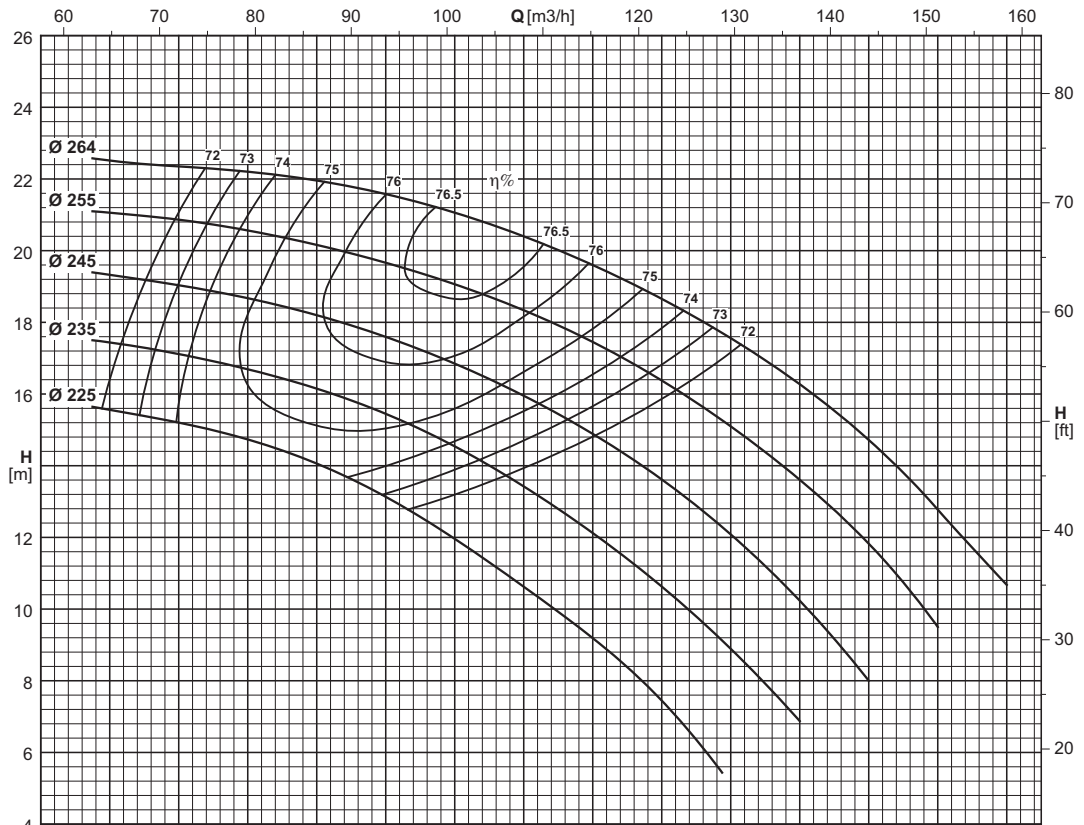

Type Type Tipo	Inlet maximum pressure (*) Pression maximale en aspiration (*) Pressione massima in aspirazione (*)	Dynamic momentum J Momentum dynamique J Momento dinamico J	
		With cast iron impellers Avec roues en fonte Con giranti in ghisa	With AISI 316 impellers Avec roues en AISI 316 Con giranti in AISI 316
		$J = \frac{1}{4}PD^2$	
	[bar]	[kgm ²]	
NC80-250	6	0,07294	(F) 0,07987

Construction reference standard EN733 (DIN24255)
 (*) Value referred to the impeller with maximum diameter.

Norme de référence construction EN733 (DIN24255)
 (*) Valeur se référant à la roue à ailettes avec le diamètre maximum.

Norma di riferimento costruttivo EN733 (DIN24255)
 (*) Valore riferito alla girante con diametro massimo

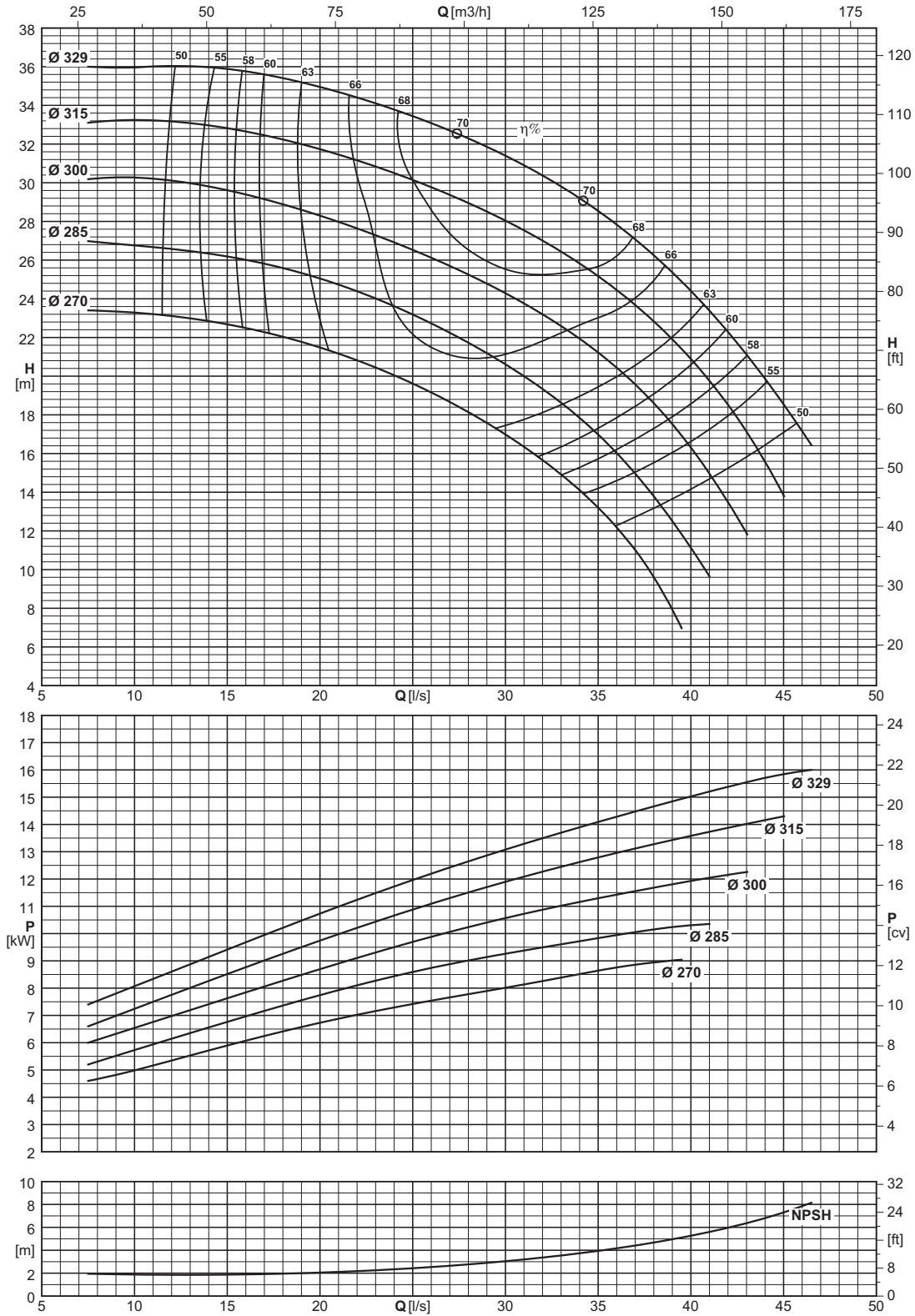

Type Type Tipo	Inlet maximum pressure (*) Pression maximale en aspiration (*) Pressione massima in aspirazione (*)	Dinamic momentum J Momentum dynamique J Momento dinamico J	
		With cast iron impellers Avec roues en fonte Con giranti in ghisa	With AISI 316 impellers Avec roues en AISI 316 Con giranti in AISI 316
		J=1/2PD²	
	[bar]	[kgm²]	[kgm²]
NC80-315	5	0,23170	(F) 0,25371

Construction reference standard EN733 (DIN24255)
(*) Value referred to the impeller with maximum diameter.

Norme de référence construction EN733 (DIN24255)
(*) Valeur se référant à la roue à ailettes avec le diamètre maximum.

Norma di riferimento costruttivo EN733 (DIN24255)
(*) Valore riferito alla girante con diametro massimo

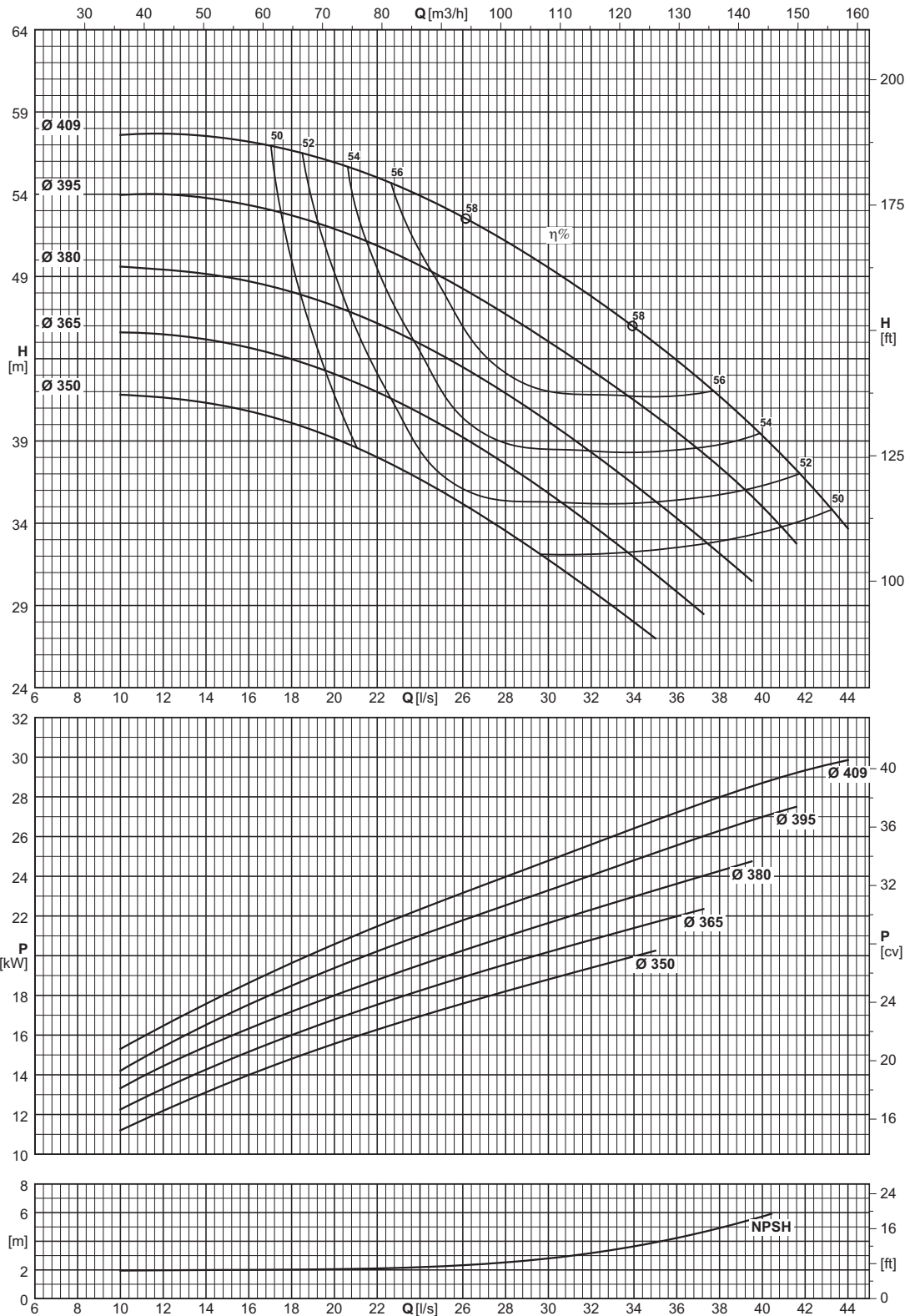

Type Type Tipo	Inlet maximum pressure (*) Pression maximale en aspiration (*) Pressione massima in aspirazione (*)	Dinamic momentum J Momentum dynamique J Momento dinamico J	
		With cast iron impellers Avec roues en fonte Con giranti in ghisa	With AISI 316 impellers Avec roues en AISI 316 Con giranti in AISI 316
		J=¼PD²	
	[bar]	[kgm²]	
NC80-400	3	0,55000	(F) 0,60225

(*) Value referred to the impeller with maximum diameter.

(*) Valeur se référant à la roue à ailettes avec le diamètre maximum.

(*) Valore riferito alla girante con diametro massimo

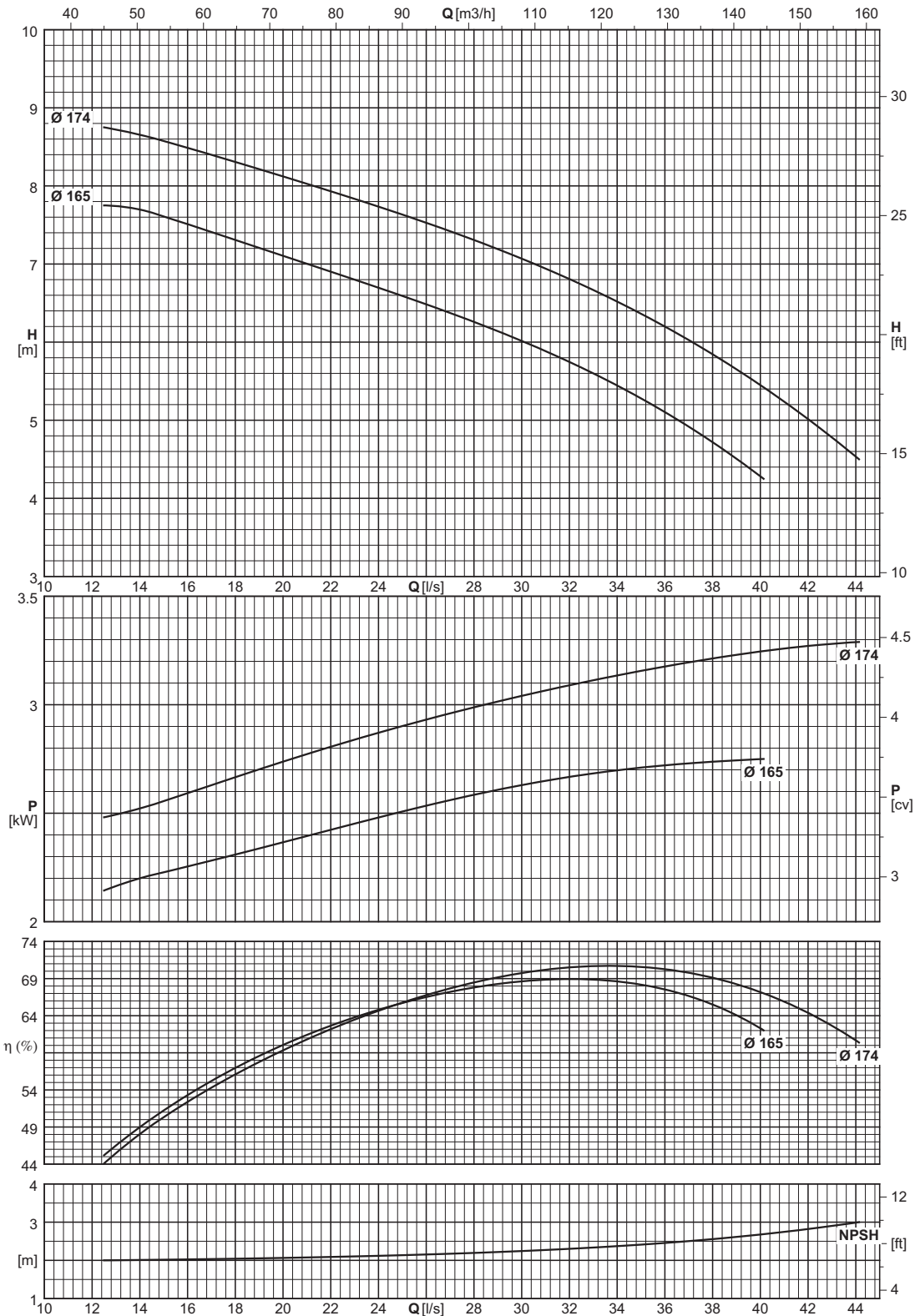

Type Type Tipo	Inlet maximum pressure (*) Pression maximale en aspiration (*) Pressione massima in aspirazione (*)	Dynamic momentum J Momentum dynamique J Momento dinamico J	
		With cast iron impellers Avec roues en fonte Con giranti in ghisa	With AISI 316 impellers Avec roues en AISI 316 Con giranti in AISI 316
		J=1/4PD ²	
	[bar]	[kgm ²]	
NC100-160	8	0,03800	(F) 0,04161

(*) Value referred to the impeller with maximum diameter. (*) Valeur se référant à la roue à ailettes avec le diamètre maximum. (*) Valore riferito alla girante con diametro massimo

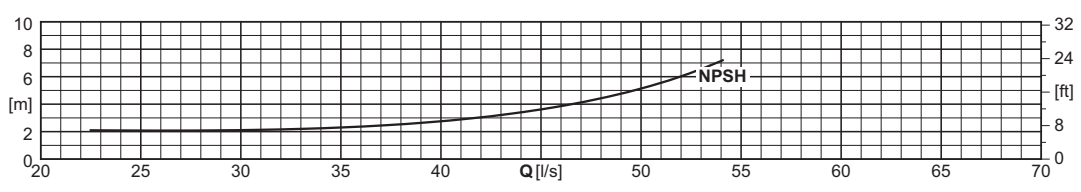
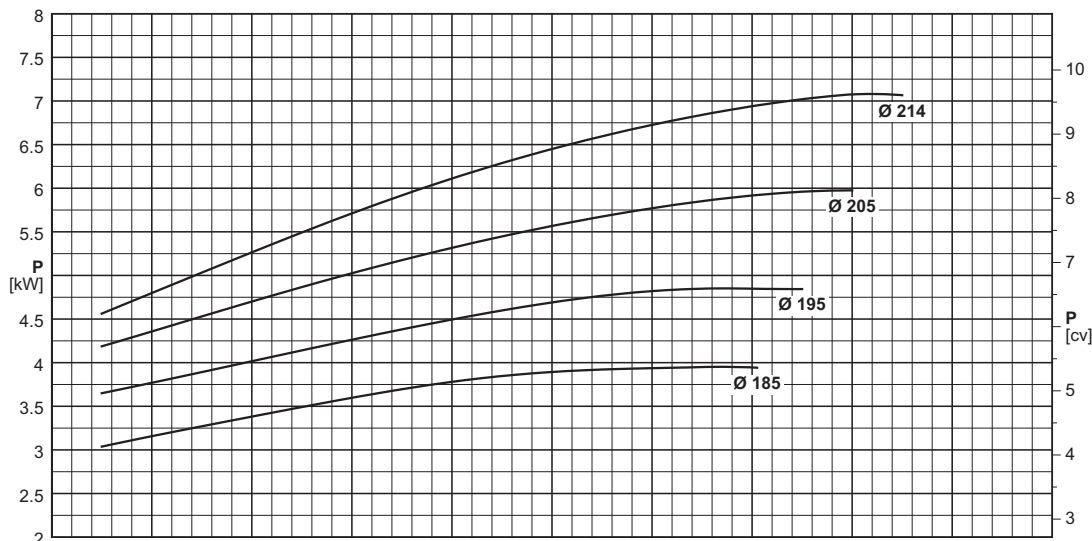
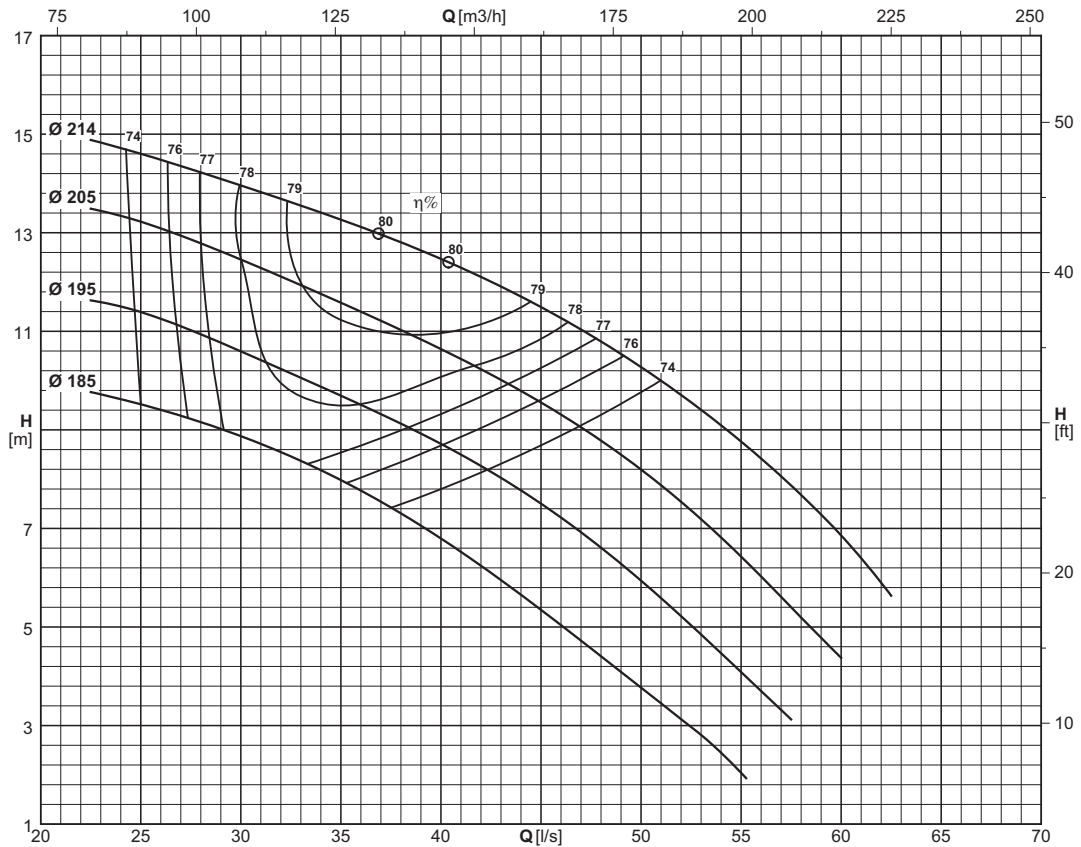

Type Type Tipo	Inlet maximum pressure (*) Pression maximale en aspiration (*) Pressione massima in aspirazione (*)	Dynamic momentum J Momentum dynamique J Momento dinamico J	
		With cast iron impellers Avec roues en fonte Con giranti in ghisa	With AISI 316 impellers Avec roues en AISI 316 Con giranti in AISI 316
		$J = \frac{1}{4}PD^2$	
	[bar]	[kgm ²]	
NC100-200	7	0,04830	(F) 0,05289

Construction reference standard EN733 (DIN24255)
(*) Value referred to the impeller with maximum diameter.

Norme de référence construction EN733 (DIN24255)
(*) Valeur se référant à la roue à ailettes avec le diamètre maximum.

Norma di riferimento costruttivo EN733 (DIN24255)
(*) Valore riferito alla girante con diametro massimo

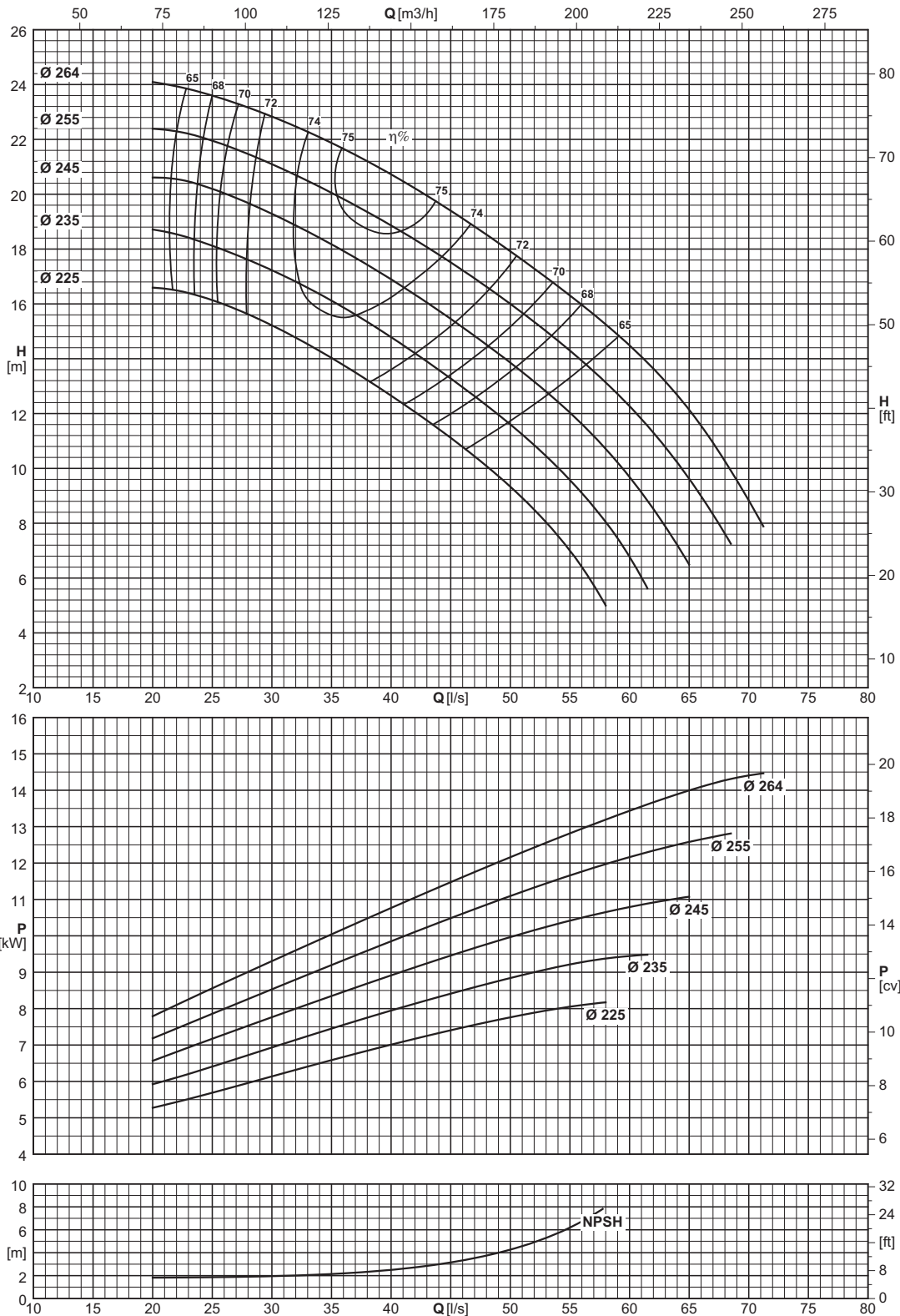

Type Type Tipo	Inlet maximum pressure (*) Pression maximale en aspiration (*) Pressione massima in aspirazione (*)	Dynamic momentum J Momentum dynamique J Momento dinamico J	
		With cast iron impellers Avec roues en fonte Con giranti in ghisa	With AISI 316 impellers Avec roues en AISI 316 Con giranti in AISI 316
	[bar]	J = 1/4 PD ² [kgm ²]	
NC100-250	6	0,08165	(F) 0,08941

Construction reference standard EN733 (DIN24255)
(*) Value referred to the impeller with maximum diameter.

Norme de référence construction EN733 (DIN24255)
(*) Valeur se référant à la roue à ailettes avec le diamètre maximum.

Norma di riferimento costruttivo EN733 (DIN24255)
(*) Valore riferito alla girante con diametro massimo

Operating data
 Caracteristiques de fonctionnement
 Caratteristiche di funzionamento

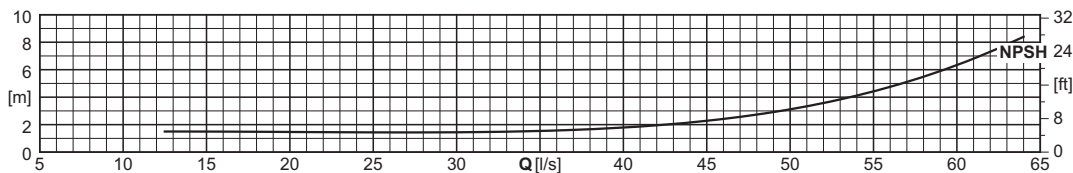
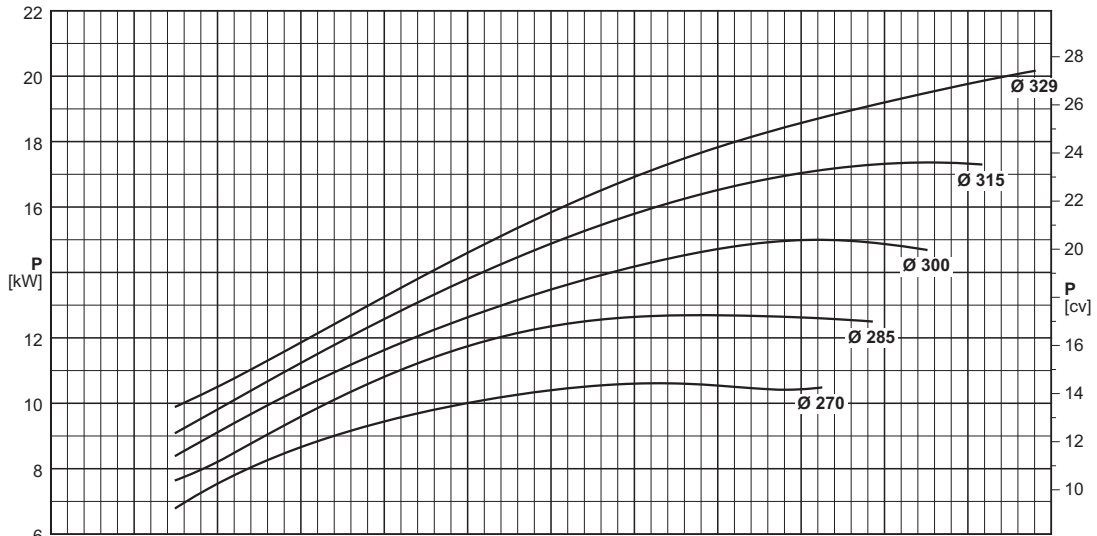
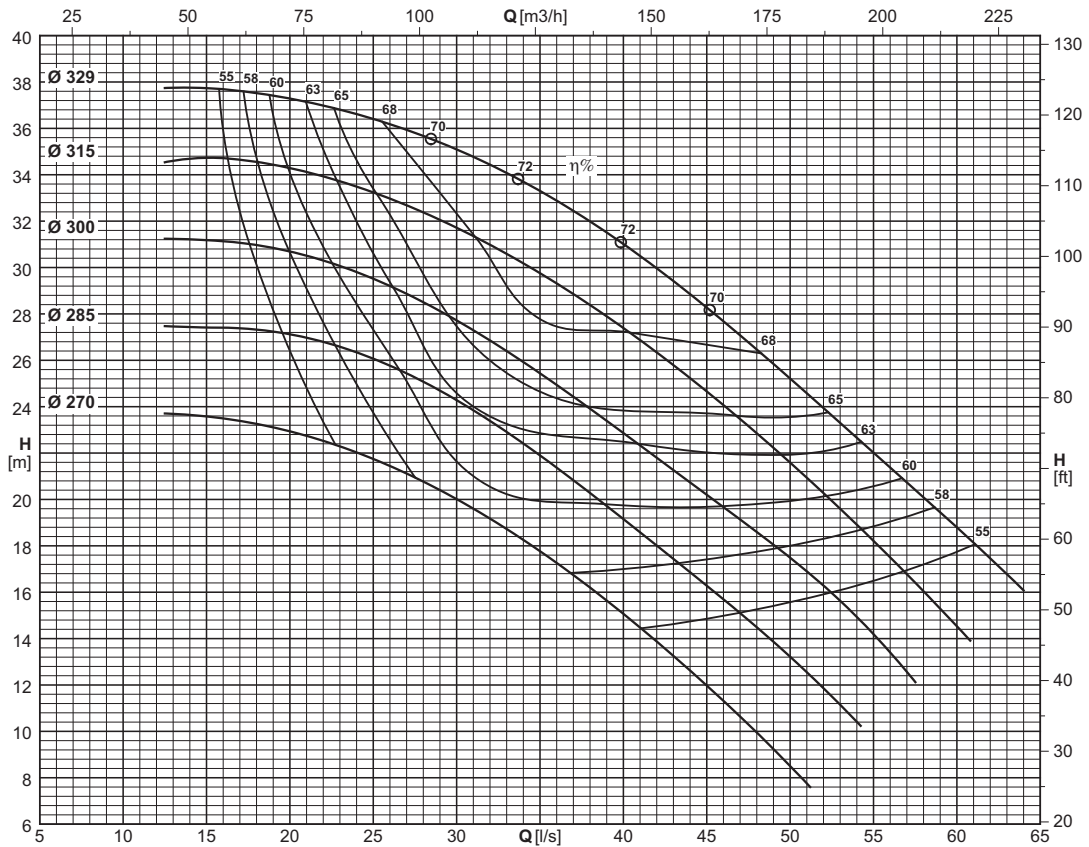

Type Type Tipo	Inlet maximum pressure (*) Pression maximale en aspiration (*) Pressione massima in aspirazione (*)	Dynamic momentum J Momentum dynamique J Momento dinamico J	
		With cast iron impellers Avec roues en fonte Con giranti in ghisa	With AISI 316 impellers Avec roues en AISI 316 Con giranti in AISI 316
		$J = \frac{1}{4}PD^2$	
	[bar]	[kgm ²]	
NC100-315	5	0,24145	(F) 0,26439

Construction reference standard EN733 (DIN24255)
 (*) Value referred to the impeller with maximum diameter.

Norme de référence construction EN733 (DIN24255)
 (*) Valeur se référant à la roue à ailettes avec le diamètre maximum.

Norma di riferimento costruttivo EN733 (DIN24255)
 (*) Valore riferito alla girante con diametro massimo

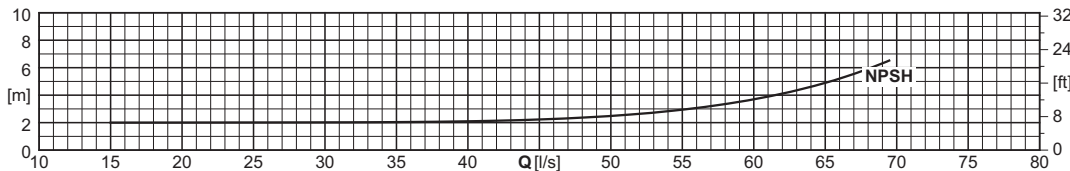
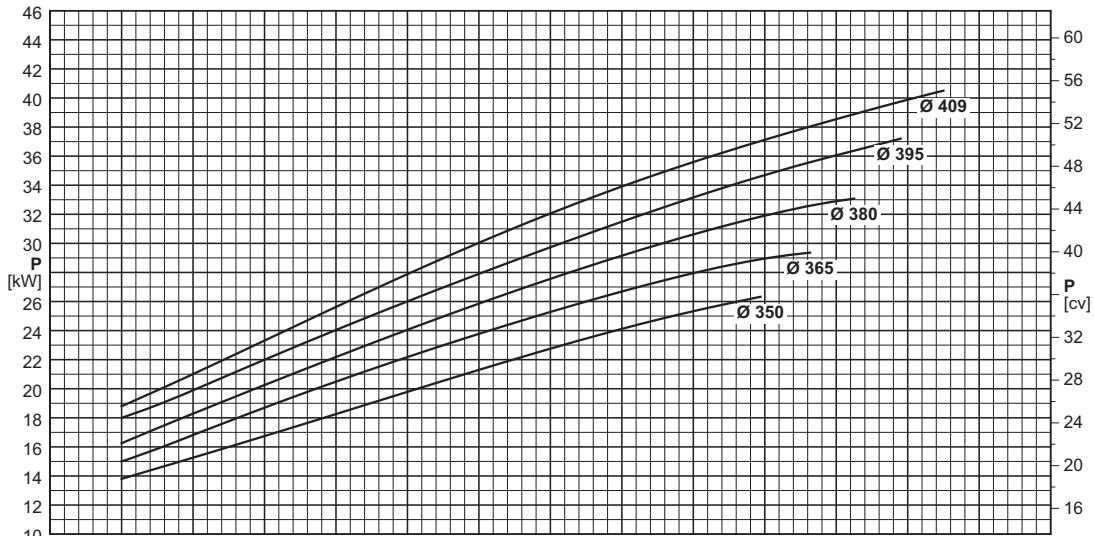
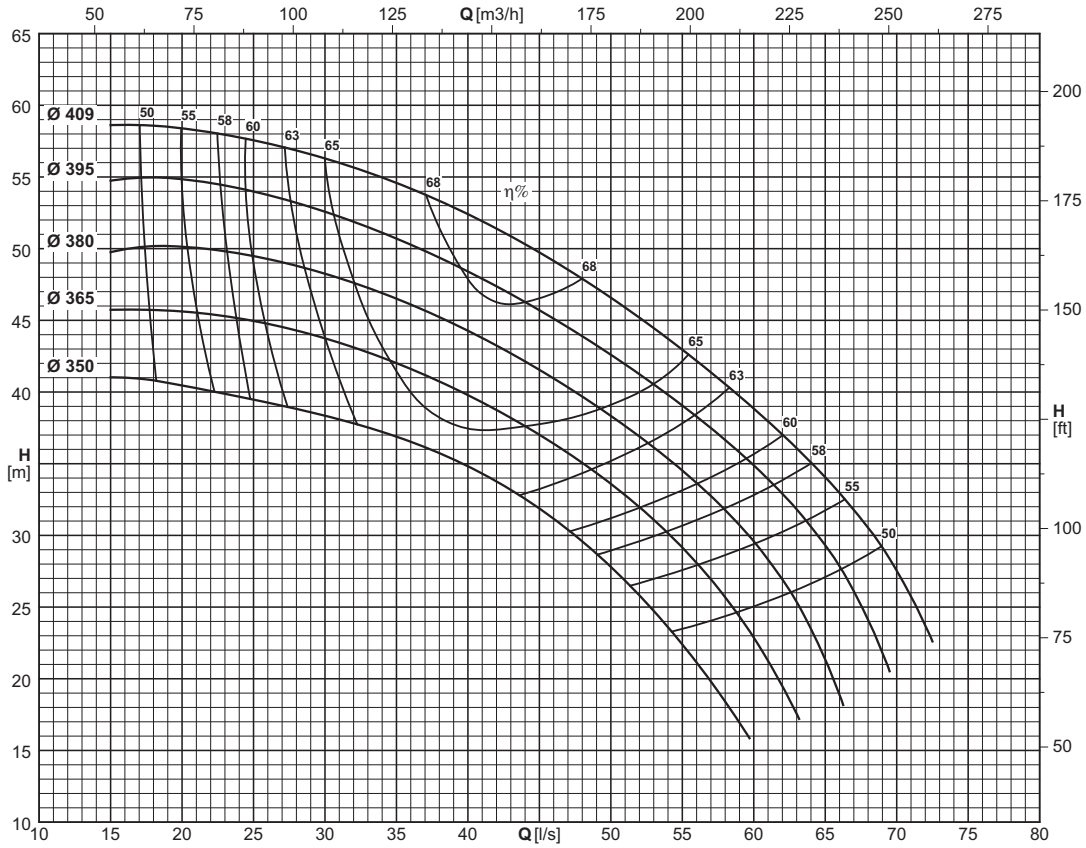

Type Type Tipo	Inlet maximum pressure (*) Pression maximale en aspiration (*) Pressione massima in aspirazione (*)	Dynamic momentum J Momentum dynamique J Momento dinamico J	
		With cast iron impellers Avec roues en fonte Con giranti in ghisa	With AISI 316 impellers Avec roues en AISI 316 Con giranti in AISI 316
		J = 1/4 PD ²	
	[bar]	[kgm ²]	
NC100-400	3	0,71326	(F) 0,78102

Construction reference standard EN733 (DIN24255)
(*) Value referred to the impeller with maximum diameter.

Norme de référence construction EN733 (DIN24255)
(*) Valeur se référant à la roue à ailettes avec le diamètre maximum.

Norma di riferimento costruttivo EN733 (DIN24255)
(*) Valore riferito alla girante con diametro massimo

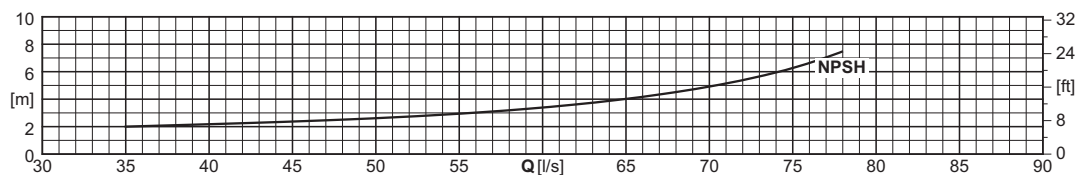
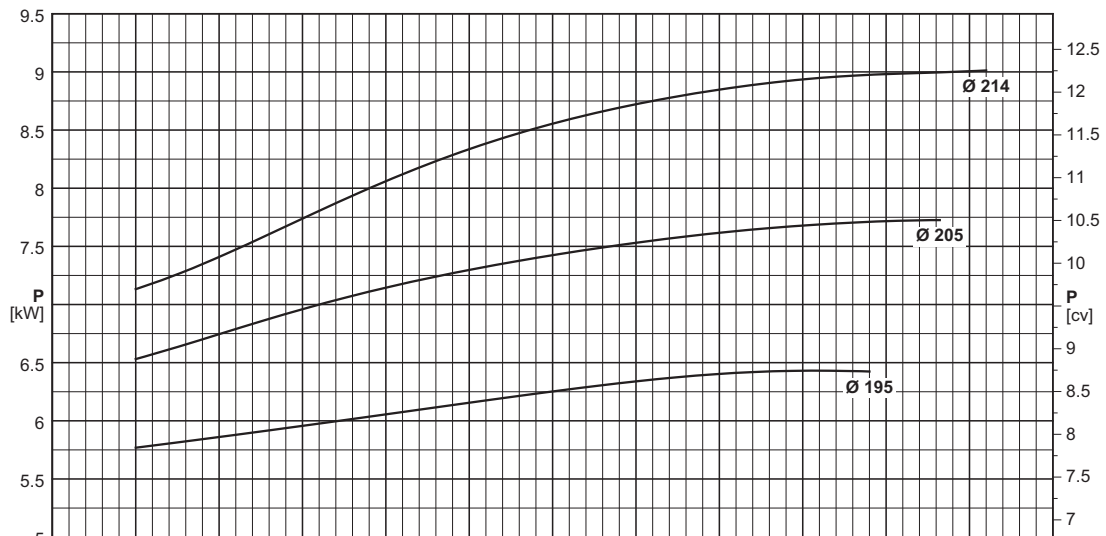
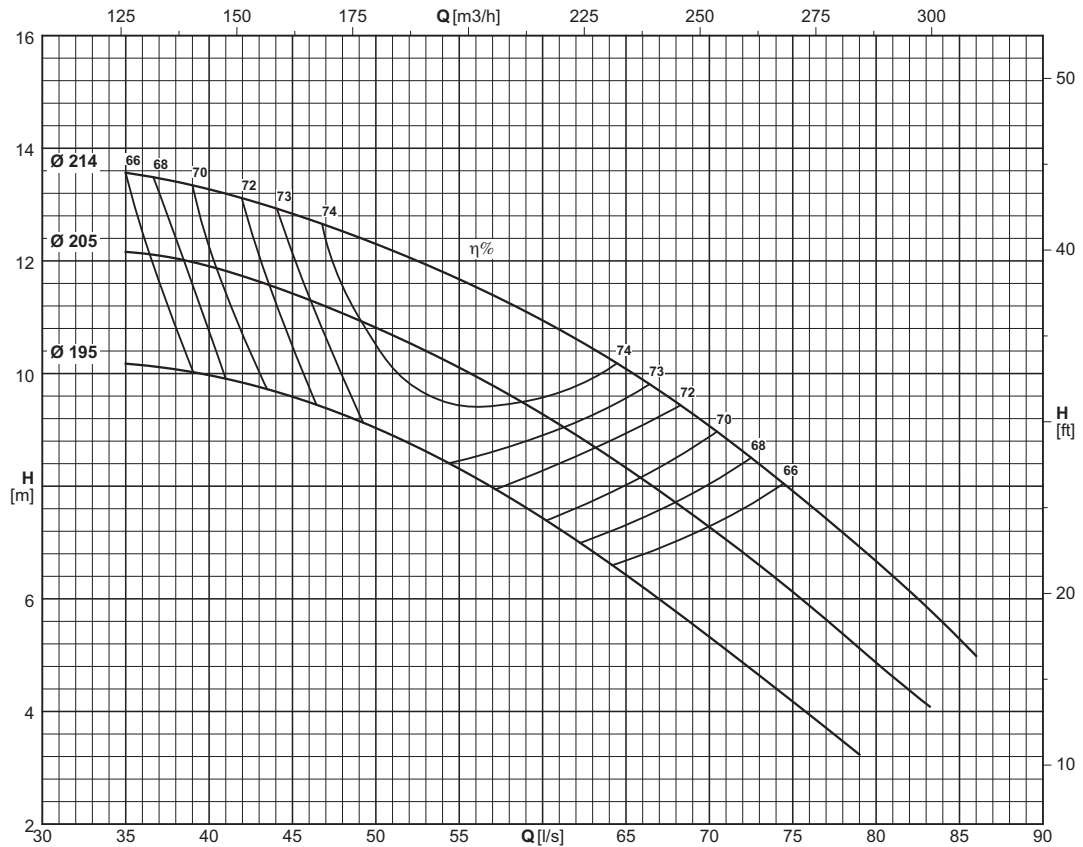

Type Type Tipo	Inlet maximum pressure (*) Pression maximale en aspiration (*) Pressione massima in aspirazione (*)	Dynamic momentum J Momentum dynamique J Momento dinamico J	
		With cast iron impellers Avec roues en fonte Con giranti in ghisa	With AISI 316 impellers Avec roues en AISI 316 Con giranti in AISI 316
		$J = \frac{1}{4}PD^2$	
	[bar]	[kgm ²]	
NC125-200	7	0,06000	(F) 0,06570

(*) Value referred to the impeller with maximum diameter.

(*) Valeur se référant à la roue à ailettes avec le diamètre maximum.

(*) Valore riferito alla girante con diametro massimo

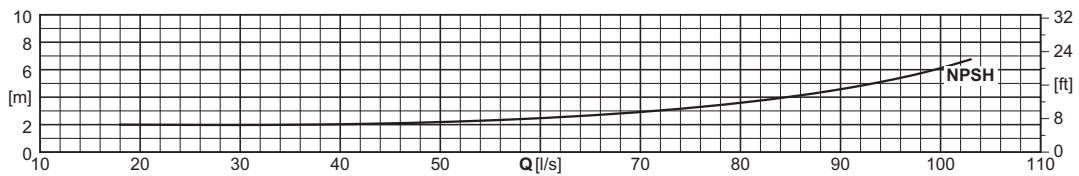
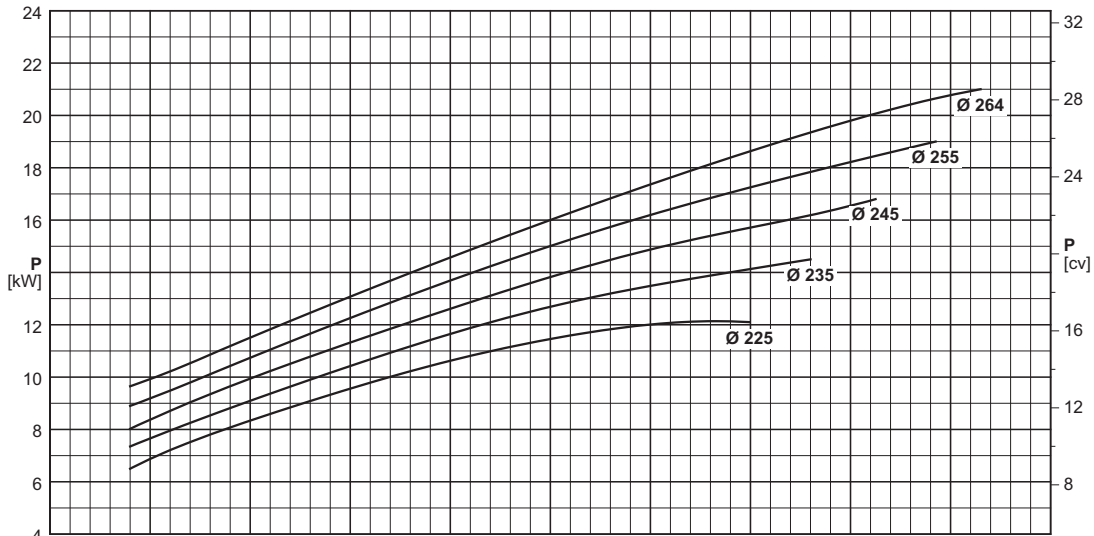
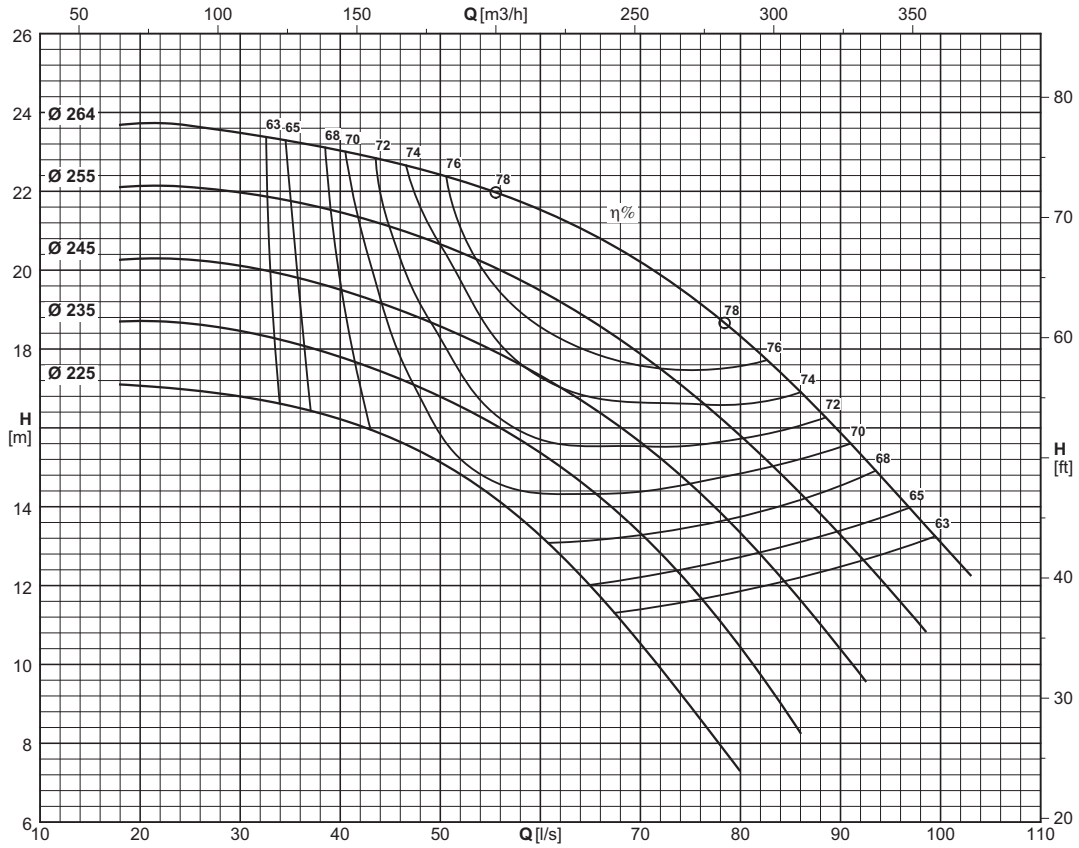

Type Type Tipo	Inlet maximum pressure (*) Pression maximale en aspiration (*) Pressione massima in aspirazione (*)	Dynamic momentum J Momentum dynamique J Momento dinamico J	
		With cast iron impellers Avec roues en fonte Con giranti in ghisa	With AISI 316 impellers Avec roues en AISI 316 Con giranti in AISI 316
		J=1/4PD²	
[bar]		[kgm²]	
NC125-250	6	0,08032	(F) 0,08795

Construction reference standard EN733 (DIN24255)
(*) Value referred to the impeller with maximum diameter.

Norme de référence construction EN733 (DIN24255)
(*) Valeur se référant à la roue à ailettes avec le diamètre maximum.

Norma di riferimento costruttivo EN733 (DIN24255)
(*) Valore riferito alla girante con diametro massimo

Operating data
 Caracteristiques de fonctionnement
 Caratteristiche di funzionamento

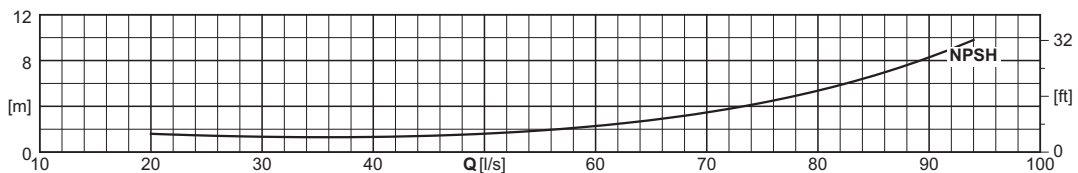
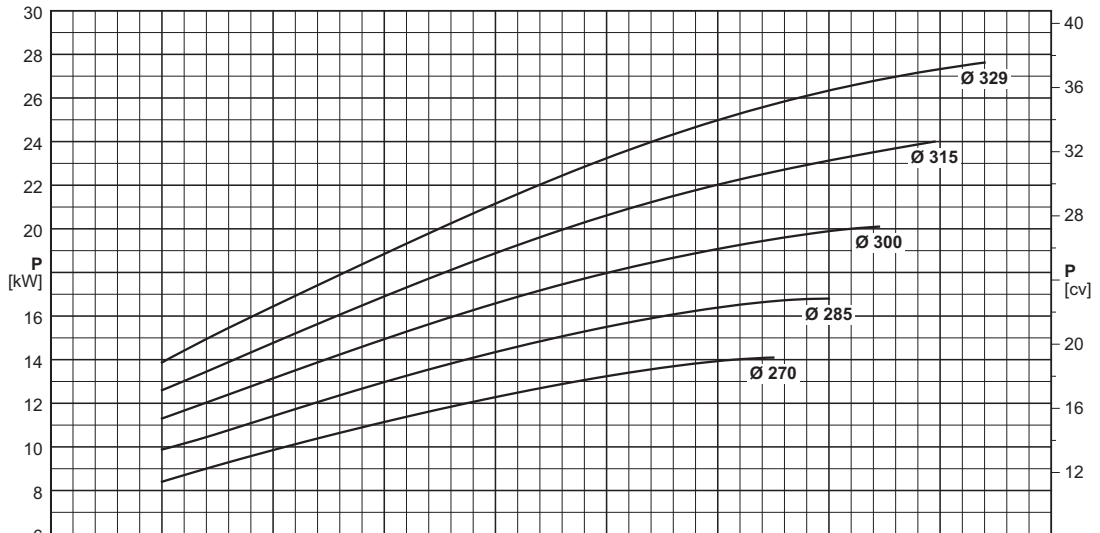
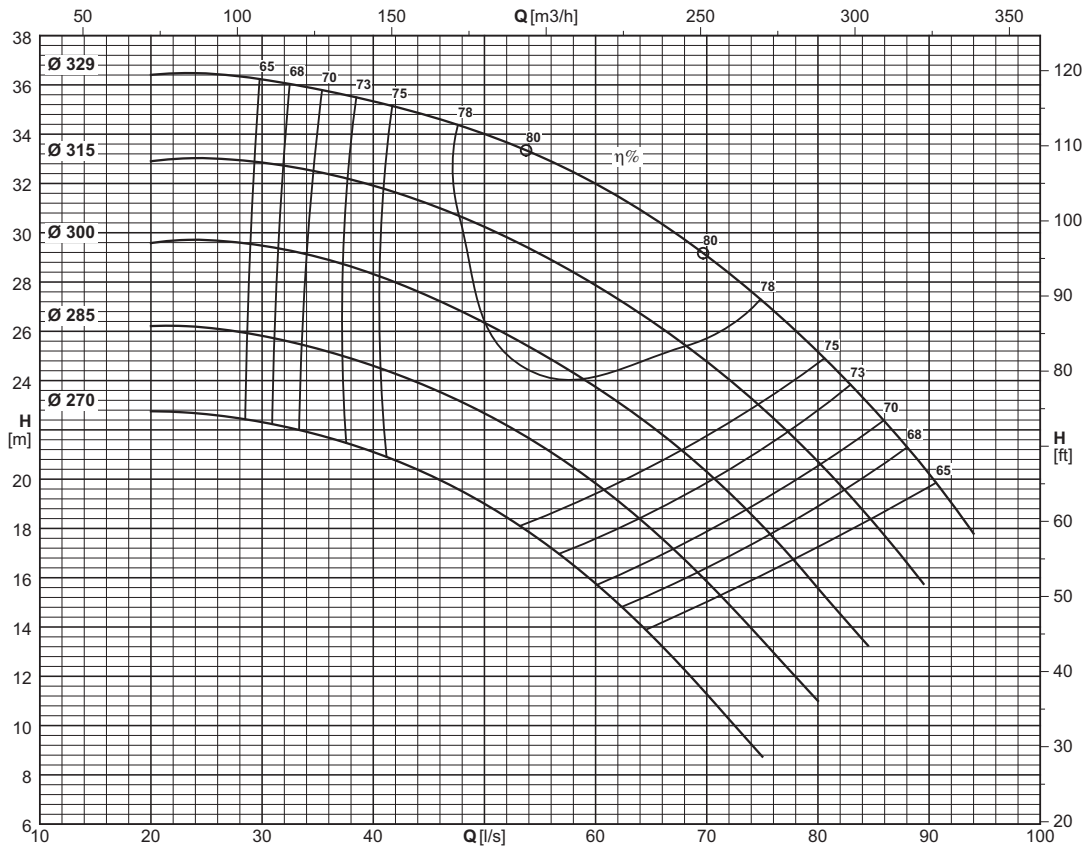

Type Type Tipo	Inlet maximum pressure (*) Pression maximale en aspiration (*) Pressione massima in aspirazione (*)	Dynamic momentum J Momentum dynamique J Momento dinamico J	
		With cast iron impellers Avec roues en fonte Con giranti in ghisa	With AISI 316 impellers Avec roues en AISI 316 Con giranti in AISI 316
		J=1/4PD ²	
	[bar]	[kgm ²]	[kgm ²]
NC125-315	5	0,17966	(F) 0,19672

Construction reference standard EN733 (DIN24255)
 (*) Value referred to the impeller with maximum diameter.

Norme de référence construction EN733 (DIN24255)
 (*) Valeur se référant à la roue à ailettes avec le diamètre maximum.

Norma di riferimento costruttivo EN733 (DIN24255)
 (*) Valore riferito alla girante con diametro massimo

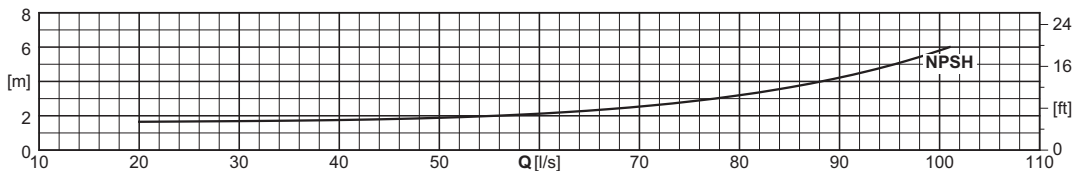
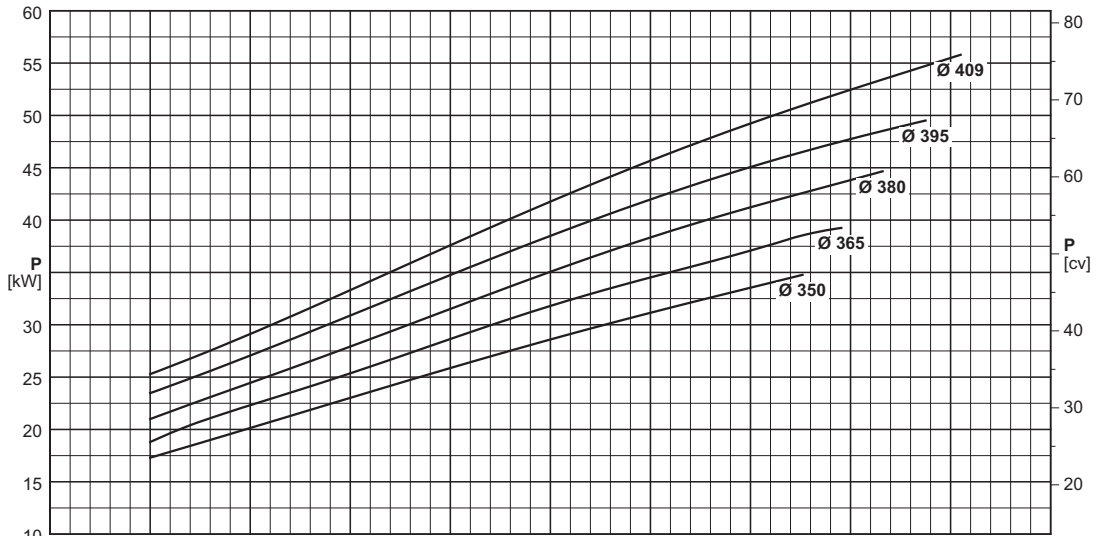
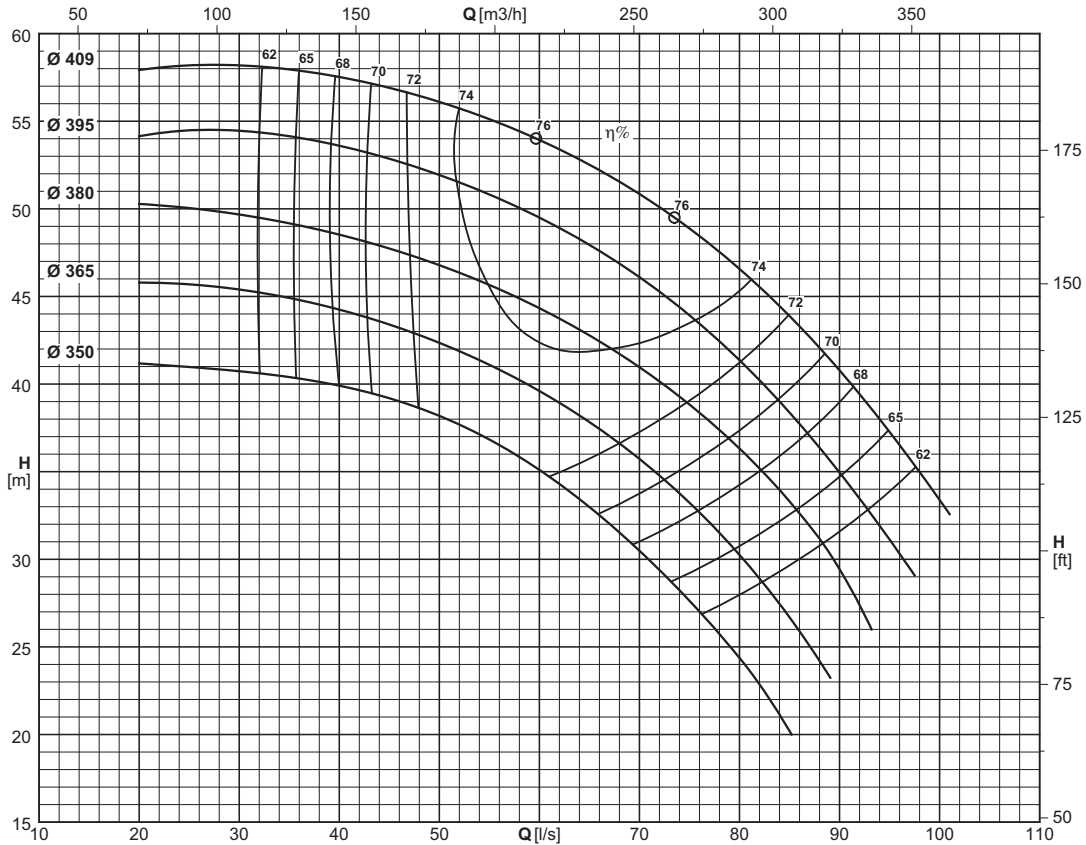

Type Type Tipo	Inlet maximum pressure (*) Pression maximale en aspiration (*) Pressione massima in aspirazione (*)	Dynamic momentum J Momentum dynamique J Momento dinamico J	
		With cast iron impellers Avec roues en fonte Con giranti in ghisa	With AISI 316 impellers Avec roues en AISI 316 Con giranti in AISI 316
		J = 1/4 PD ⁵	
	[bar]	[kgm ²]	[kgm ²]
NC125-400	3	0,78268	(F) 0,85703

Construction reference standard EN733 (DIN24255)
 (*) Value referred to the impeller with maximum diameter.

Norme de référence construction EN733 (DIN24255)
 (*) Valeur se référant à la roue à ailettes avec le diamètre maximum.

Norma di riferimento costruttivo EN733 (DIN24255)
 (*) Valore riferito alla girante con diametro massimo

Operating data
 Caracteristiques de fonctionnement
 Caratteristiche di funzionamento

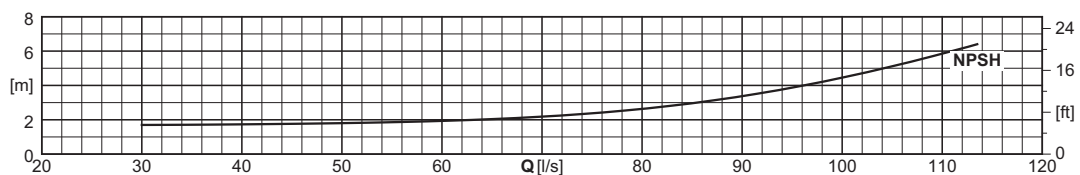
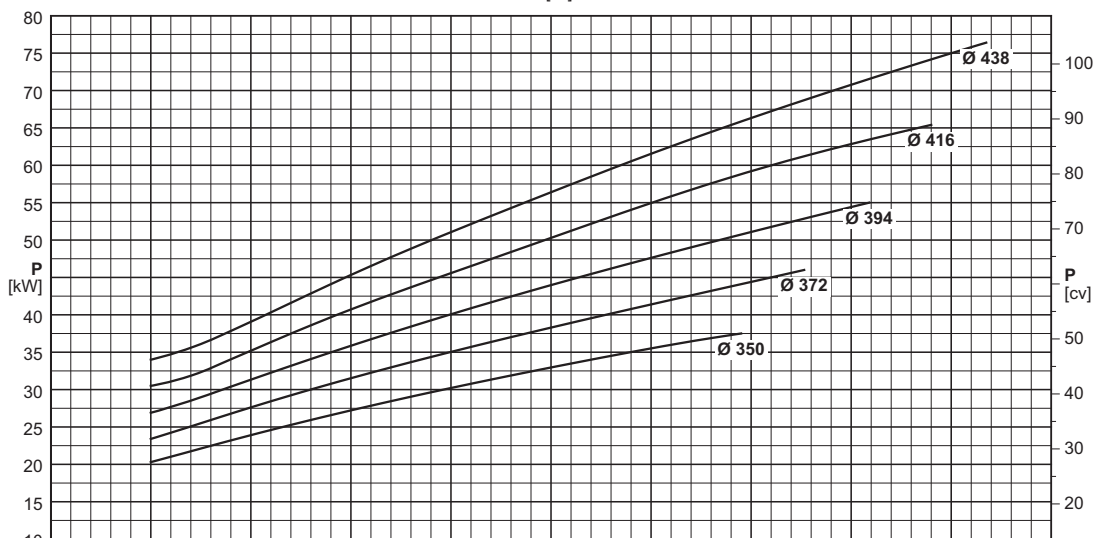
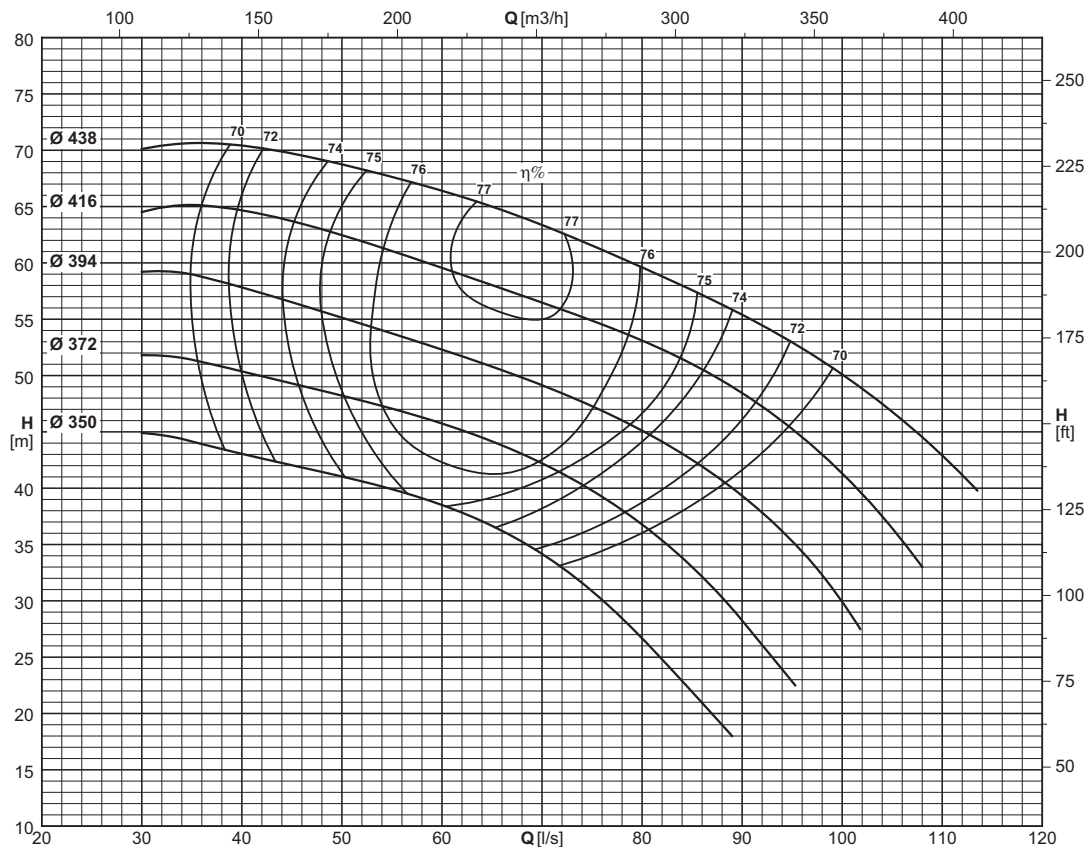

Type Type Tipo	Inlet maximum pressure (*) Pression maximale en aspiration (*) Pressione massima in aspirazione (*)	Dynamic momentum J Momentum dynamique J Momento dinamico J	
		With cast iron impellers Avec roues en fonte Con giranti in ghisa	With AISI 316 impellers Avec roues en AISI 316 Con giranti in AISI 316
		$J = \frac{1}{4}PD^2$	
		[bar]	[kgm ²]
NCH125-400	2.5	-	(F) -

(*) Value referred to the impeller with maximum diameter.

(*) Valeur se référant à la roue à ailettes avec le diamètre maximum.

(*) Valore riferito alla girante con diametro massimo

NCH 125-500

1450 n [min⁻¹]



Operating data
Caracteristiques de fonctionnement
Caratteristiche di funzionamento

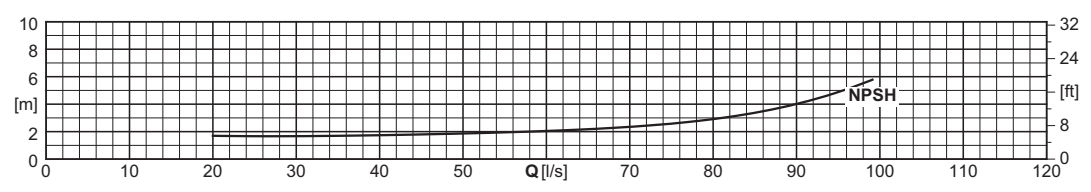
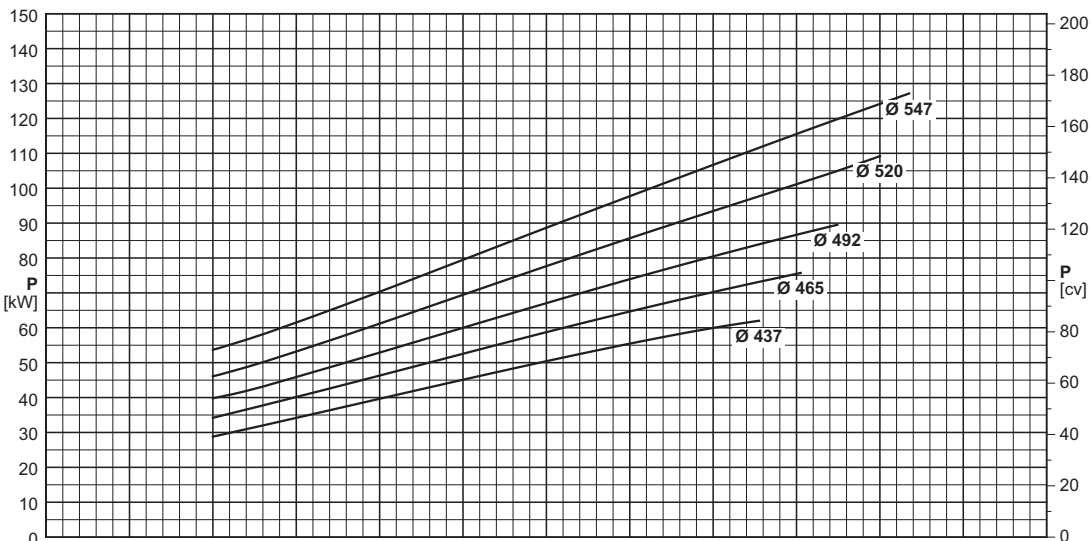
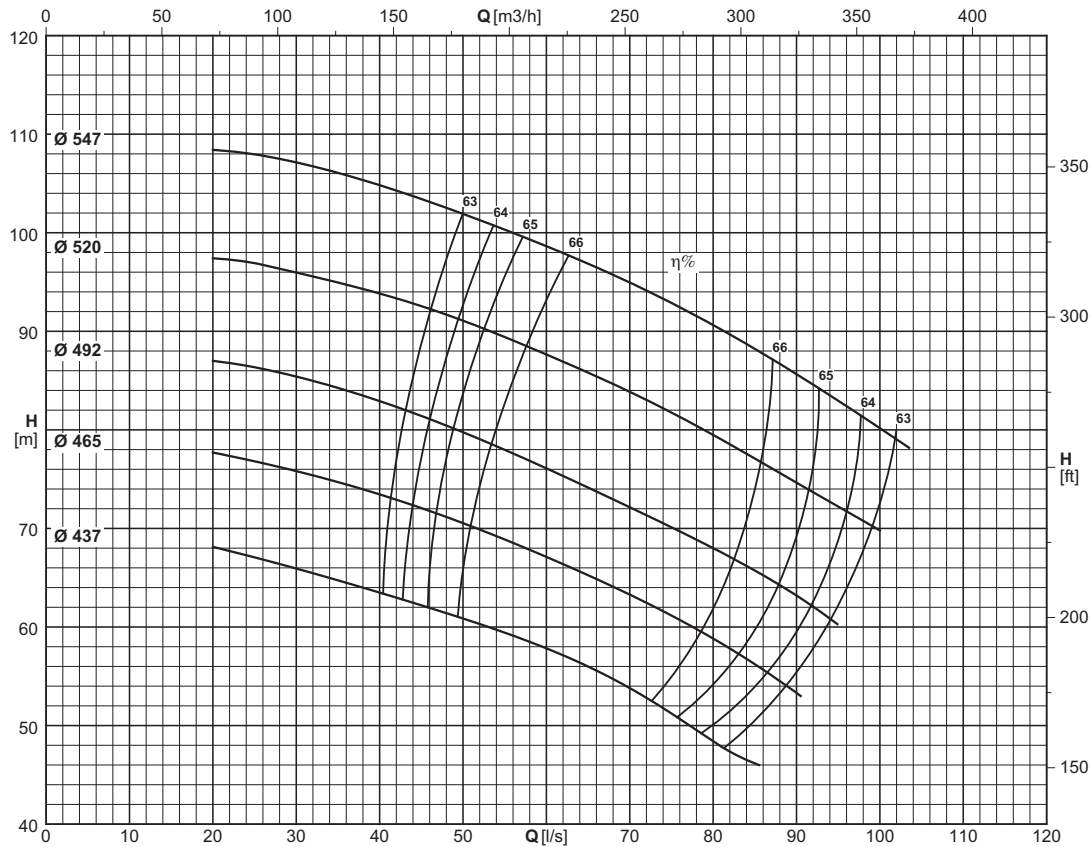

Type Type Tipo	Inlet maximum pressure (*) Pression maximale en aspiration (*) Pressione massima in aspirazione (*)	Dynamic momentum J Momentum dynamique J Momento dinamico J	
		With cast iron impellers Avec roues en fonte Con giranti in ghisa	With AISI 316 impellers Avec roues en AISI 316 Con giranti in AISI 316
	[bar]	J = 1/4 PD ² [kgm ²]	
NCH125-500	-	-	(F) -

(*) Value referred to the impeller with maximum diameter. (*) Valeur se référant à la roue à ailettes avec le diamètre maximum. (*) Valore riferito alla girante con diametro massimo

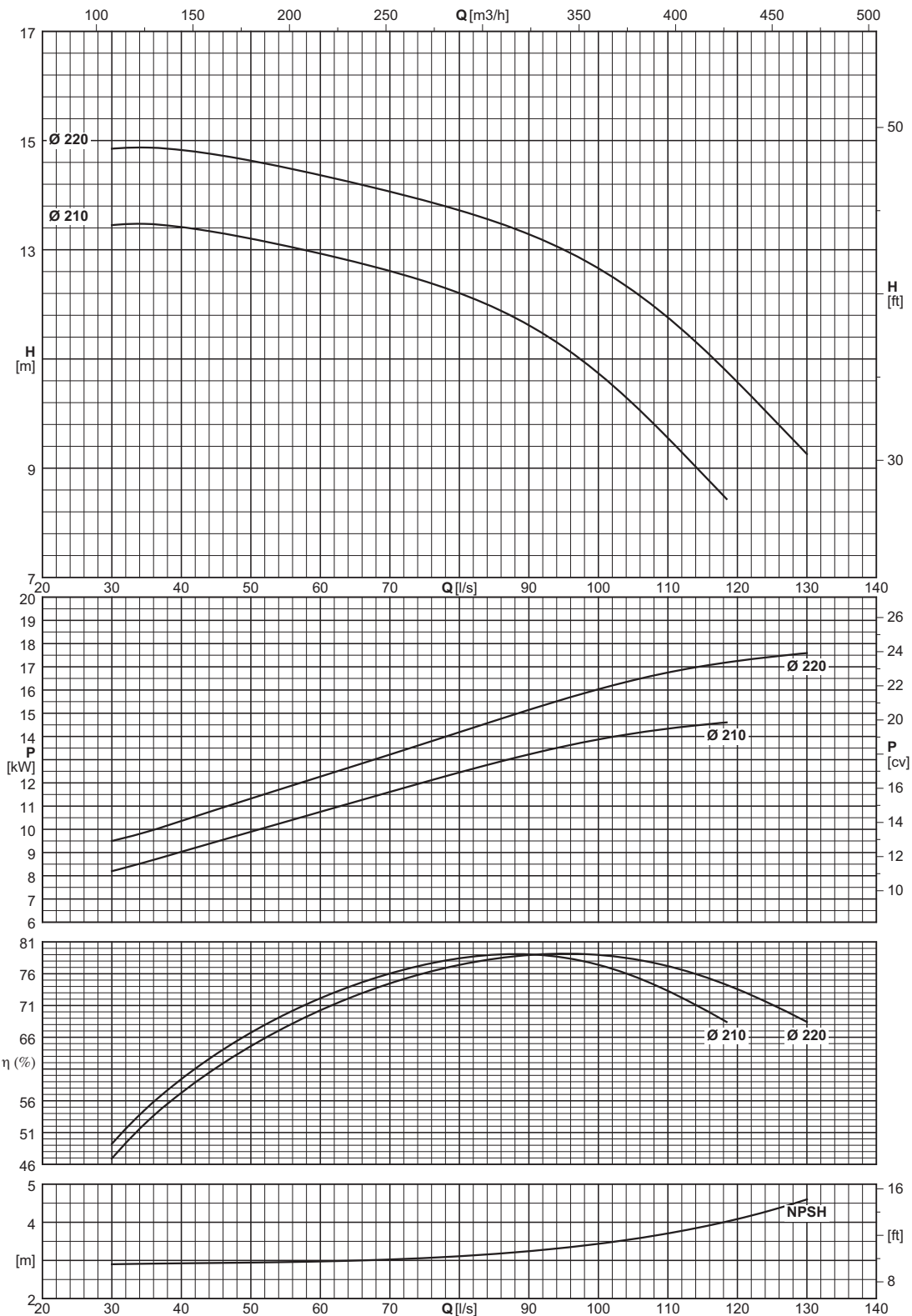

Type Type Tipo	Inlet maximum pressure (*) Pression maximale en aspiration (*) Pressione massima in aspirazione (*)	Dinamic momentum J Momentum dynamique J Momento dinamico J	
		With cast iron impellers Avec roues en fonte Con giranti in ghisa	With AISI 316 impellers Avec roues en AISI 316 Con giranti in AISI 316
		J=1/4PD ²	
	[bar]	[kgm ²]	
NC150-200	7	0,12500	(F) 0,13688

(*) Value referred to the impeller with maximum diameter.

(*) Valeur se référant à la roue à ailettes avec le diamètre maximum.

(*) Valore riferito alla girante con diametro massimo

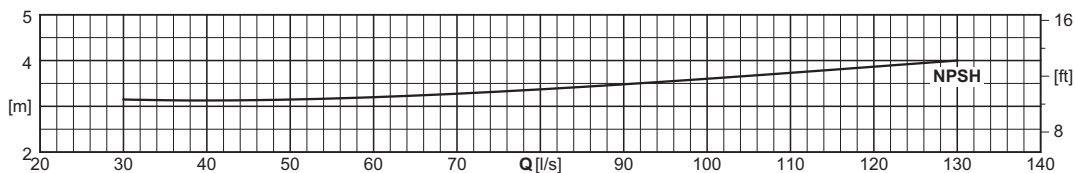
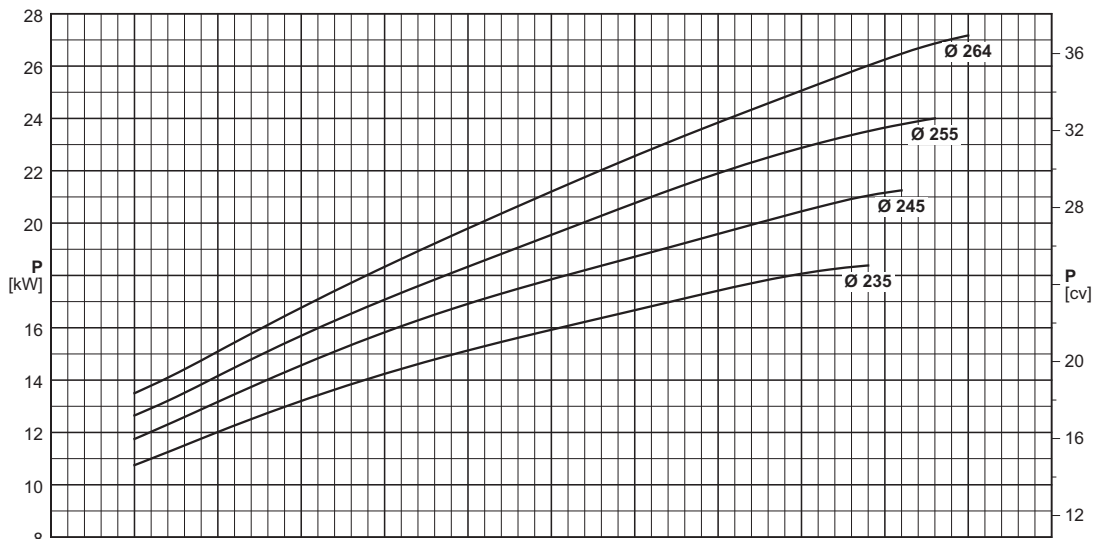
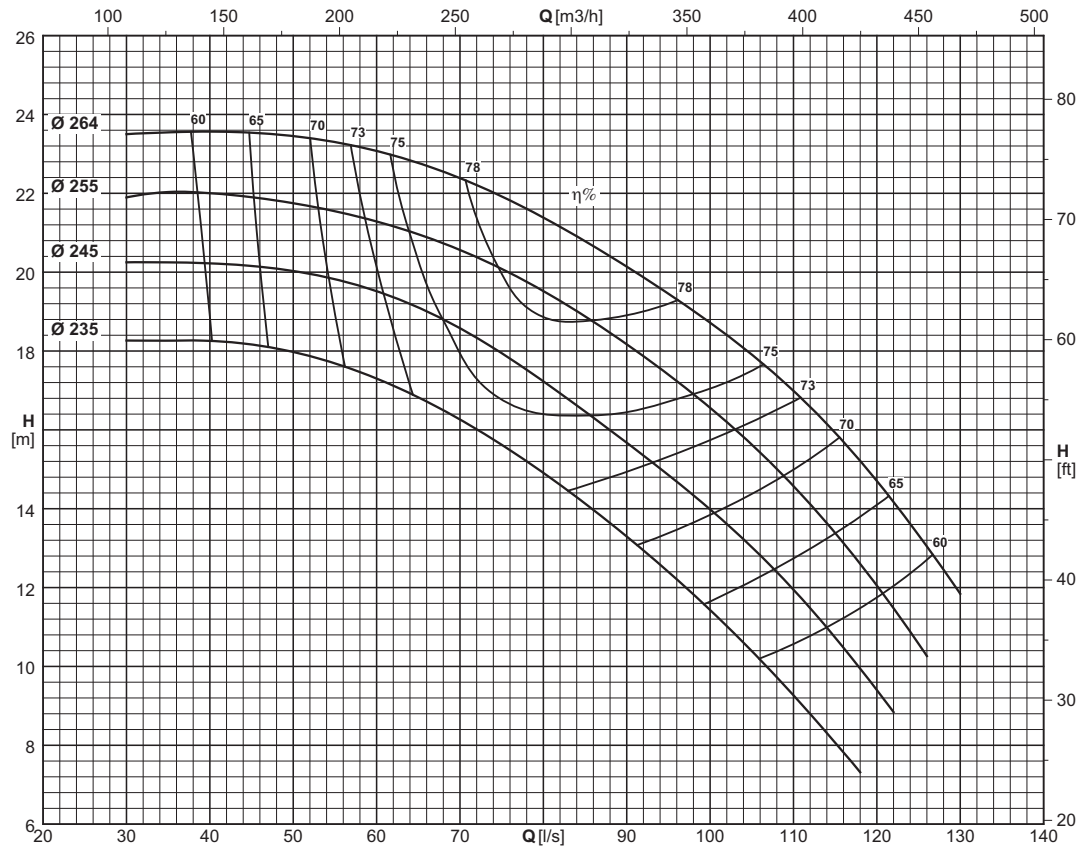

Type Type Tipo	Inlet maximum pressure (*) Pression maximale en aspiration (*) Pressione massima in aspirazione (*)	Dinamic momentum J Momentum dynamique J Momento dinamico J	
		With cast iron impellers Avec roues en fonte Con giranti in ghisa	With AISI 316 impellers Avec roues en AISI 316 Con giranti in AISI 316
		J=1/4PD ²	
[bar]		[kgm ²]	
NC150-250	6	0,16737	(F) 0,18327

(*) Value referred to the impeller with maximum diameter.

(*) Valeur se référant à la roue à ailettes avec le diamètre maximum.

(*) Valore riferito alla girante con diametro massimo

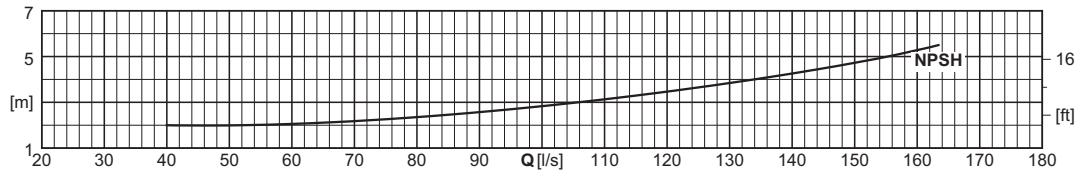
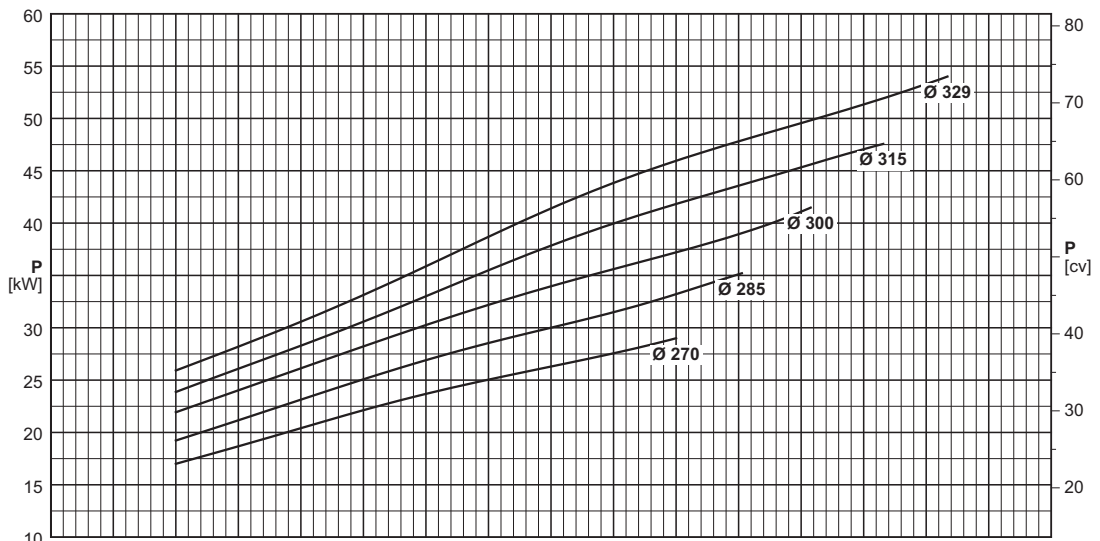
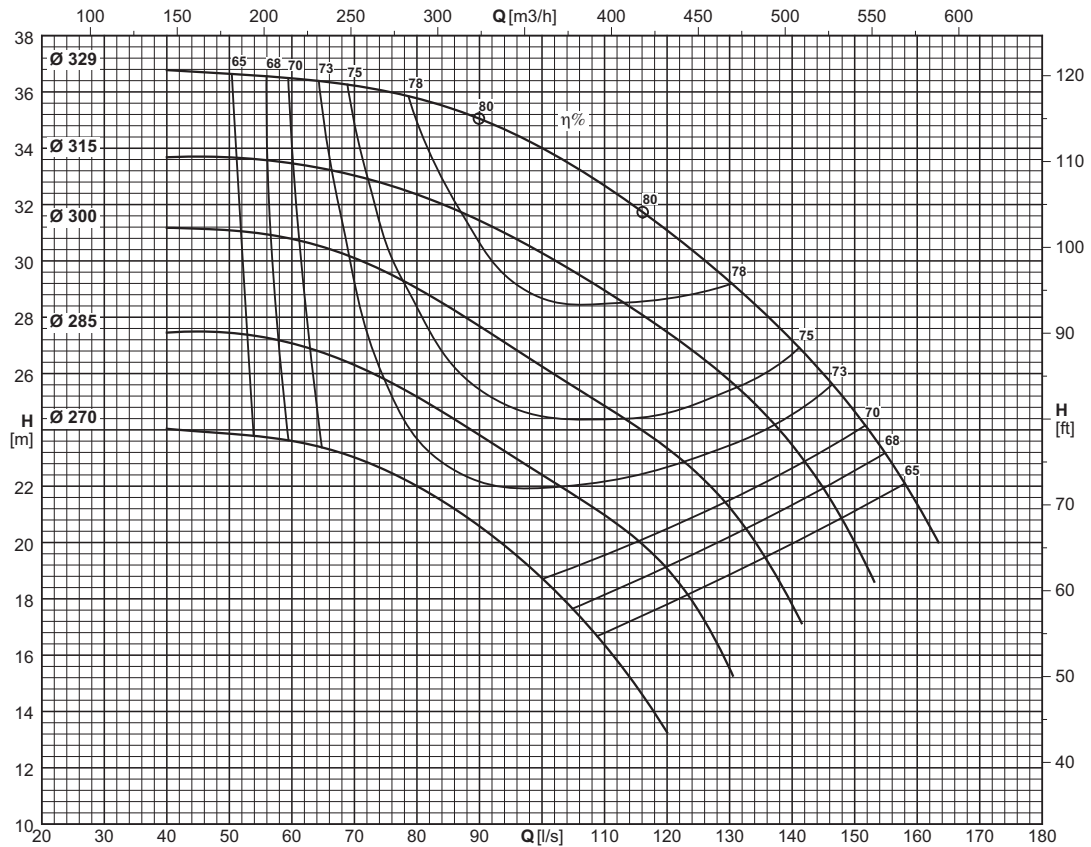

Type Type Tipo	Inlet maximum pressure (*) Pression maximale en aspiration (*) Pressione massima in aspirazione (*)	Dynamic momentum J Momentum dynamique J Momento dinamico J	
		With cast iron impellers Avec roues en fonte Con giranti in ghisa	With AISI 316 impellers Avec roues en AISI 316 Con giranti in AISI 316
		$J = \frac{1}{4}PD^2$	
	[bar]	[kgm ²]	
NC150-315	5	0,30307	(F) 0,33186

Construction reference standard EN733 (DIN24255)
(*) Value referred to the impeller with maximum diameter.

Norme de référence construction EN733 (DIN24255)
(*) Valeur se référant à la roue à ailettes avec le diamètre maximum.

Norma di riferimento costruttivo EN733 (DIN24255)
(*) Valore riferito alla girante con diametro massimo

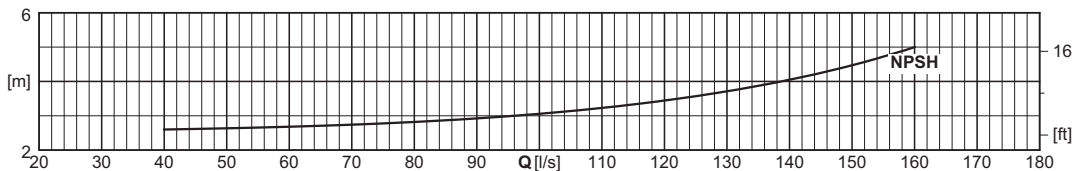
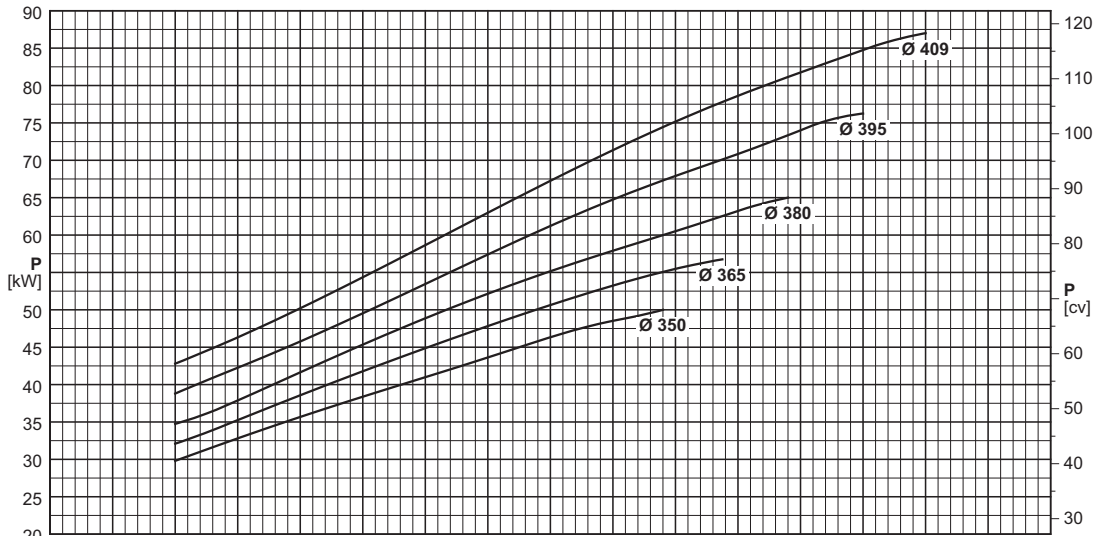
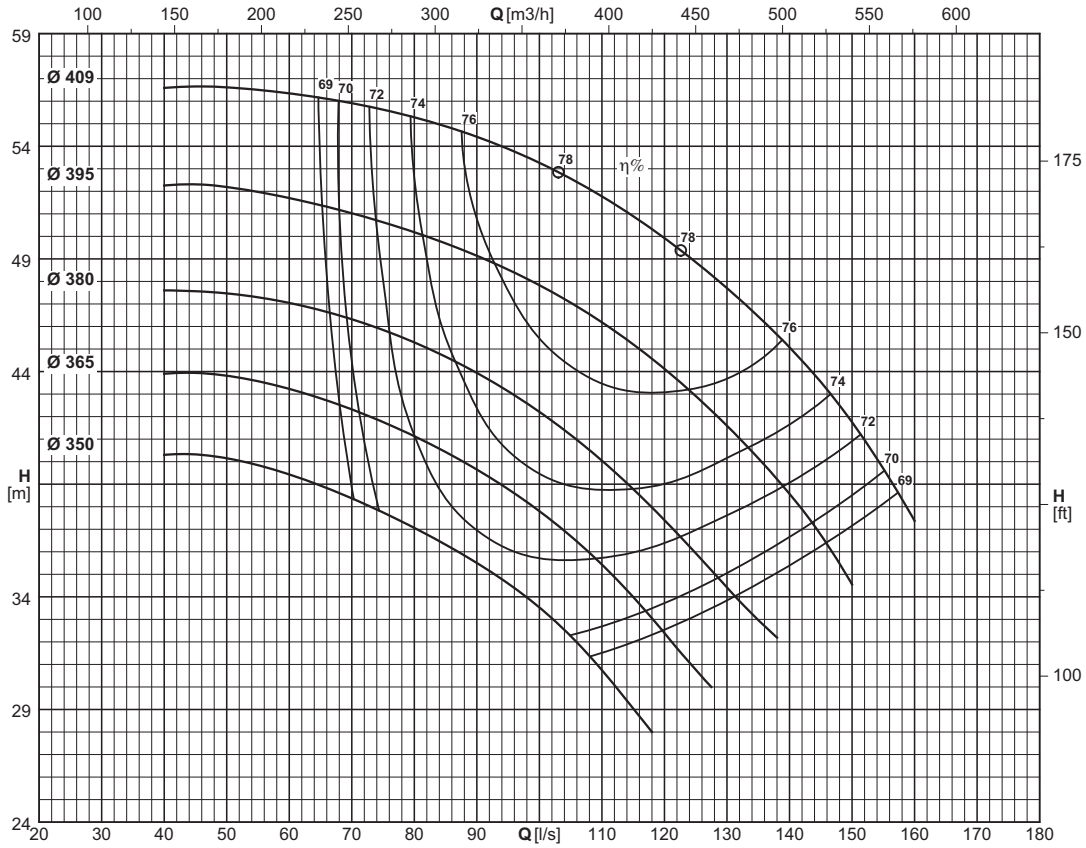

Type Type Tipo	Inlet maximum pressure (*) Pression maximale en aspiration (*) Pressione massima in aspirazione (*)	Dynamic momentum J Momentum dynamique J Momento dinamico J	
		With cast iron impellers Avec roues en fonte Con giranti in ghisa	With AISI 316 impellers Avec roues en AISI 316 Con giranti in AISI 316
		J=1/4PD ²	
	[bar]	[kgm ²]	[kgm ²]
NC150-400	3	0,76405	(F) 0,83664

Construction reference standard EN733 (DIN24255)
(*) Value referred to the impeller with maximum diameter.

Norme de référence construction EN733 (DIN24255)
(*) Valeur se référant à la roue à ailettes avec le diamètre maximum.

Norma di riferimento costruttivo EN733 (DIN24255)
(*) Valore riferito alla girante con diametro massimo

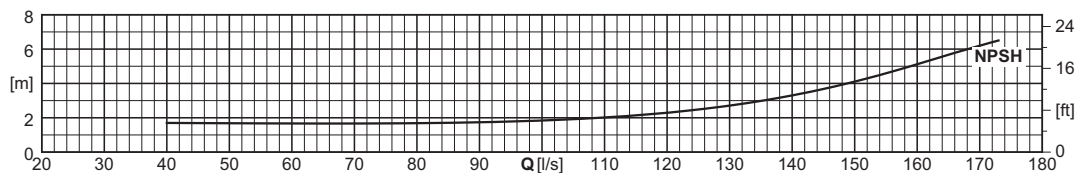
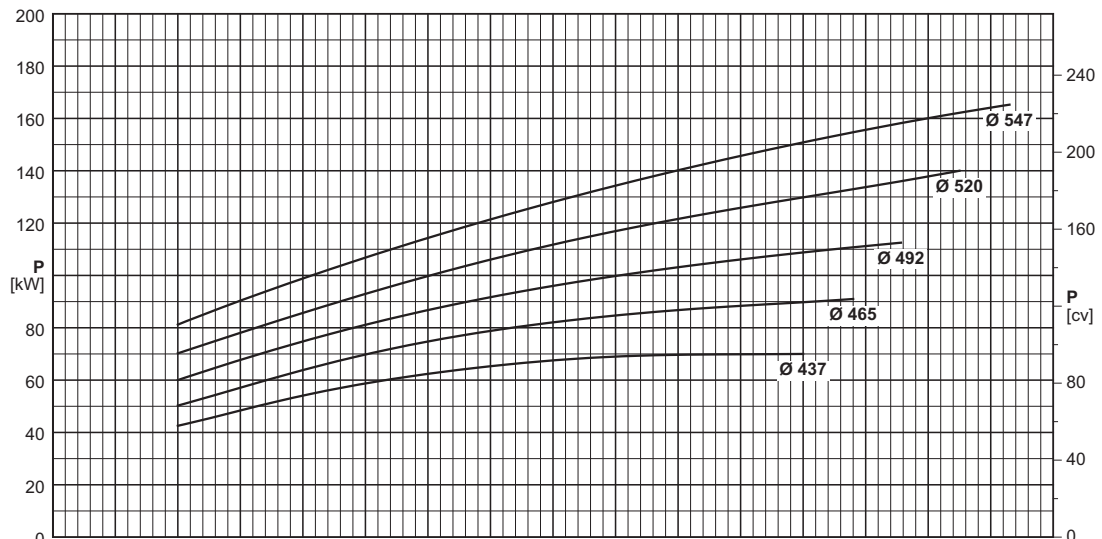
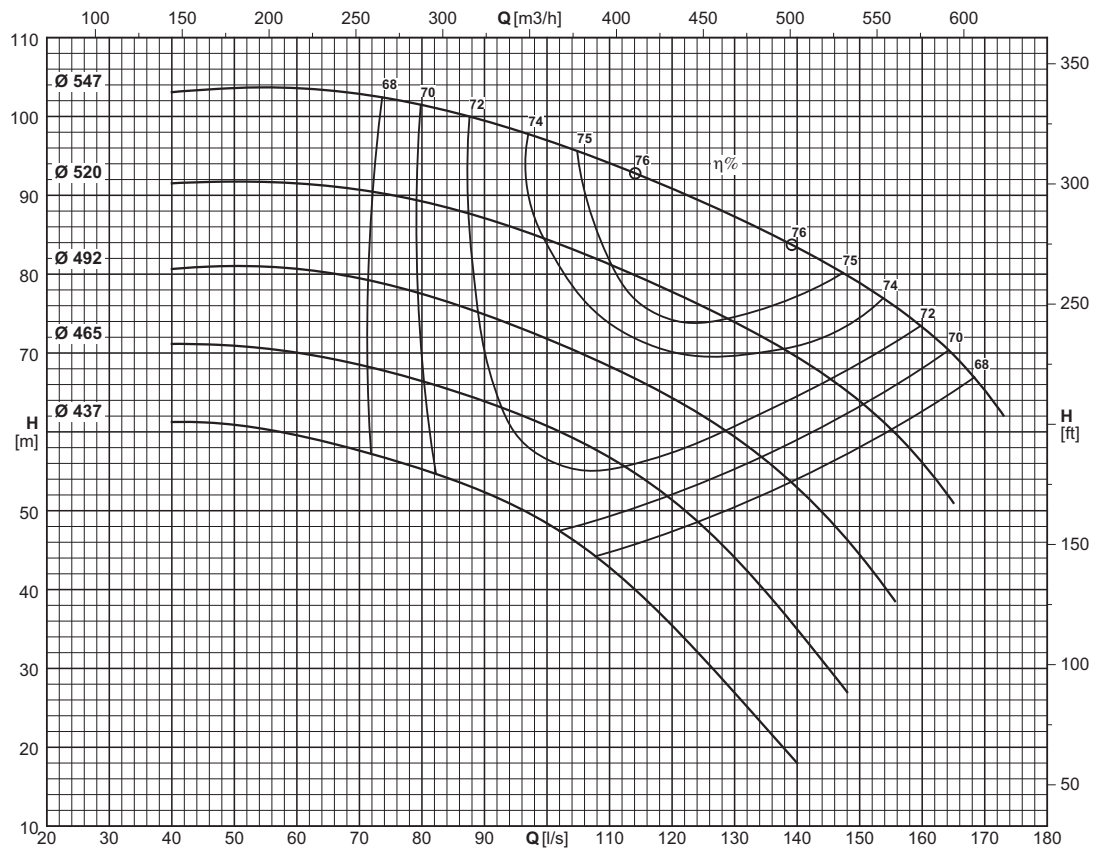

Type Type Tipo	Inlet maximum pressure (*) Pression maximale en aspiration (*) Pressione massima in aspirazione (*)	Dynamic momentum J Momentum dynamique J Momento dinamico J	
		With cast iron impellers Avec roues en fonte Con giranti in ghisa	With AISI 316 impellers Avec roues en AISI 316 Con giranti in AISI 316
		J=1/4PD ²	
[bar]		[kgm ²]	
NCH150-500	5	0,869	(F) 0,954

(*) Value referred to the impeller with maximum diameter.

(*) Valeur se référant à la roue à ailettes avec le diamètre maximum.

(*) Valore riferito alla girante con diametro massimo

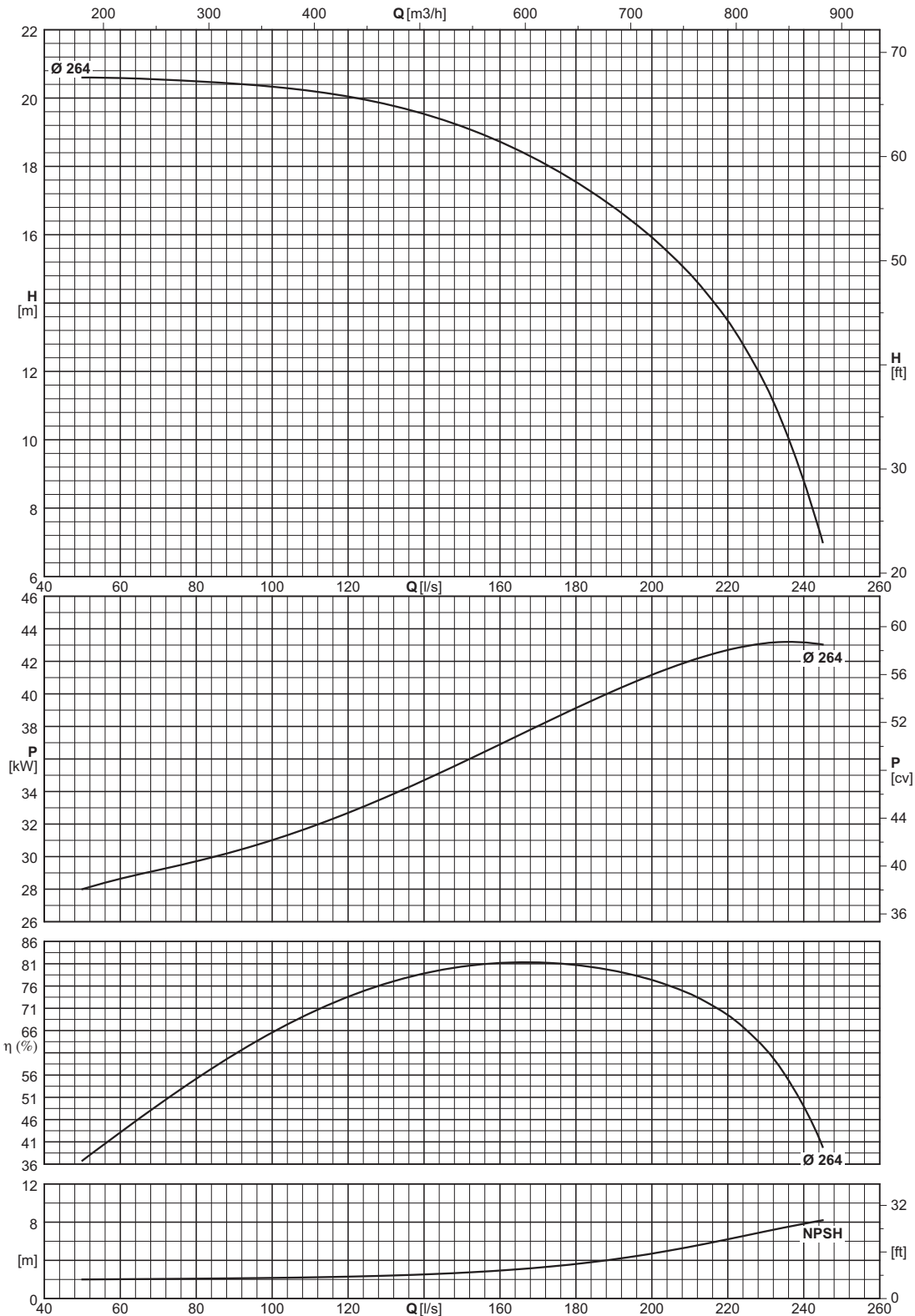

Type Type Tipo	Inlet maximum pressure (*) Pression maximale en aspiration (*) Pressione massima in aspirazione (*)	Dynamic momentum J Momentum dynamique J Momento dinamico J	
		With cast iron impellers Avec roues en fonte Con giranti in ghisa	With AISI 316 impellers Avec roues en AISI 316 Con giranti in AISI 316
		J=1/4PD²	
	[bar]	[kgm²]	
NC200-250	6	0,17500	(F) 0,19163

(*) Value referred to the impeller with maximum diameter. (*) Valeur se référant à la roue à ailettes avec le diamètre maximum. (*) Valore riferito alla girante con diametro massimo

Operating data
 Caracteristiques de fonctionnement
 Caratteristiche di funzionamento

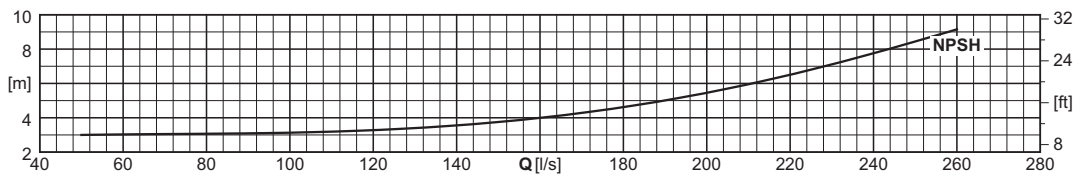
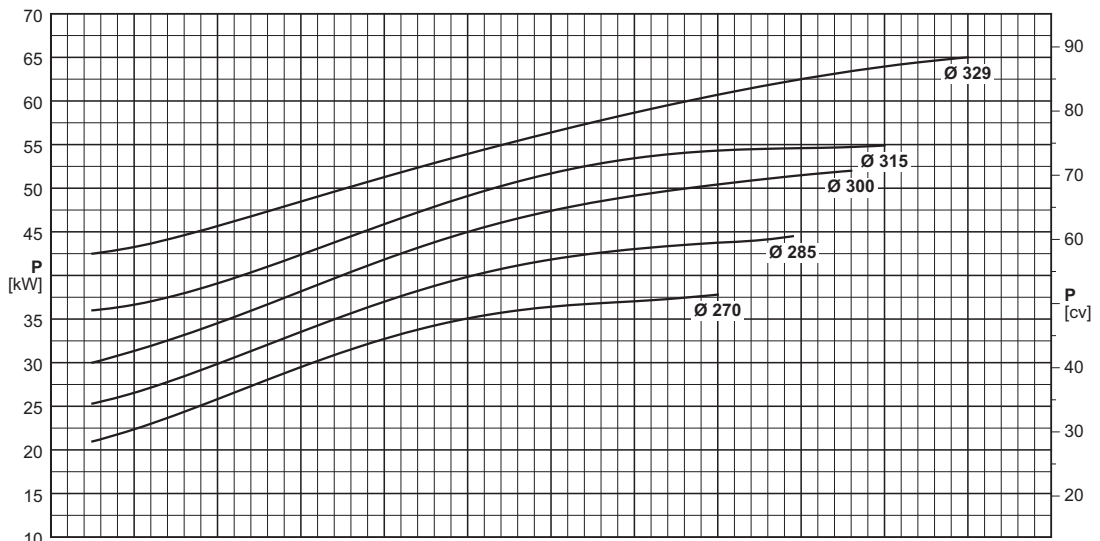
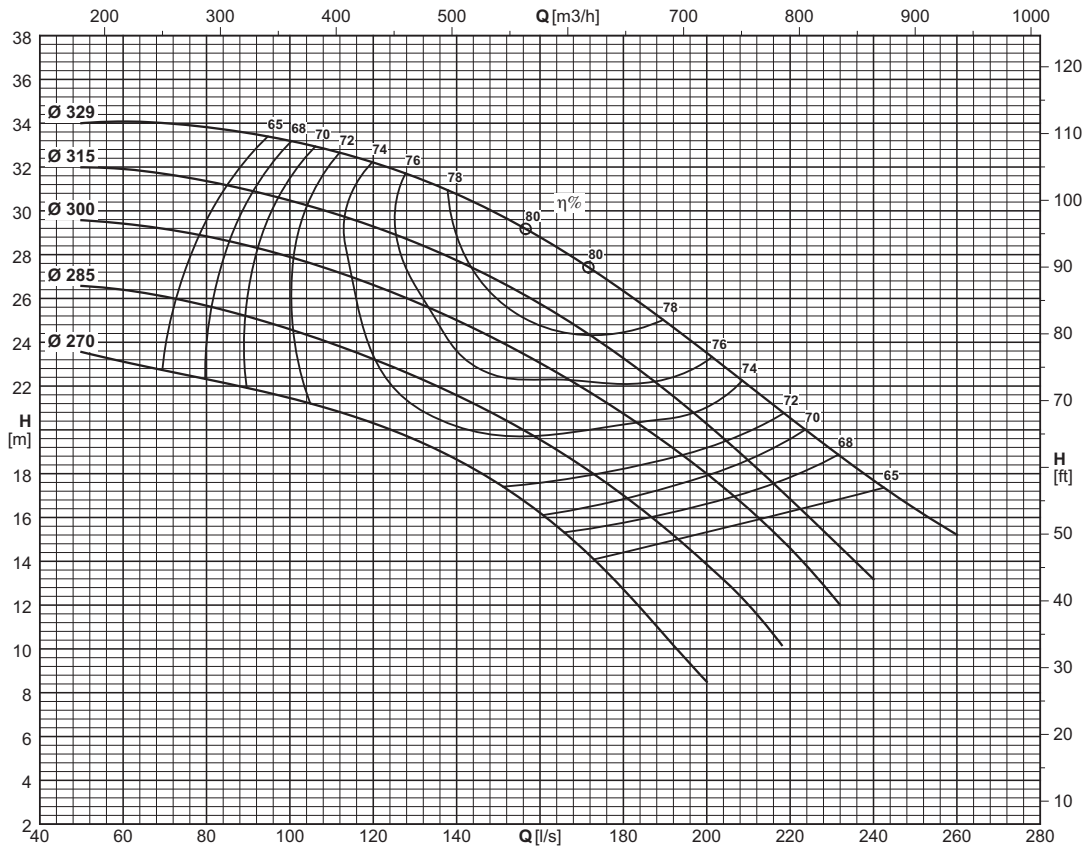

Type Type Tipo	Inlet maximum pressure (*) Pression maximale en aspiration (*) Pressione massima in aspirazione (*)	Dynamic momentum J Momentum dynamique J Momento dinamico J	
		With cast iron impellers Avec roues en fonte Con giranti in ghisa	With AISI 316 impellers Avec roues en AISI 316 Con giranti in AISI 316
		J=1/4PD ²	
[bar]		[kgm ²]	
NC200-315	5	0,33769	(F) 0,36977

(*) Value referred to the impeller with maximum diameter.

(*) Valeur se référant à la roue à ailettes avec le diamètre maximum.

(*) Valore riferito alla girante con diametro massimo

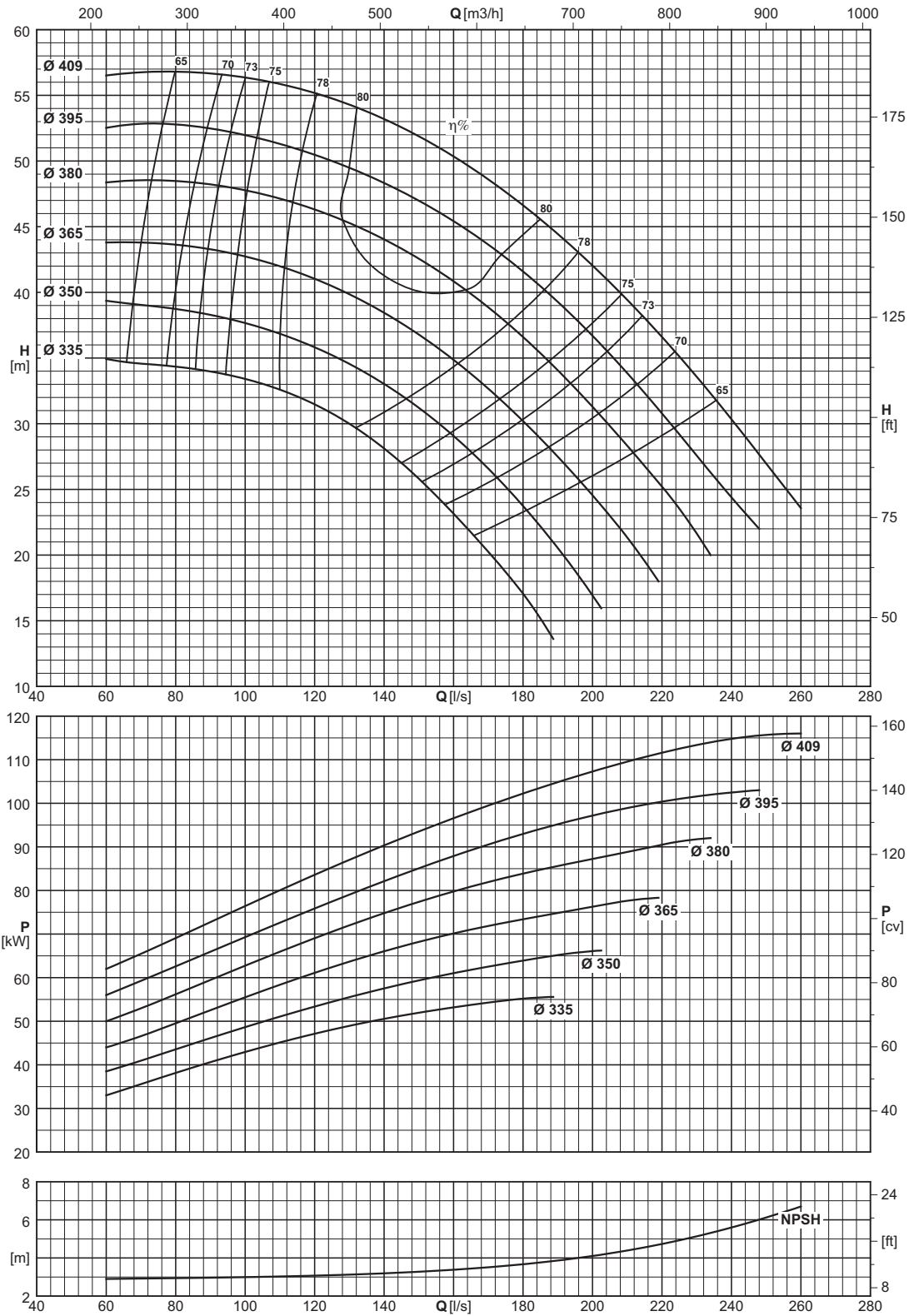

Type Type Tipo	Inlet maximum pressure (*) Pression maximale en aspiration (*) Pressione massima in aspirazione (*)	Dynamic momentum J Momentum dynamique J Momento dinamico J	
		With cast iron impellers Avec roues en fonte Con giranti in ghisa	With AISI 316 impellers Avec roues en AISI 316 Con giranti in AISI 316
		J=1/4PD ²	
[bar]		[kgm ²]	
NC200-400	3	0,91963	(F) 1,00700

(*) Value referred to the impeller with maximum diameter.

(*) Valeur se référant à la roue à ailettes avec le diamètre maximum.

(*) Valore riferito alla girante con diametro massimo

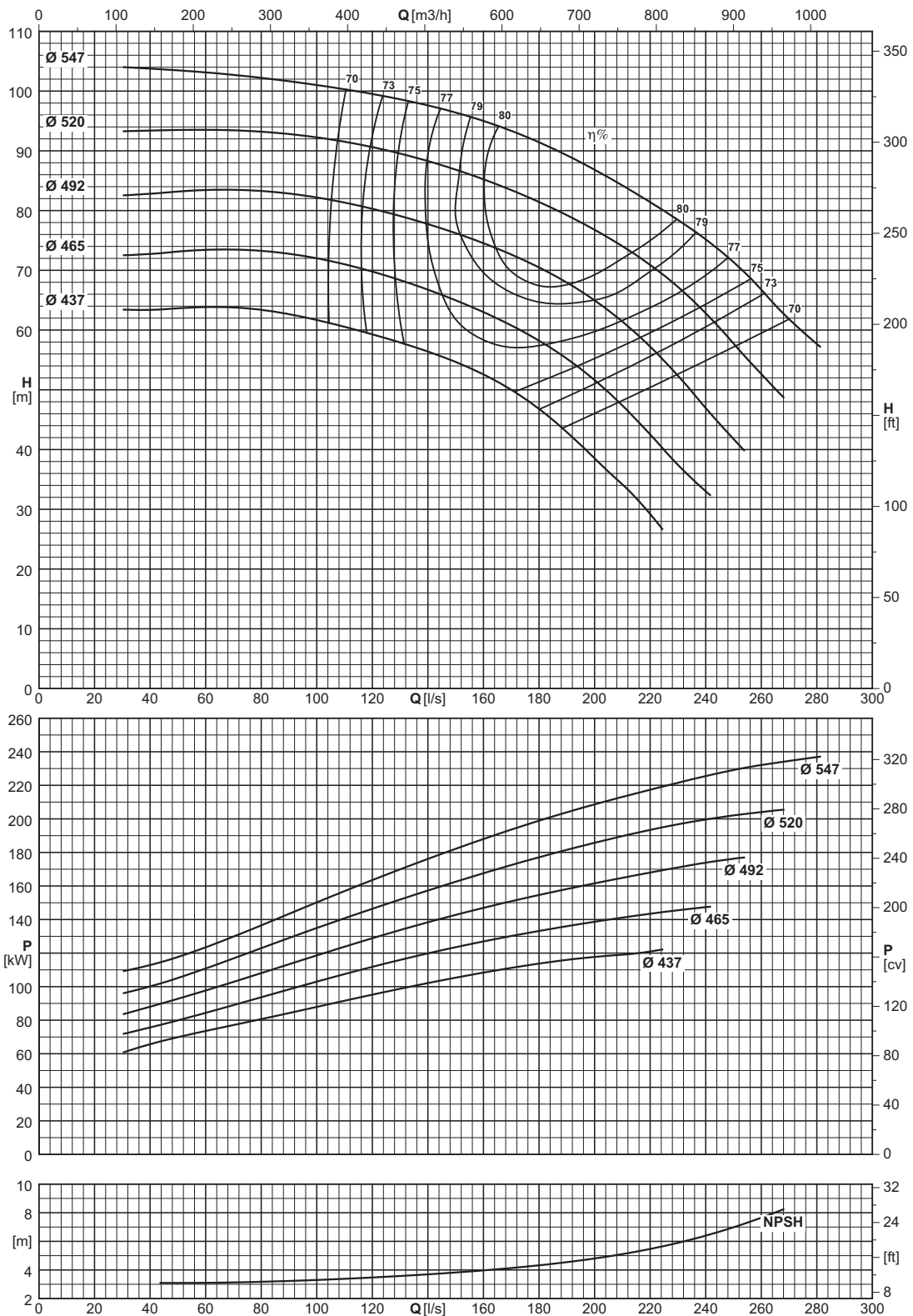

Type Type Tipo	Inlet maximum pressure (*) Pression maximale en aspiration (*) Pressione massima in aspirazione (*)	Dynamic momentum J Momentum dynamique J Momento dinamico J	
		With cast iron impellers Avec roues en fonte Con giranti in ghisa	With AISI 316 impellers Avec roues en AISI 316 Con giranti in AISI 316
		J=1/4PD²	
	[bar]	[kgm²]	
NCH200-500	-	-	(F) -

(*) Value referred to the impeller with maximum diameter.

(*) Valeur se référant à la roue à ailettes avec le diamètre maximum.

(*) Valore riferito alla girante con diametro massimo

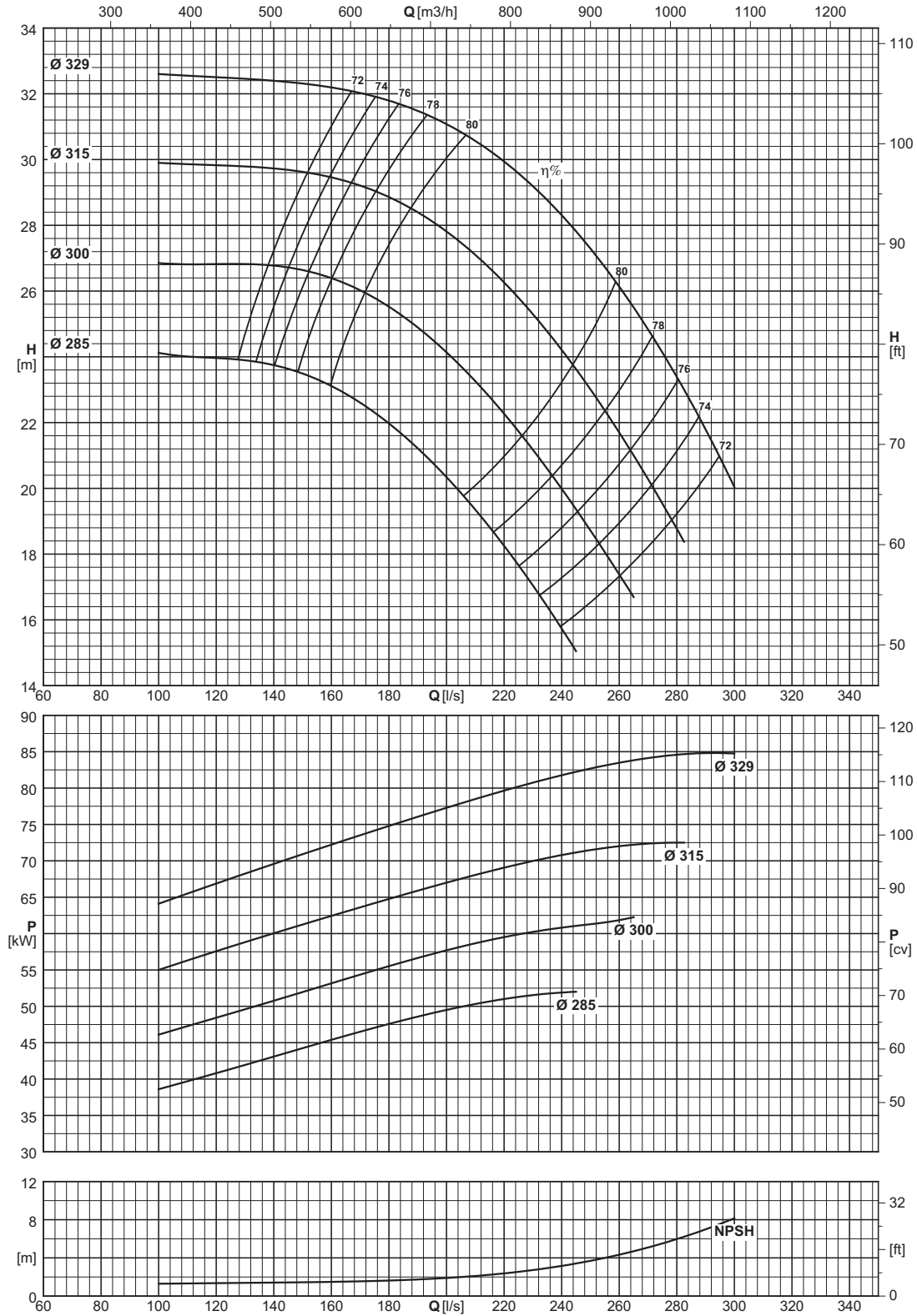

Type Type Tipo	Inlet maximum pressure (*) Pression maximale en aspiration (*) Pressione massima in aspirazione (*)	Dynamic momentum J Momentum dynamique J Momento dinamico J	
		With cast iron impellers Avec roues en fonte Con giranti in ghisa	With AISI 316 impellers Avec roues en AISI 316 Con giranti in AISI 316
		J = 1/4 PD ²	
	[bar]	[kgm ²]	
NC250-315	5	0,37635	(F) 0,41210

(*) Value referred to the impeller with maximum diameter.

(*) Valeur se référant à la roue à ailettes avec le diamètre maximum.

(*) Valore riferito alla girante con diametro massimo

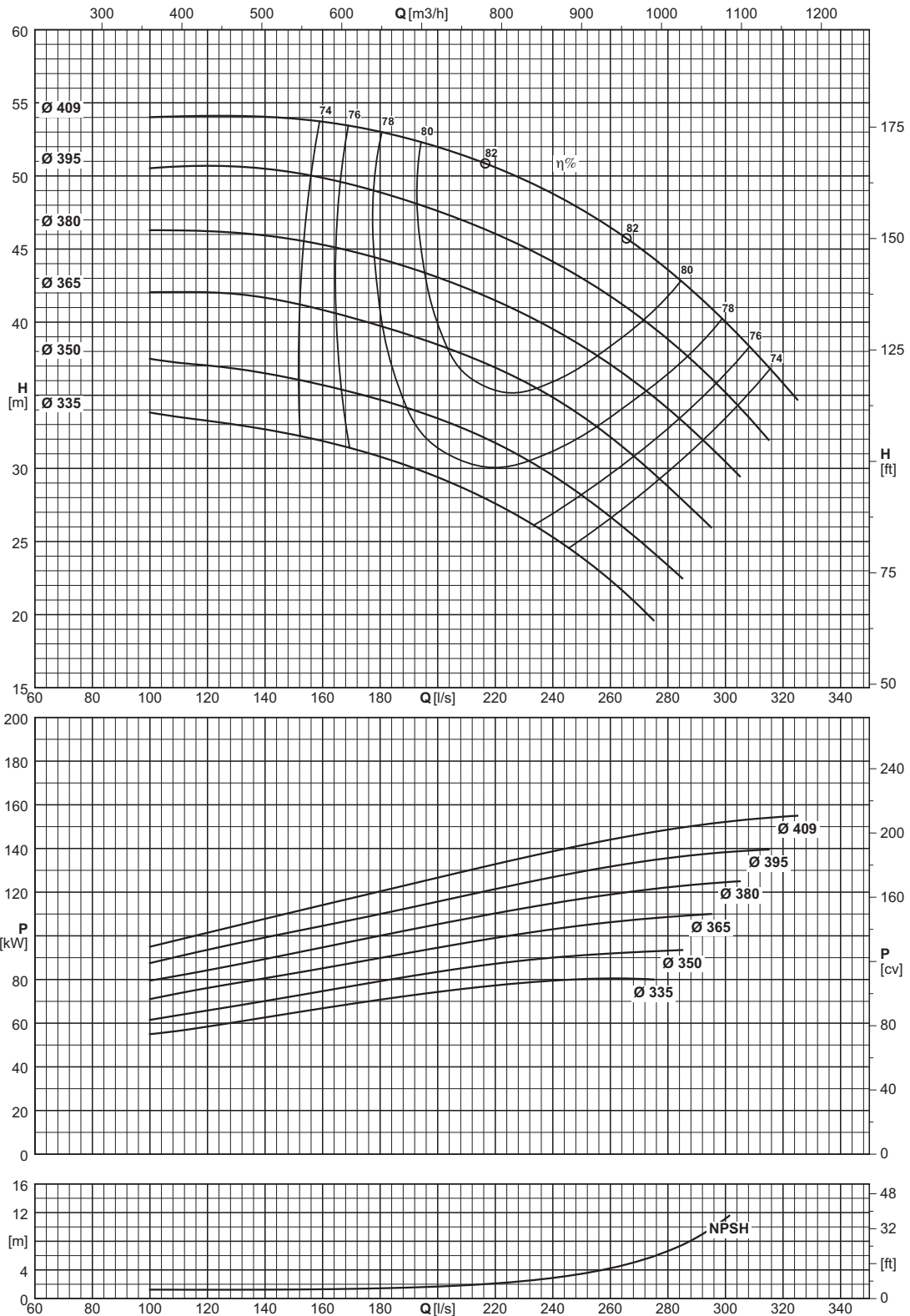

Type Type Tipo	Inlet maximum pressure (*) Pression maximale en aspiration (*) Pressione massima in aspirazione (*)	Dynamic momentum J Momentum dynamique J Momento dinamico J	
		With cast iron impellers Avec roues en fonte Con giranti in ghisa	With AISI 316 impellers Avec roues en AISI 316 Con giranti in AISI 316
		$J = \frac{1}{4}PD^2$	
	[bar]	[kgm ²]	
NC250-400	3	1,02492	(F) 1,12229

(*) Value referred to the impeller with maximum diameter.

(*) Valeur se référant à la roue à ailettes avec le diamètre maximum.

(*) Valore riferito alla girante con diametro massimo

NCH 250-250

1450 n [min⁻¹]



Operating data
Caracteristiques de fonctionnement
Caratteristiche di funzionamento

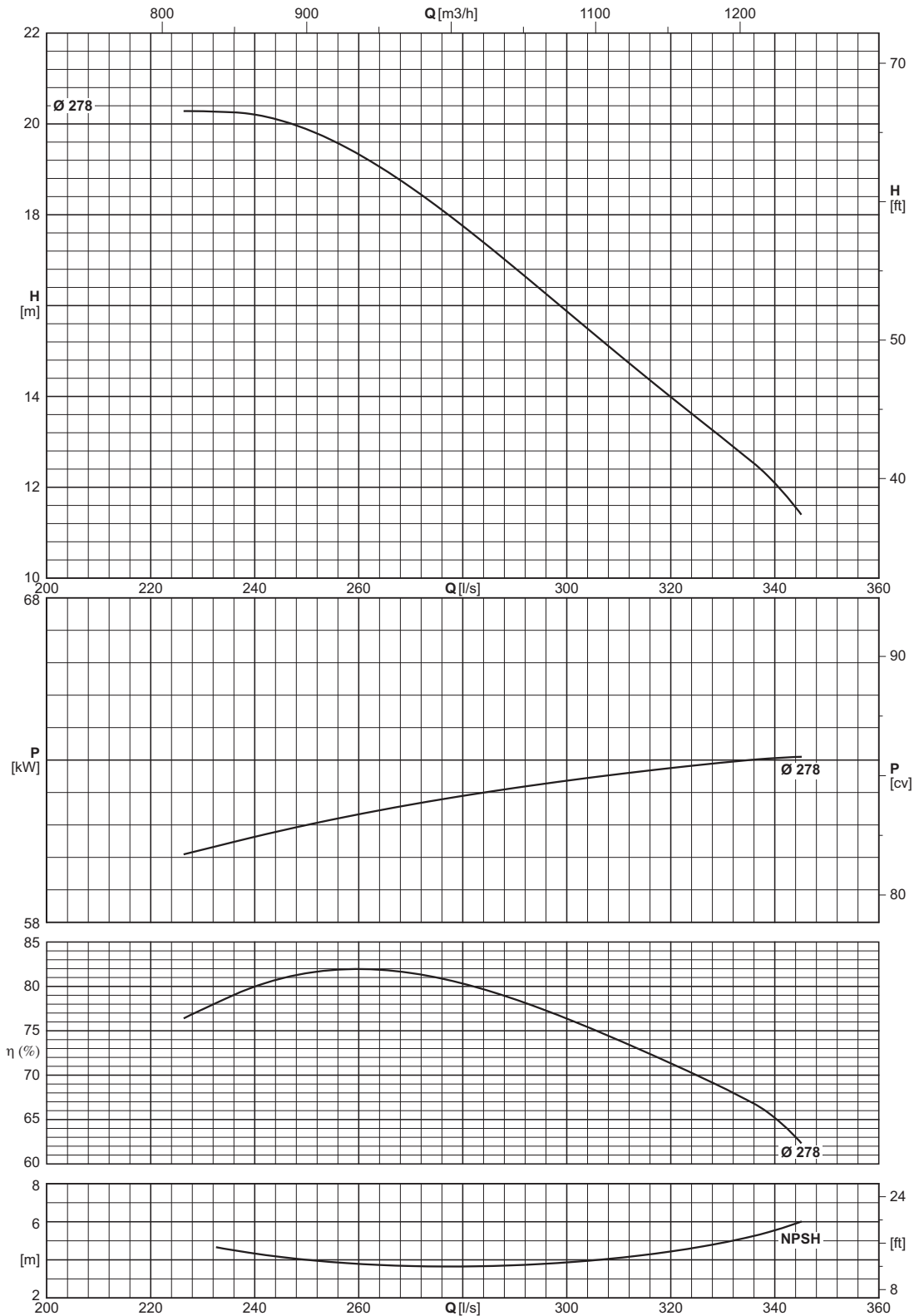

Type Type Tipo	Inlet maximum pressure (*) Pression maximale en aspiration (*) Pressione massima in aspirazione (*)	Dynamic momentum J Momentum dynamique J Momento dinamico J	
		With cast iron impellers Avec roues en fonte Con giranti in ghisa	With AISI 316 impellers Avec roues en AISI 316 Con giranti in AISI 316
		J=1/4PD ²	
[bar]		[kgm ²]	
NCH250-250	6	-	(F) -

(*) Value referred to the impeller with maximum diameter.

(*) Valeur se référant à la roue à ailettes avec le diamètre maximum.

(*) Valore riferito alla girante con diametro massimo

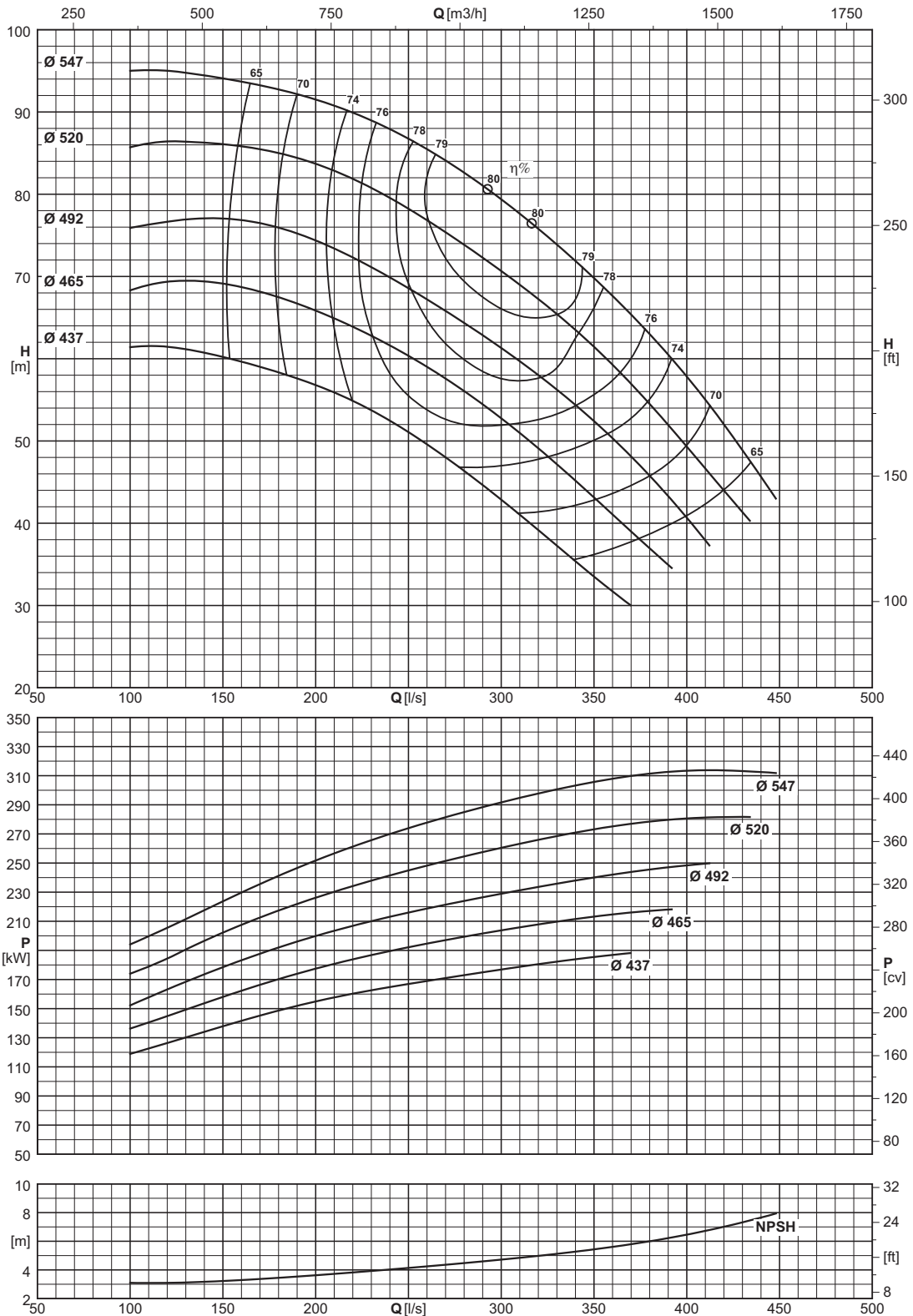

Type Type Tipo	Inlet maximum pressure (*) Pression maximale en aspiration (*) Pressione massima in aspirazione (*)	Dynamic momentum J Momentum dynamique J Momento dinamico J	
		With cast iron impellers Avec roues en fonte Con giranti in ghisa	With AISI 316 impellers Avec roues en AISI 316 Con giranti in AISI 316
		J=1/4PD²	
	[bar]	[kgm²]	[kgm²]
NCHF250-500	0.5	-	(F) -

(*) Value referred to the impeller with maximum diameter.

(*) Valeur se référant à la roue à ailettes avec le diamètre maximum.

(*) Valore riferito alla girante con diametro massimo

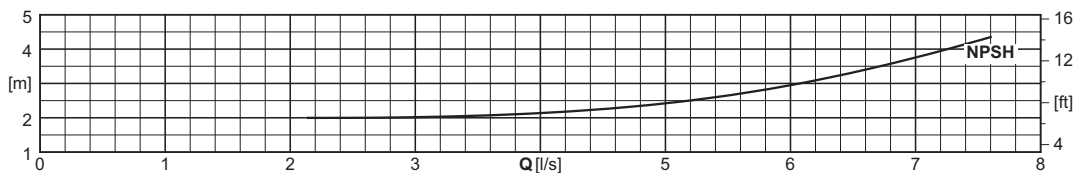
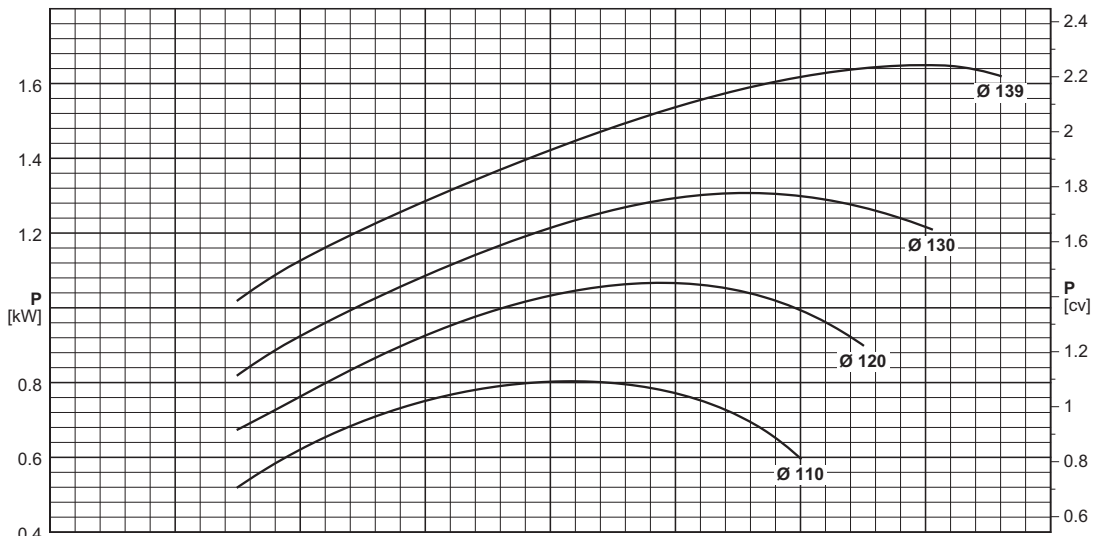
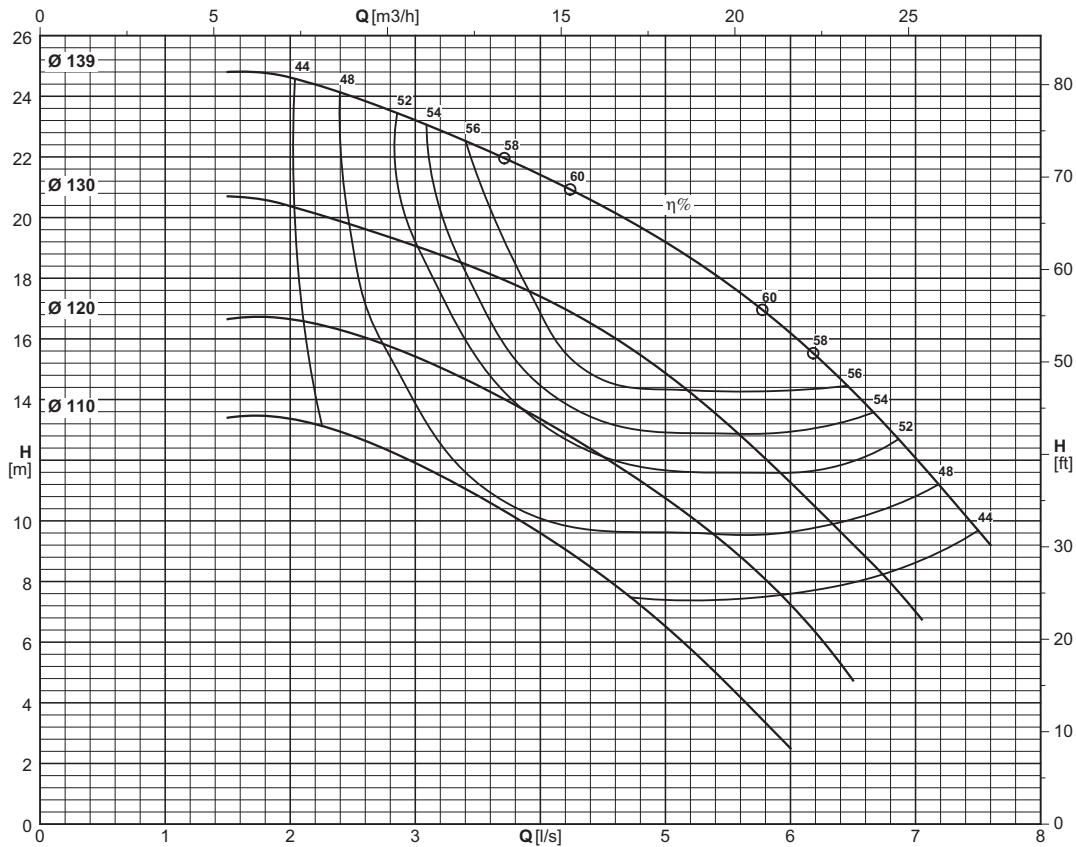

Type Type Tipo	Inlet maximum pressure (*) Pression maximale en aspiration (*) Pressione massima in aspirazione (*)	Dynamic momentum J Momentum dynamique J Momento dinamico J	
		With cast iron impellers Avec roues en fonte Con giranti in ghisa	With AISI 316 impellers Avec roues en AISI 316 Con giranti in AISI 316
	[bar]	J=1/4PD ² [kgm ²]	
NC32-125	6	0,00290	(F) 0,00318

Construction reference standard EN733 (DIN24255)
 (*) Value referred to the impeller with maximum diameter.

Norme de référence construction EN733 (DIN24255)
 (*) Valeur se référant à la roue à ailettes avec le diamètre maximum.

Norma di riferimento costruttivo EN733 (DIN24255)
 (*) Valore riferito alla girante con diametro massimo

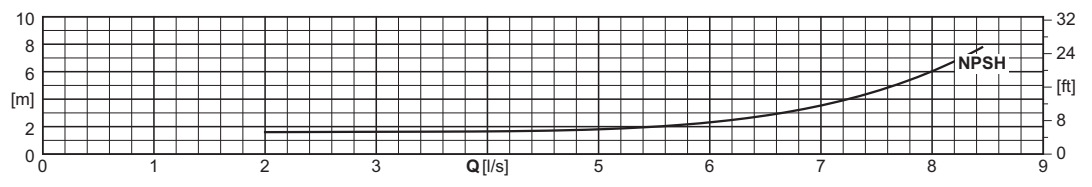
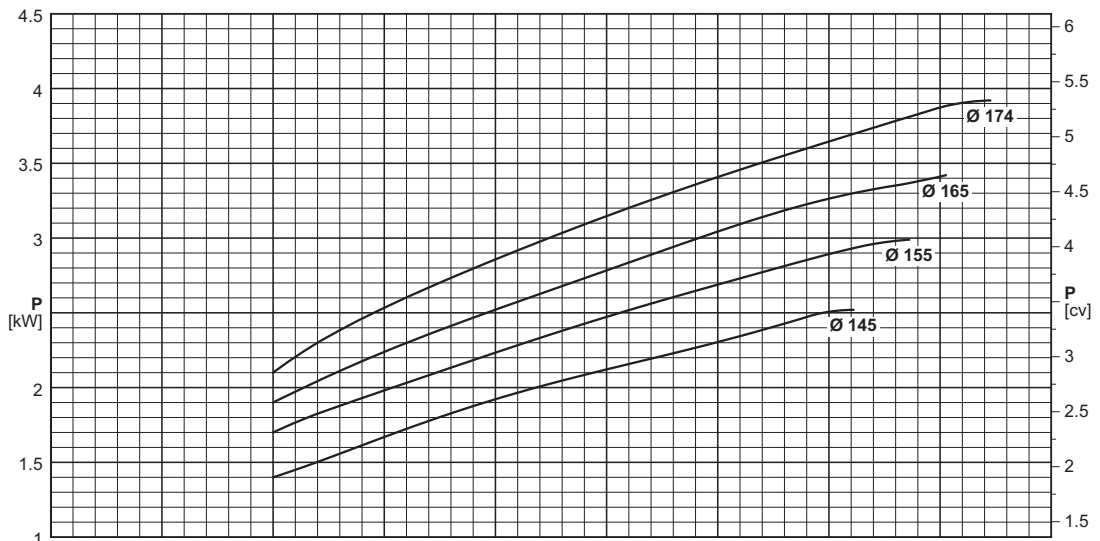
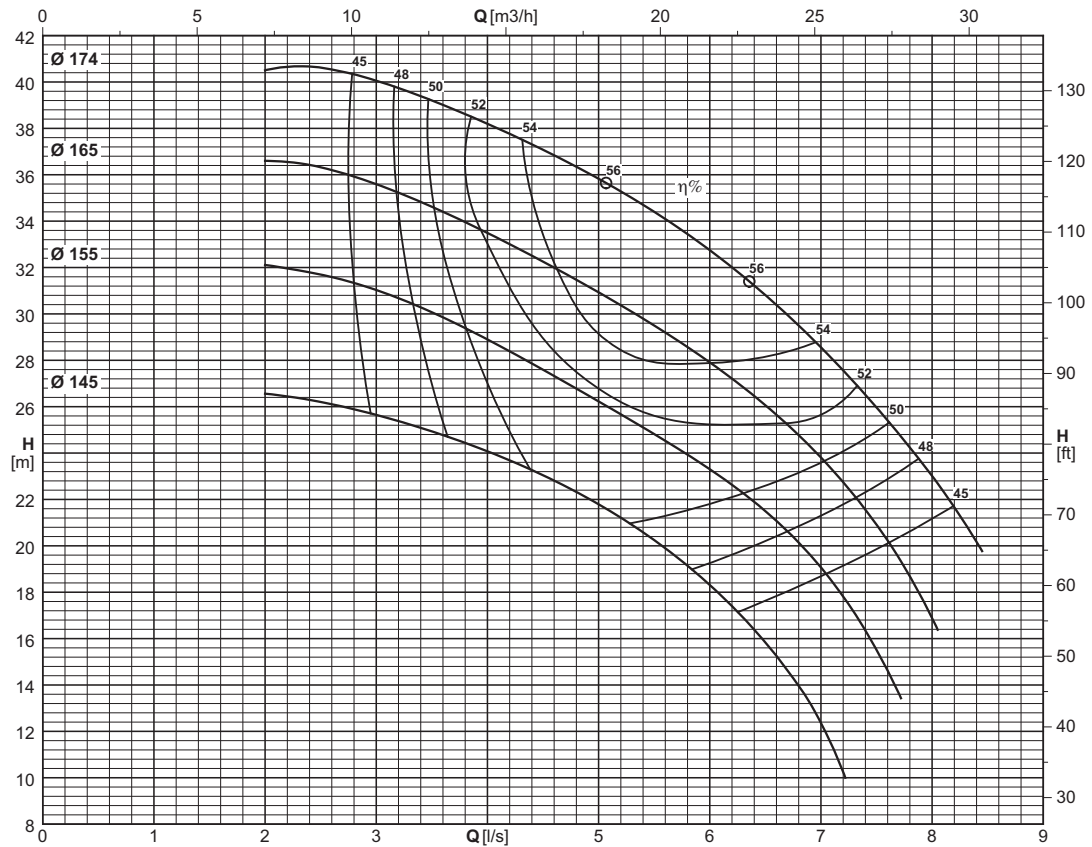

Type Type Tipo	Inlet maximum pressure (*) Pression maximale en aspiration (*) Pressione massima in aspirazione (*)	Dynamic momentum J Momentum dynamique J Momento dinamico J	
		With cast iron impellers Avec roues en fonte Con giranti in ghisa	With AISI 316 impellers Avec roues en AISI 316 Con giranti in AISI 316
		$J = \frac{1}{4}PD^2$	
	[bar]	[kgm ²]	
NC32-160	5	0,01015	(F) 0,01112

Construction reference standard EN733 (DIN24255)
 (*) Value referred to the impeller with maximum diameter.

Norme de référence construction EN733 (DIN24255)
 (*) Valeur se référant à la roue à ailettes avec le diamètre maximum.

Norma di riferimento costruttivo EN733 (DIN24255)
 (*) Valore riferito alla girante con diametro massimo

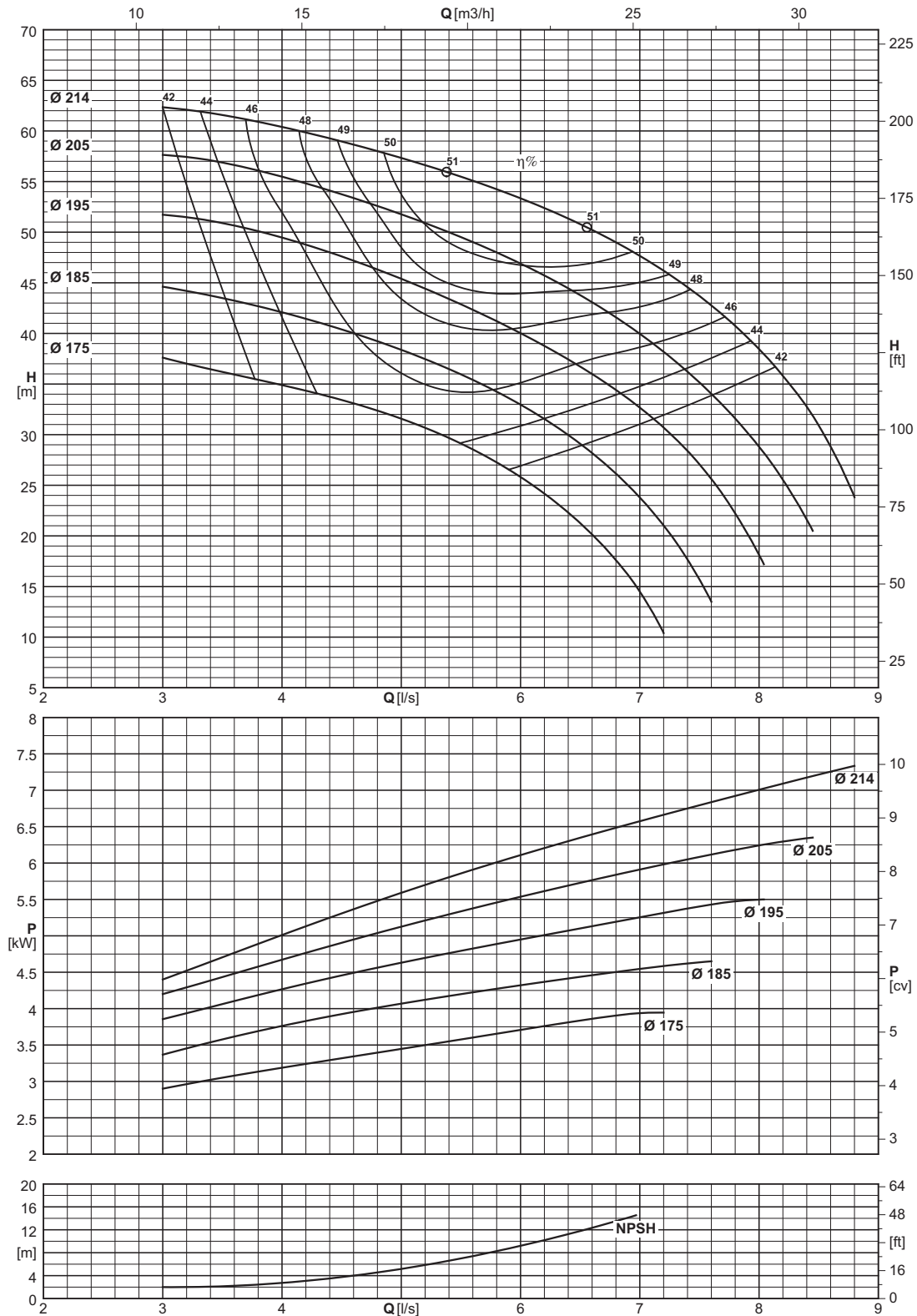

Type Type Tipo	Inlet maximum pressure (*) Pression maximale en aspiration (*) Pressione massima in aspirazione (*)	Dynamic momentum J Momentum dynamique J Momento dinamico J	
		With cast iron impellers Avec roues en fonte Con giranti in ghisa	With AISI 316 impellers Avec roues en AISI 316 Con giranti in AISI 316
		J=1/4PD²	
[bar]		[kgm²]	
NC32-200	2	0,02301	(F) 0,02520

Construction reference standard EN733 (DIN24255)
 (*) Value referred to the impeller with maximum diameter.

Norme de référence construction EN733 (DIN24255)
 (*) Valeur se référant à la roue à ailettes avec le diamètre maximum.

Norma di riferimento costruttivo EN733 (DIN24255)
 (*) Valore riferito alla girante con diametro massimo

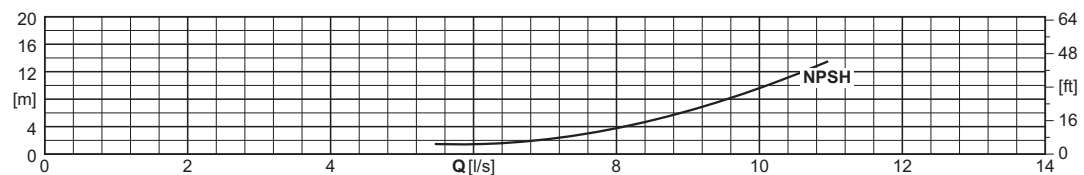
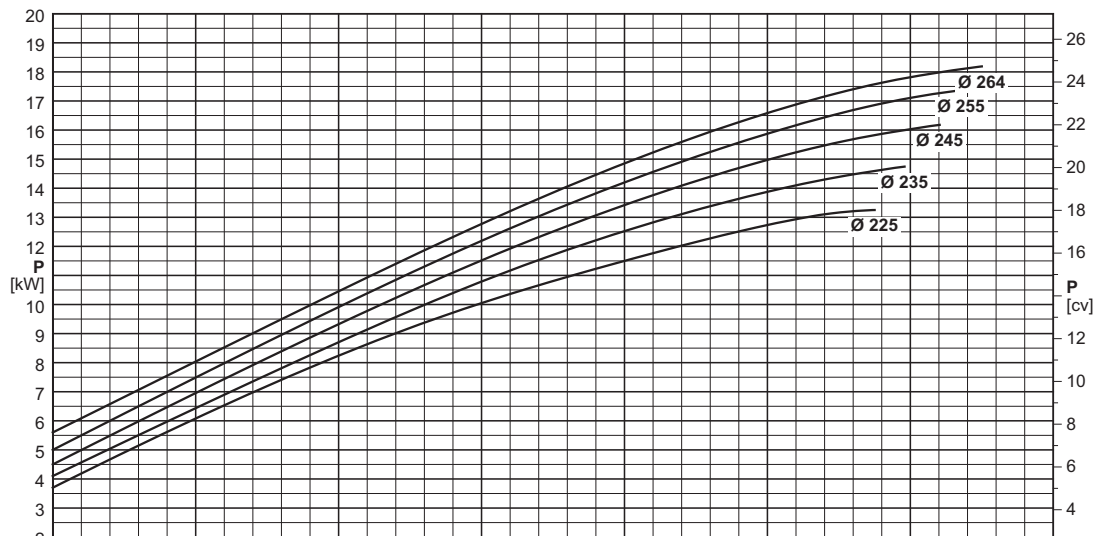
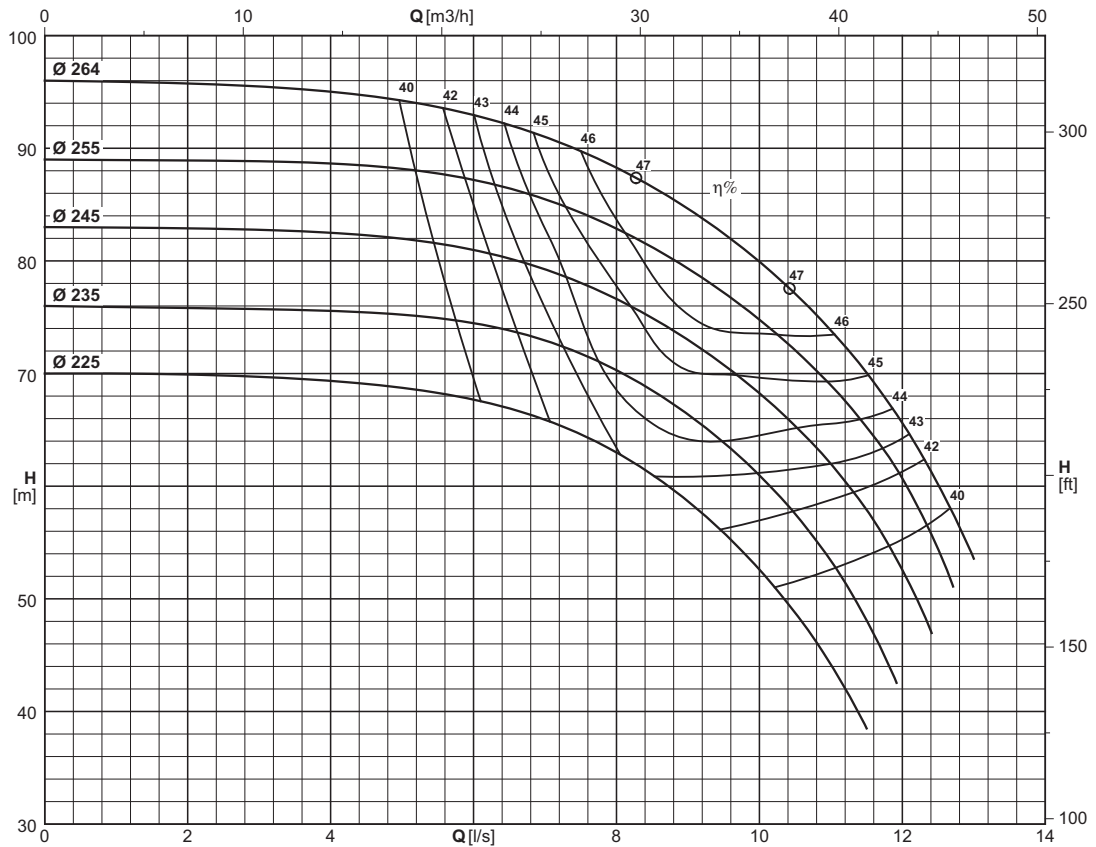

Type Type Tipo	Inlet maximum pressure (*) Pression maximale en aspiration (*) Pressione massima in aspirazione (*)	Dynamic momentum J Momentum dynamique J Momento dinamico J	
		With cast iron impellers Avec roues en fonte Con giranti in ghisa	With AISI 316 impellers Avec roues en AISI 316 Con giranti in AISI 316
		$J = \frac{1}{4}PD^2$	
	[bar]	[kgm ²]	
NC32-250	0	0,04321	(F) 0,04731

(*) Value referred to the impeller with maximum diameter.

(*) Valeur se référant à la roue à ailettes avec le diamètre maximum.

(*) Valore riferito alla girante con diametro massimo

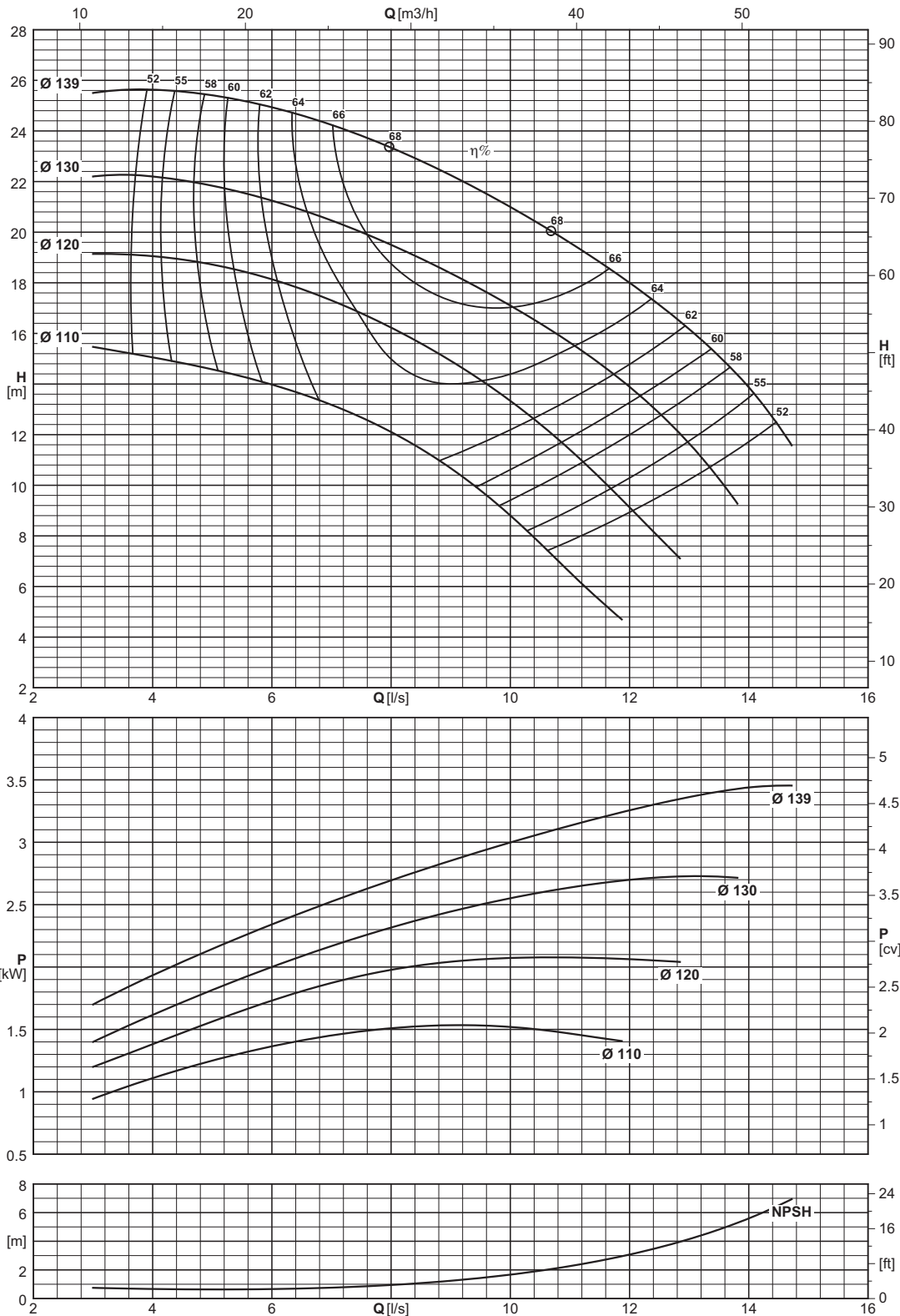

Type Type Tipo	Inlet maximum pressure (*) Pression maximale en aspiration (*) Pressione massima in aspirazione (*)	Dinamic momentum J Momentum dynamique J Momento dinamico J	
		With cast iron impellers Avec roues en fonte Con giranti in ghisa	With AISI 316 impellers Avec roues en AISI 316 Con giranti in AISI 316
		J=1/4PD²	
	[bar]	[kgm²]	[kgm²]
NC40-125	6	0,00429	(F) 0,01104

Construction reference standard EN733 (DIN24255)
(*) Value referred to the impeller with maximum diameter.

Norme de référence construction EN733 (DIN24255)
(*) Valeur se référant à la roue à ailettes avec le diamètre maximum.

Norma di riferimento costruttivo EN733 (DIN24255)
(*) Valore riferito alla girante con diametro massimo

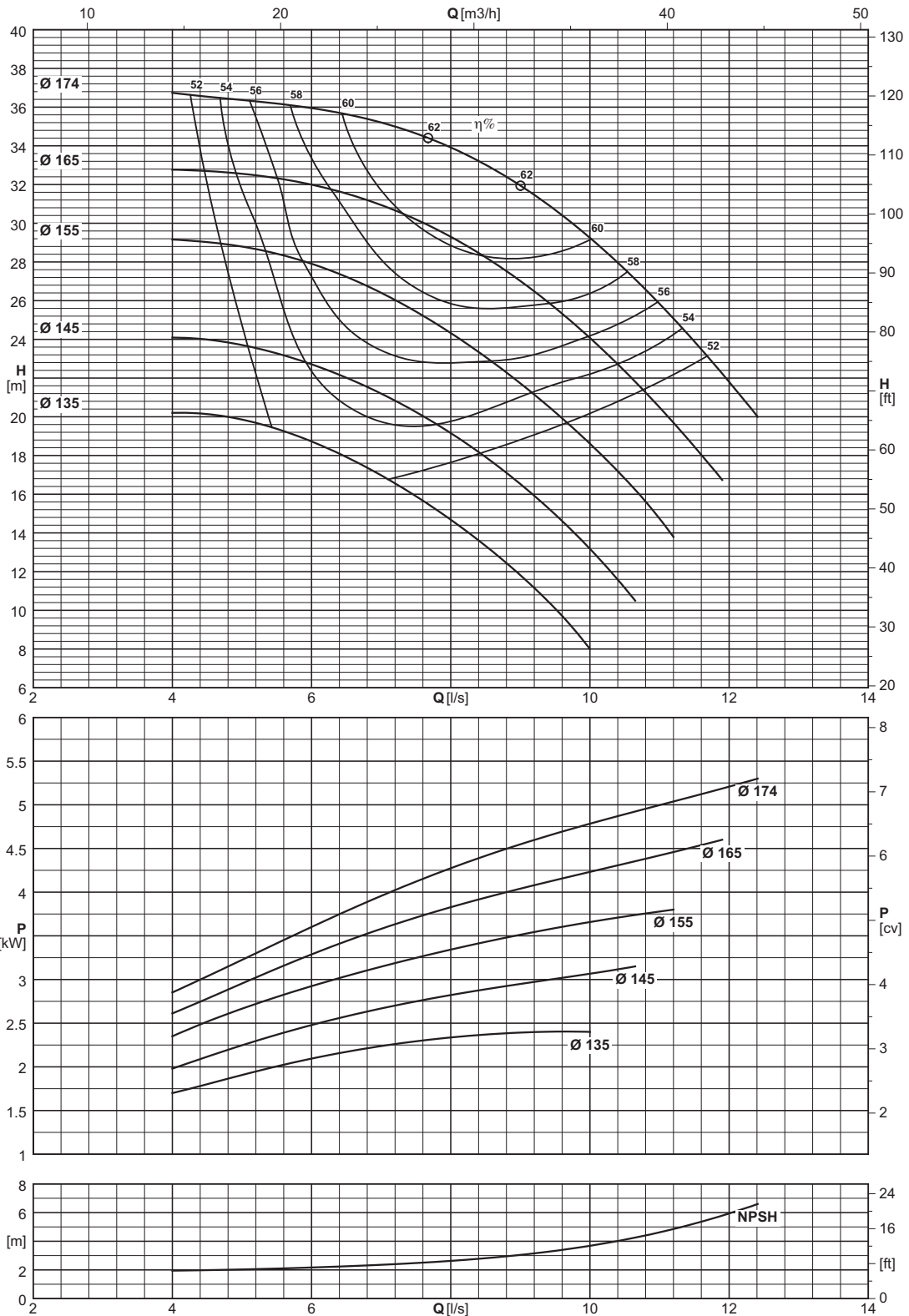

Type Type Tipo	Inlet maximum pressure (*) Pression maximale en aspiration (*) Pressione massima in aspirazione (*)	Dynamic momentum J Momentum dynamique J Momento dinamico J	
		With cast iron impellers Avec roues en fonte Con giranti in ghisa	With AISI 316 impellers Avec roues en AISI 316 Con giranti in AISI 316
		J=1/4PD²	
	[bar]	[kgm²]	[kgm²]
NC40-160	5	0,01104	(F) 0,01209

Construction reference standard EN733 (DIN24255)
 (*) Value referred to the impeller with maximum diameter.

Norme de référence construction EN733 (DIN24255)
 (*) Valeur se référant à la roue à ailettes avec le diamètre maximum.

Norma di riferimento costruttivo EN733 (DIN24255)
 (*) Valore riferito alla girante con diametro massimo

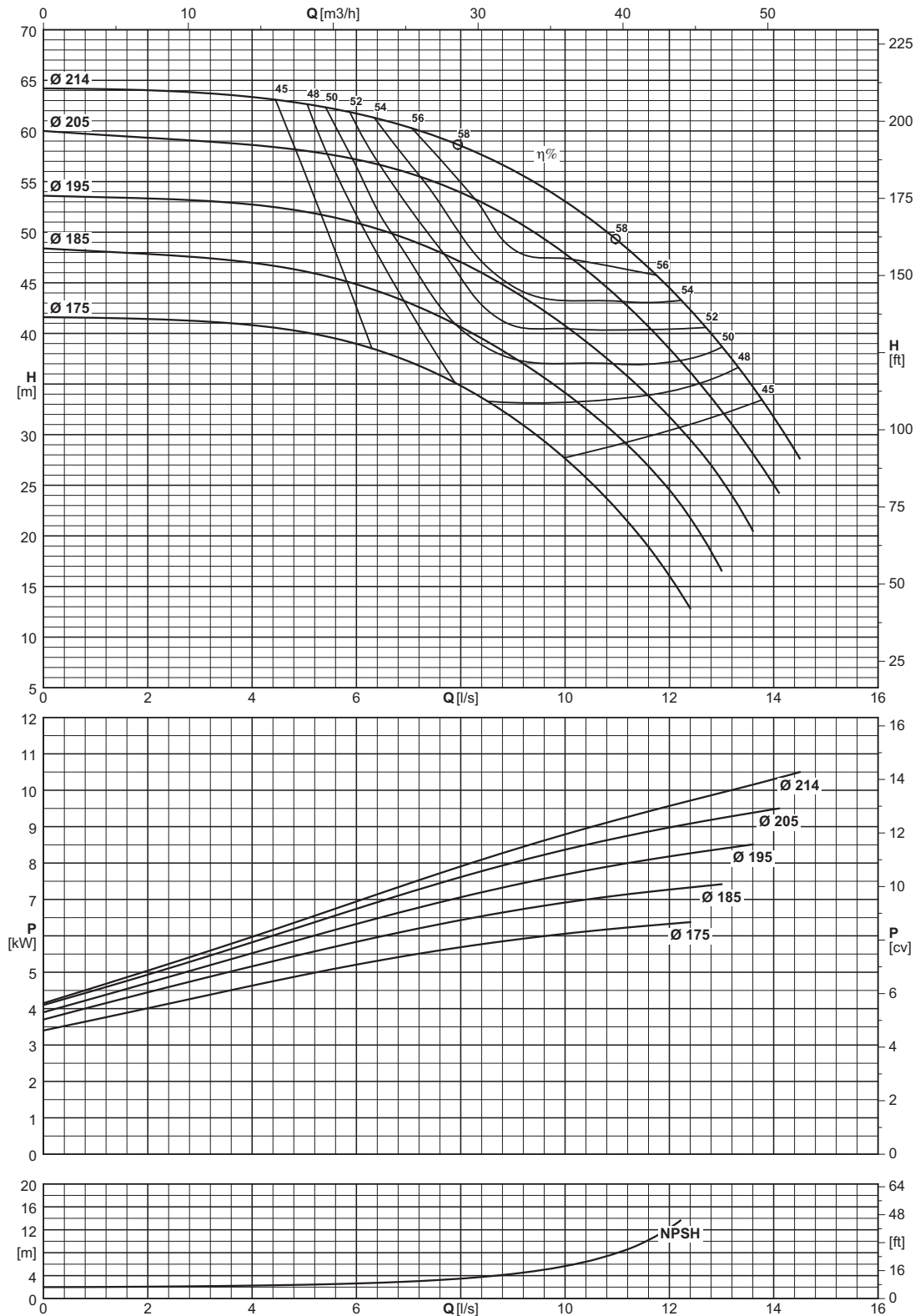

Type Type Tipo	Inlet maximum pressure (*) Pression maximale en aspiration (*) Pressione massima in aspirazione (*)	Dynamic momentum J Momentum dynamique J Momento dinamico J	
		With cast iron impellers Avec roues en fonte Con giranti in ghisa	With AISI 316 impellers Avec roues en AISI 316 Con giranti in AISI 316
		J=1/2*PD²	
[bar]		[kgm²]	
NC40-200	2	0,02742	(F) 0,03002

Construction reference standard EN733 (DIN24255)
(*) Value referred to the impeller with maximum diameter.

Norme de référence construction EN733 (DIN24255)
(*) Valeur se référant à la roue à ailettes avec le diamètre maximum.

Norma di riferimento costruttivo EN733 (DIN24255)
(*) Valore riferito alla girante con diametro massimo

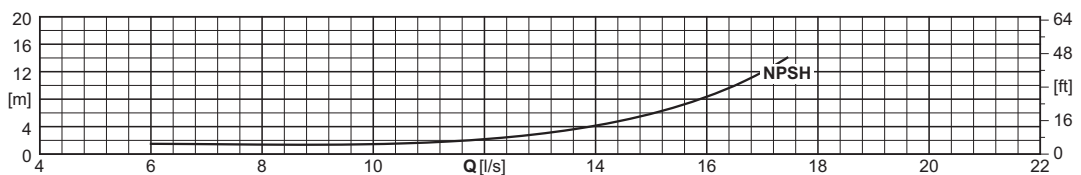
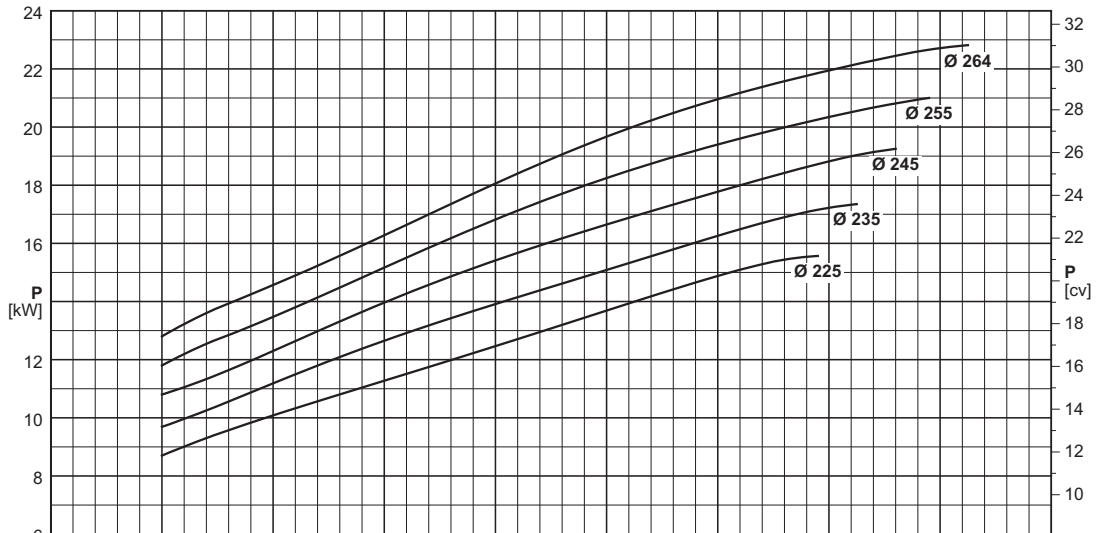
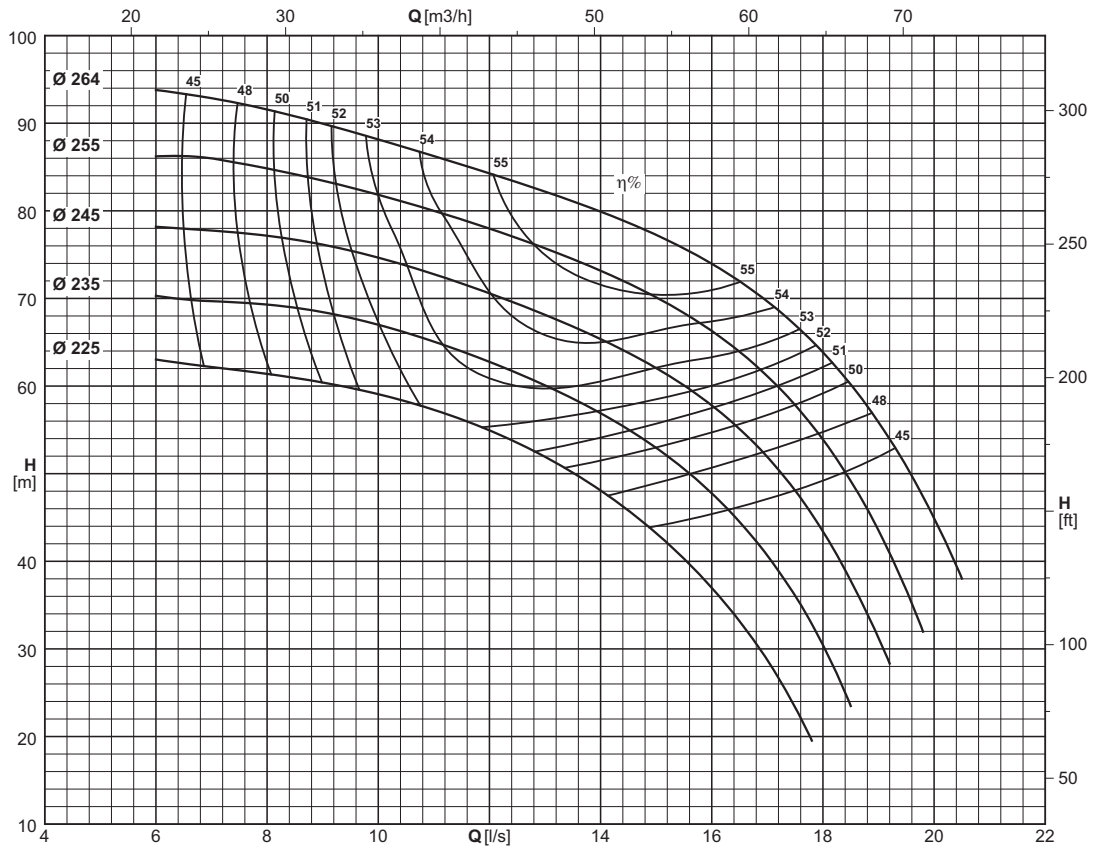

Type Type Tipo	Inlet maximum pressure (*) Pression maximale en aspiration (*) Pressione massima in aspirazione (*)	Dynamic momentum J Momentum dynamique J Momento dinamico J	
		With cast iron impellers Avec roues en fonte Con giranti in ghisa	With AISI 316 impellers Avec roues en AISI 316 Con giranti in AISI 316
		J=1/4PD ²	
[bar]		[kgm ²]	
NC40-250	0	0,04818	(F) 0,05276

Construction reference standard EN733 (DIN24255)
 (*) Value referred to the impeller with maximum diameter.

Norme de référence construction EN733 (DIN24255)
 (*) Valeur se référant à la roue à ailettes avec le diamètre maximum.

Norma di riferimento costruttivo EN733 (DIN24255)
 (*) Valore riferito alla girante con diametro massimo

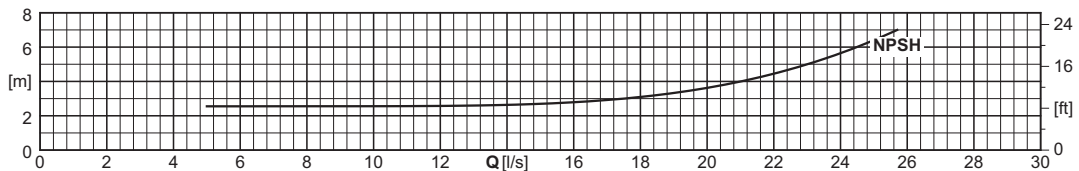
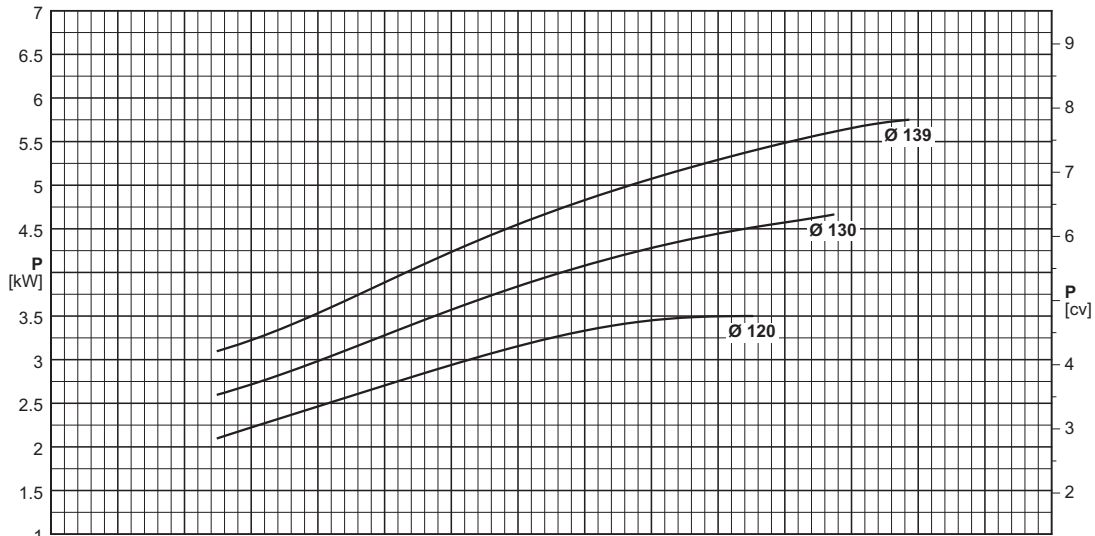
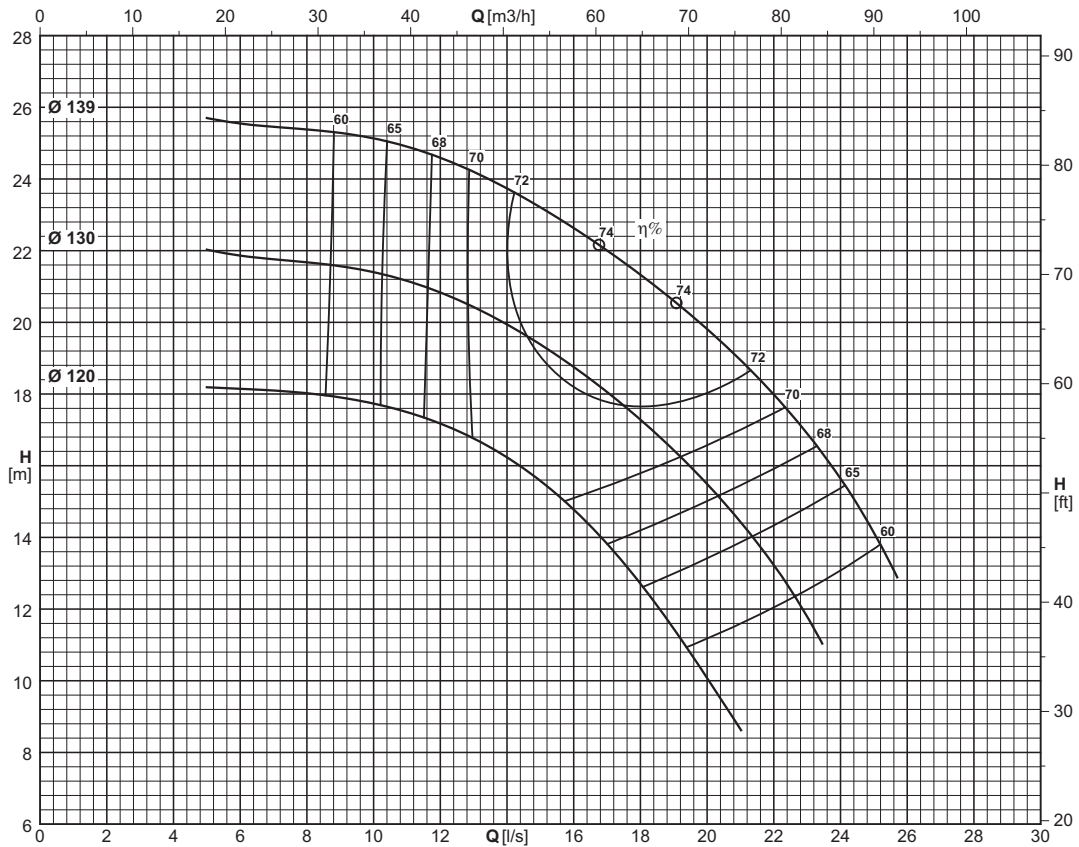

Type Type Tipo	Inlet maximum pressure (*) Pression maximale en aspiration (*) Pressione massima in aspirazione (*)	Dinamic momentum J Momentum dynamique J Momento dinamico J	
		With cast iron impellers Avec roues en fonte Con giranti in ghisa	With AISI 316 impellers Avec roues en AISI 316 Con giranti in AISI 316
		J=1/4PD²	
	[bar]	[kgm²]	[kgm²]
NC50-125	6	0,00495	(F) 0,00542

Construction reference standard EN733 (DIN24255)
 (*) Value referred to the impeller with maximum diameter.

Norme de référence construction EN733 (DIN24255)
 (*) Valeur se référant à la roue à ailettes avec le diamètre maximum.

Norma di riferimento costruttivo EN733 (DIN24255)
 (*) Valore riferito alla girante con diametro massimo

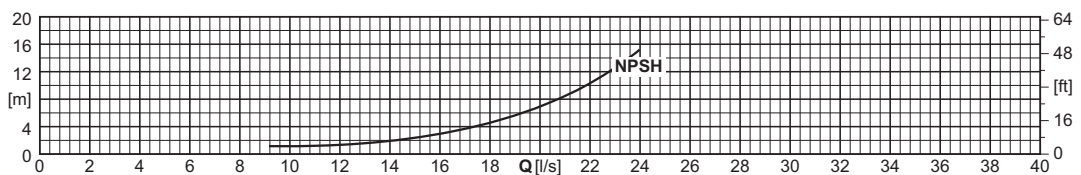
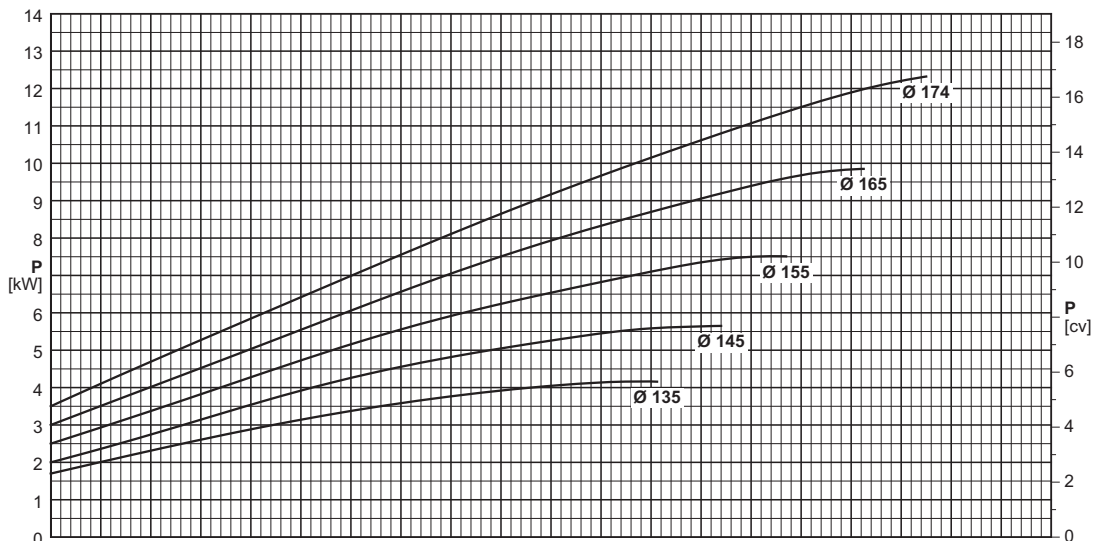
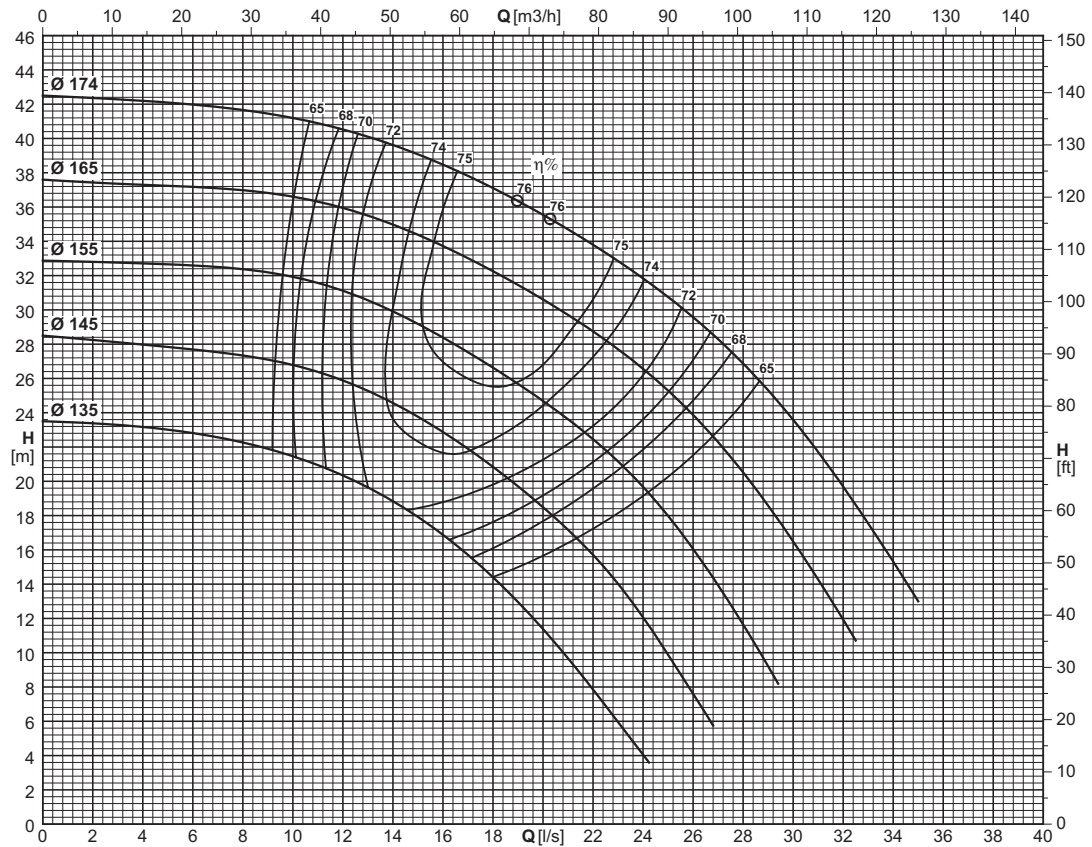

Type Type Tipo	Inlet maximum pressure (*) Pression maximale en aspiration (*) Pressione massima in aspirazione (*)	Dynamic momentum J Momentum dynamique J Momento dinamico J	
		With cast iron impellers Avec roues en fonte Con giranti in ghisa	With AISI 316 impellers Avec roues en AISI 316 Con giranti in AISI 316
		$J = \frac{1}{4}PD^2$	
	[bar]	[kgm ²]	
NC50-160	4	0,01193	(F) 0,01307

Construction reference standard EN733 (DIN24255)
(*) Value referred to the impeller with maximum diameter.

Norme de référence construction EN733 (DIN24255)
(*) Valeur se référant à la roue à ailettes avec le diamètre maximum.

Norma di riferimento costruttivo EN733 (DIN24255)
(*) Valore riferito alla girante con diametro massimo

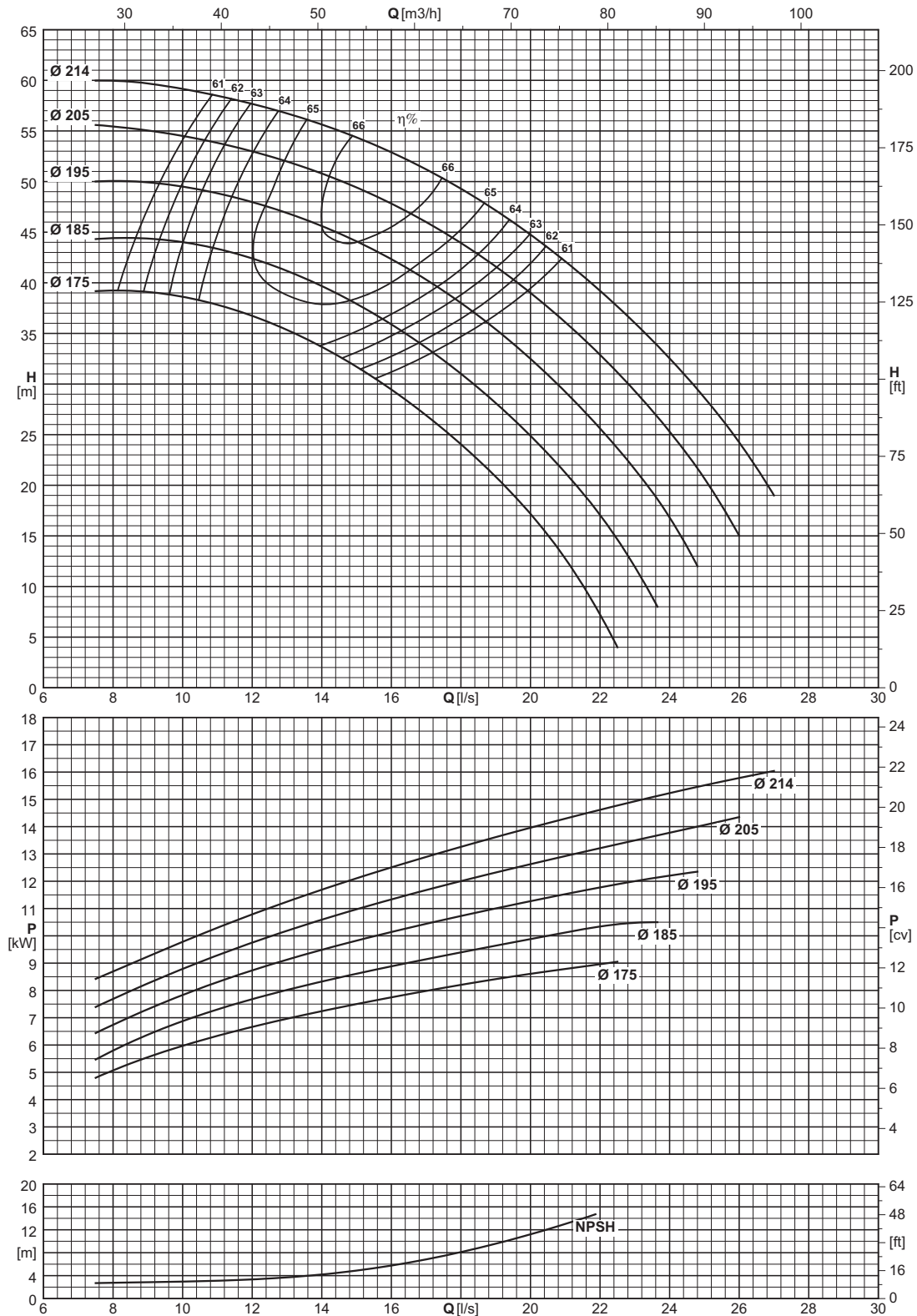

Type Type Tipo	Inlet maximum pressure (*) Pression maximale en aspiration (*) Pressione massima in aspirazione (*)	Dynamic momentum J Momentum dynamique J Momento dinamico J	
		With cast iron impellers Avec roues en fonte Con giranti in ghisa	With AISI 316 impellers Avec roues en AISI 316 Con giranti in AISI 316
		J=1/4 PD ²	
	[bar]	[kgm ²]	
NC50-200	2	0,02742	(F) 0,03002

Construction reference standard EN733 (DIN24255)
(*) Value referred to the impeller with maximum diameter.

Norme de référence construction EN733 (DIN24255)
(*) Valeur se référant à la roue à ailettes avec le diamètre maximum.

Norma di riferimento costruttivo EN733 (DIN24255)
(*) Valore riferito alla girante con diametro massimo

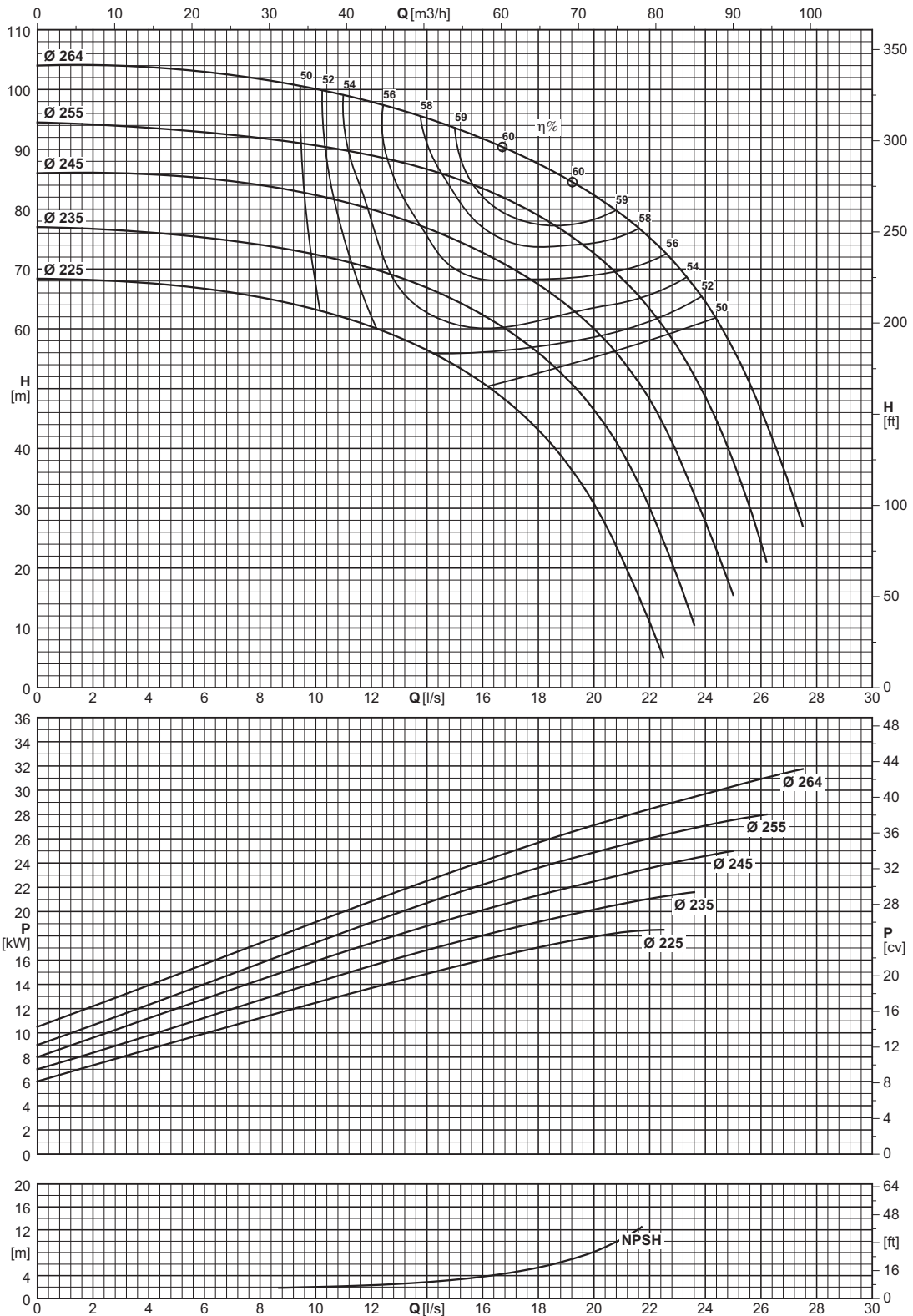

Type Type Tipo	Inlet maximum pressure (*) Pression maximale en aspiration (*) Pressione massima in aspirazione (*)	Dynamic momentum J Momentum dynamique J Momento dinamico J	
		With cast iron impellers Avec roues en fonte Con giranti in ghisa	With AISI 316 impellers Avec roues en AISI 316 Con giranti in AISI 316
		$J = \frac{1}{4}PD^2$	
	[bar]	[kgm ²]	
NC50-250	0	0,05553	(F) 0,06081

Construction reference standard EN733 (DIN24255)
(*) Value referred to the impeller with maximum diameter.

Norme de référence construction EN733 (DIN24255)
(*) Valeur se référant à la roue à ailettes avec le diamètre maximum.

Norma di riferimento costruttivo EN733 (DIN24255)
(*) Valore riferito alla girante con diametro massimo

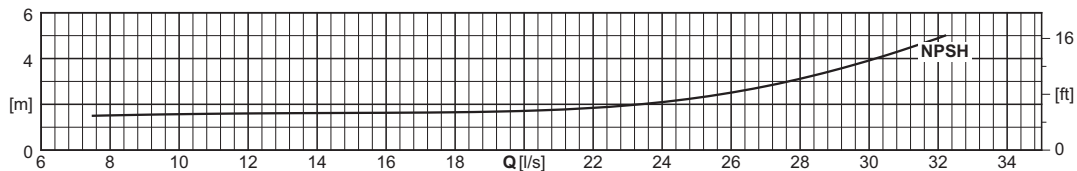
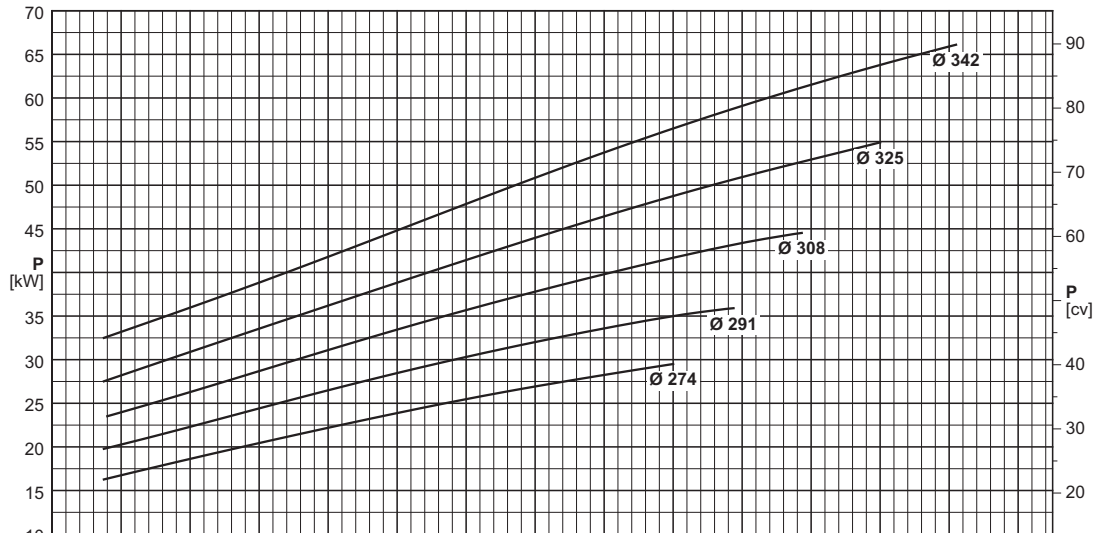
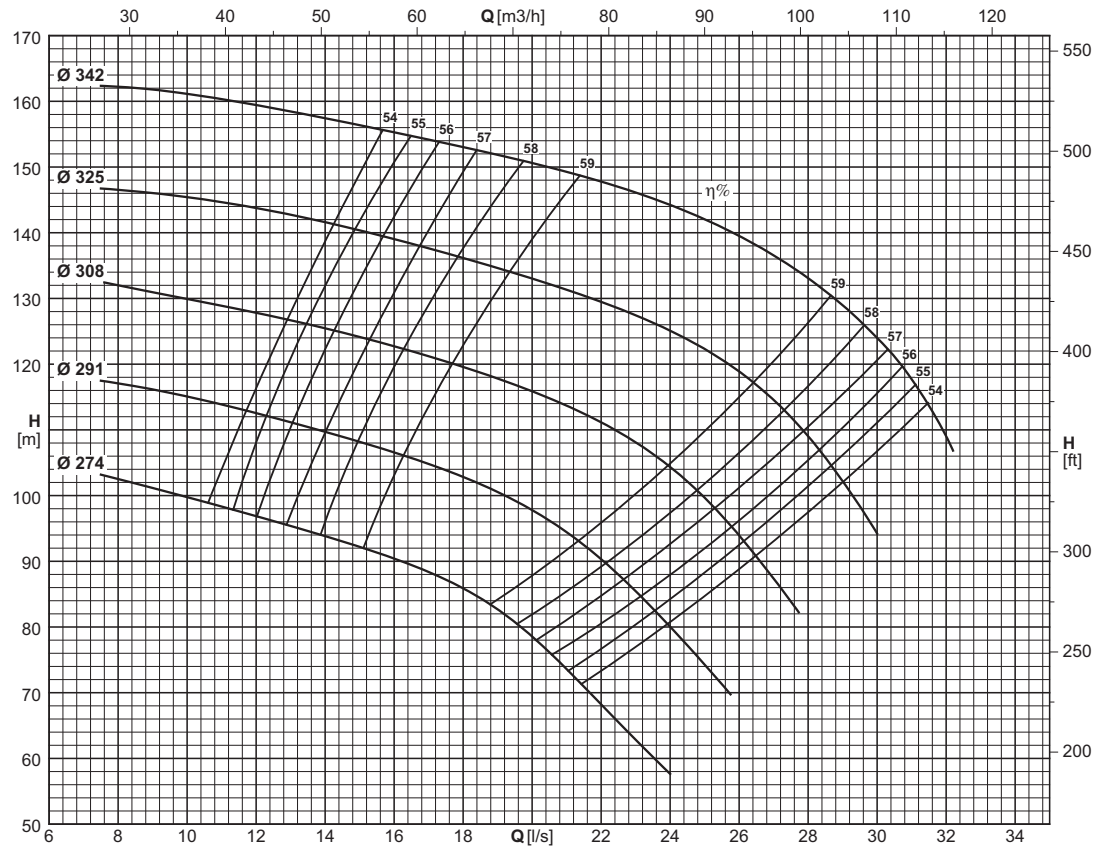

Type Type Tipo	Inlet maximum pressure (*) Pression maximale en aspiration (*) Pressione massima in aspirazione (*)	Dynamic momentum J Momentum dynamique J Momento dinamico J	
		With cast iron impellers Avec roues en fonte Con giranti in ghisa	With AISI 316 impellers Avec roues en AISI 316 Con giranti in AISI 316
		J = 1/4 PD ²	
	[bar]	[kgm ²]	
NCH50-315	8	0,25640	(F) 0,27779

(*) Value referred to the impeller with maximum diameter.

(*) Valeur se référant à la roue à ailettes avec le diamètre maximum.

(*) Valore riferito alla girante con diametro massimo

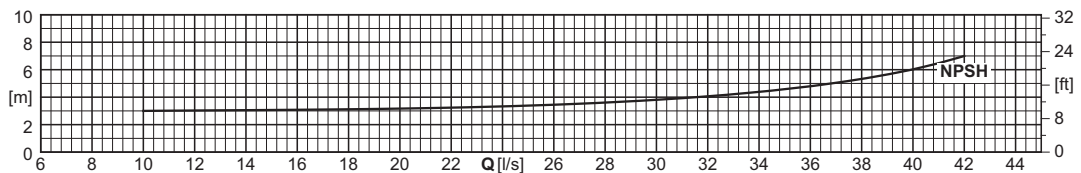
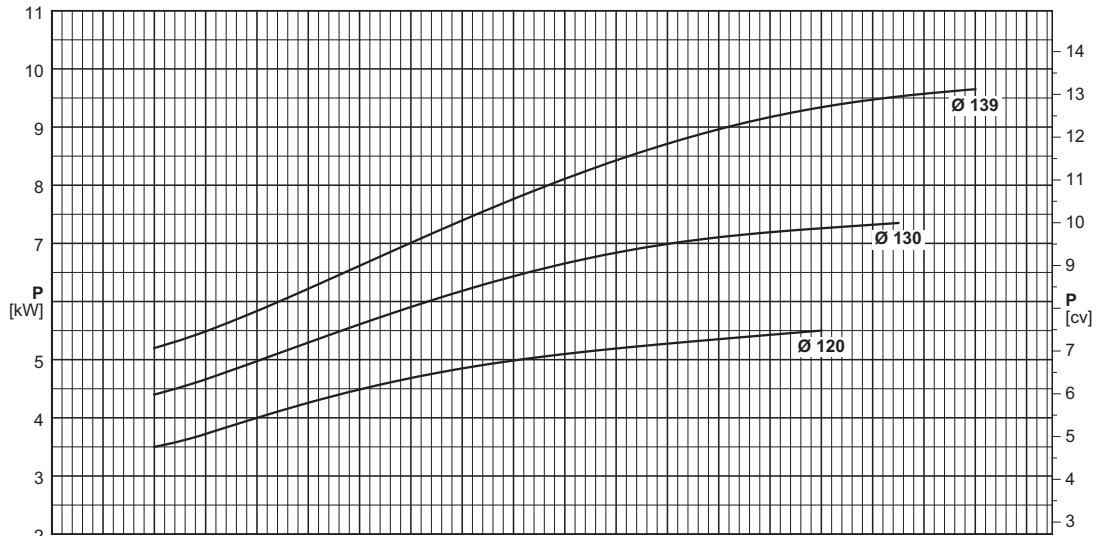
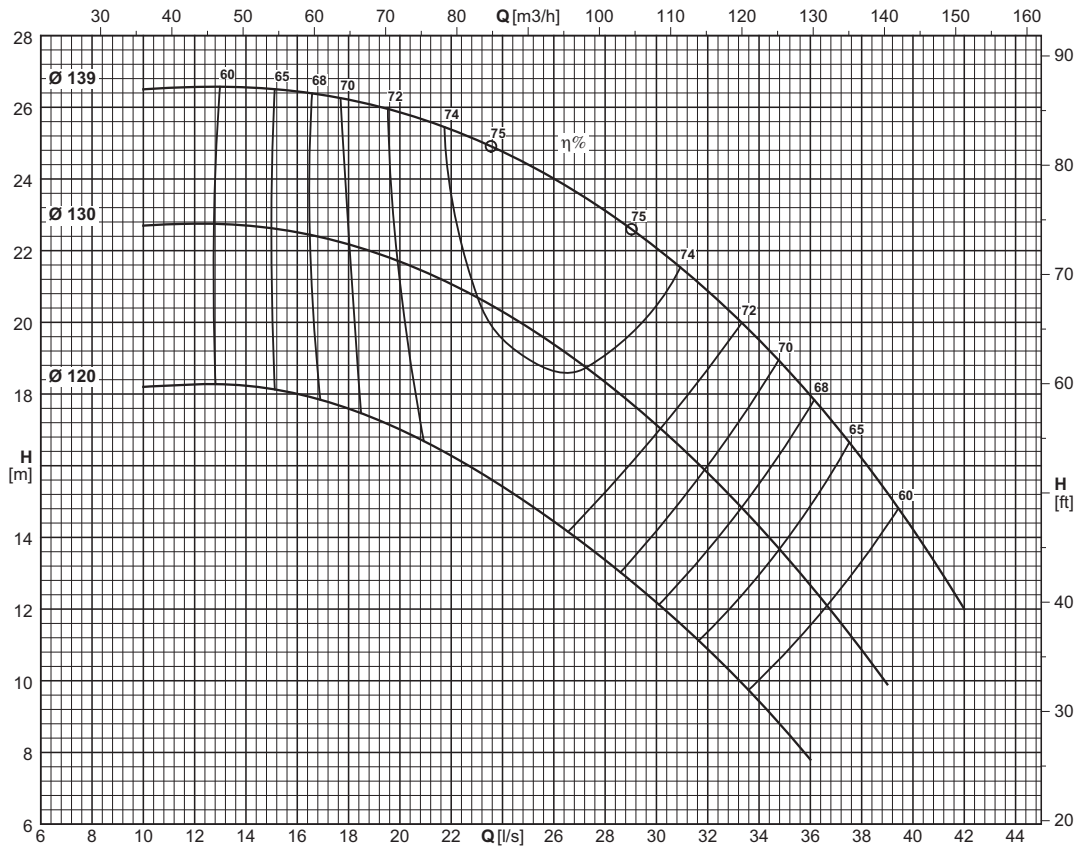

Type Type Tipo	Inlet maximum pressure (*) Pression maximale en aspiration (*) Pressione massima in aspirazione (*)	Dynamic momentum J Momentum dynamique J Momento dinamico J	
		With cast iron impellers Avec roues en fonte Con giranti in ghisa	With AISI 316 impellers Avec roues en AISI 316 Con giranti in AISI 316
		J=1/4PD²	
	[bar]	[kgm²]	[kgm²]
NC65-125	6	0,00817	(F) 0,00895

Construction reference standard EN733 (DIN24255)
 (*) Value referred to the impeller with maximum diameter.

Norme de référence construction EN733 (DIN24255)
 (*) Valeur se référant à la roue à ailettes avec le diamètre maximum.

Norma di riferimento costruttivo EN733 (DIN24255)
 (*) Valore riferito alla girante con diametro massimo

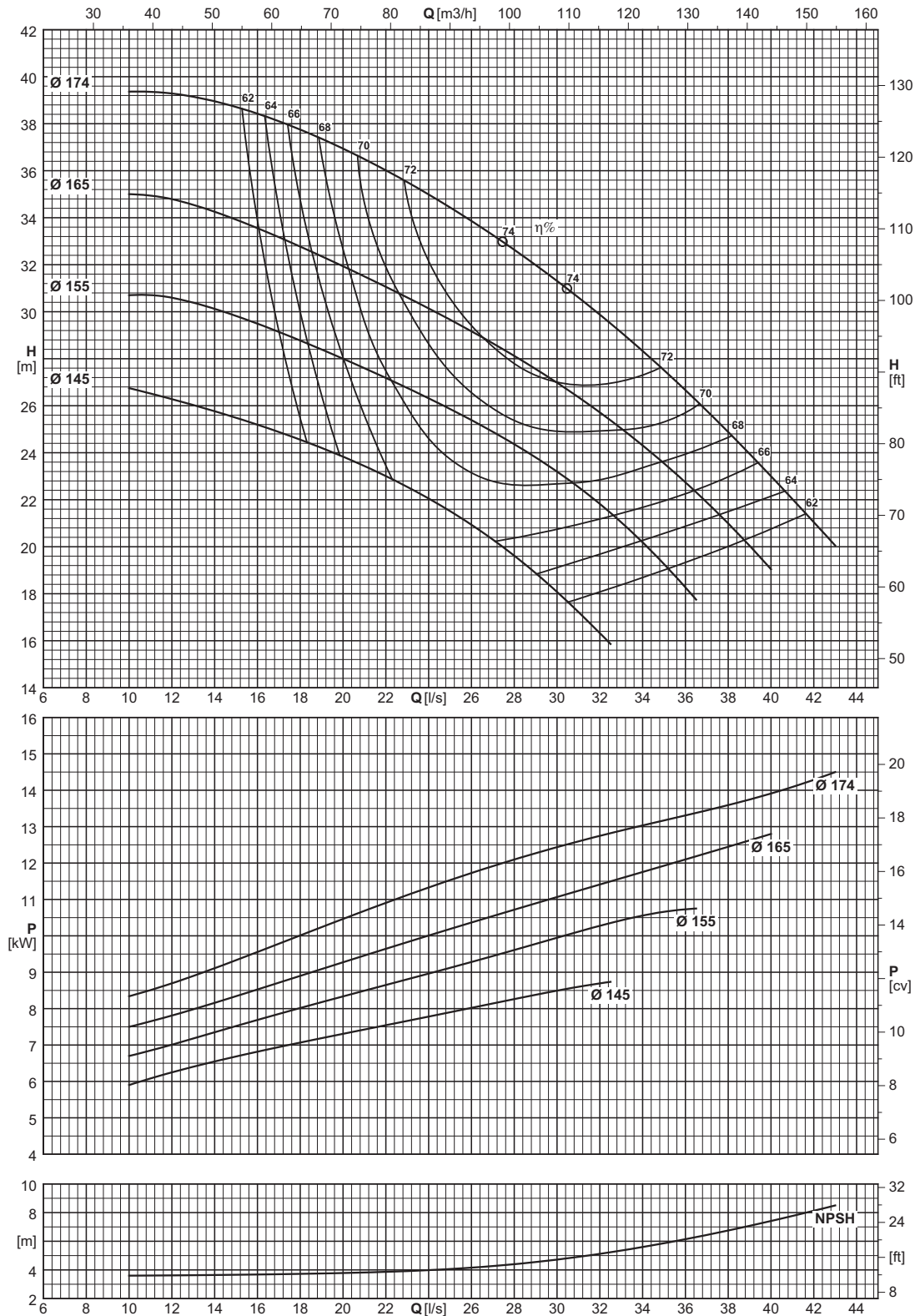

Type Type Tipo	Inlet maximum pressure (*) Pression maximale en aspiration (*) Pressione massima in aspirazione (*)	Dynamic momentum J Momentum dynamique J Momento dinamico J	
		With cast iron impellers Avec roues en fonte Con giranti in ghisa	With AISI 316 impellers Avec roues en AISI 316 Con giranti in AISI 316
		J = 1/4 PD²	
[bar]		[kgm²]	
NC65-160	5	0,01747	(F) 0,01913

Construction reference standard EN733 (DIN24255)
(*) Value referred to the impeller with maximum diameter.

Norme de référence construction EN733 (DIN24255)
(*) Valeur se référant à la roue à ailettes avec le diamètre maximum.

Norma di riferimento costruttivo EN733 (DIN24255)
(*) Valore riferito alla girante con diametro massimo

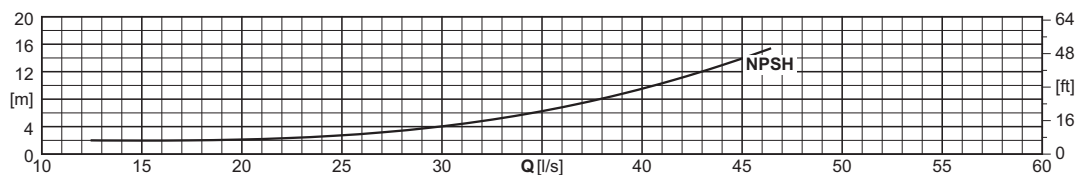
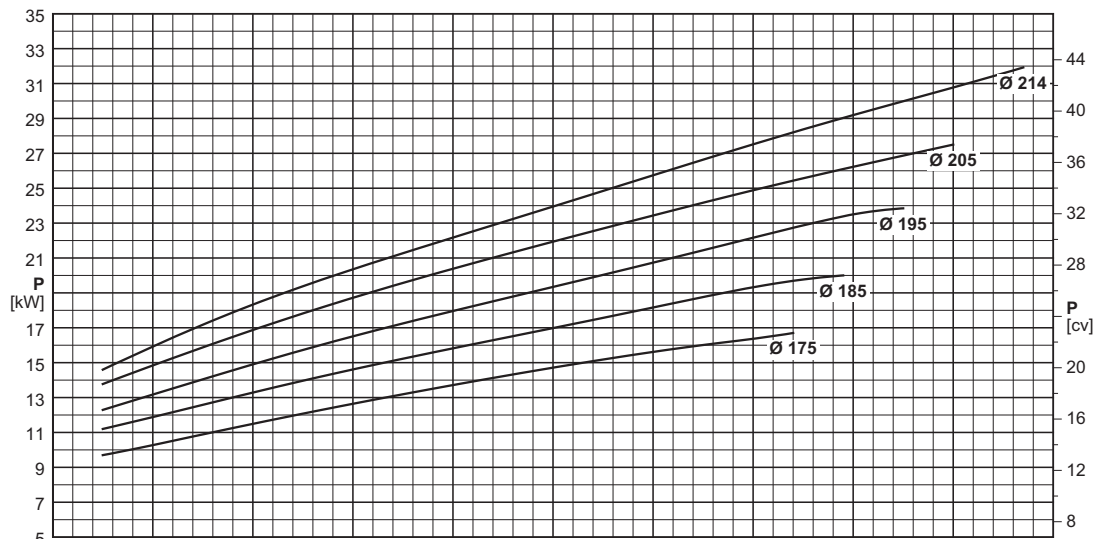
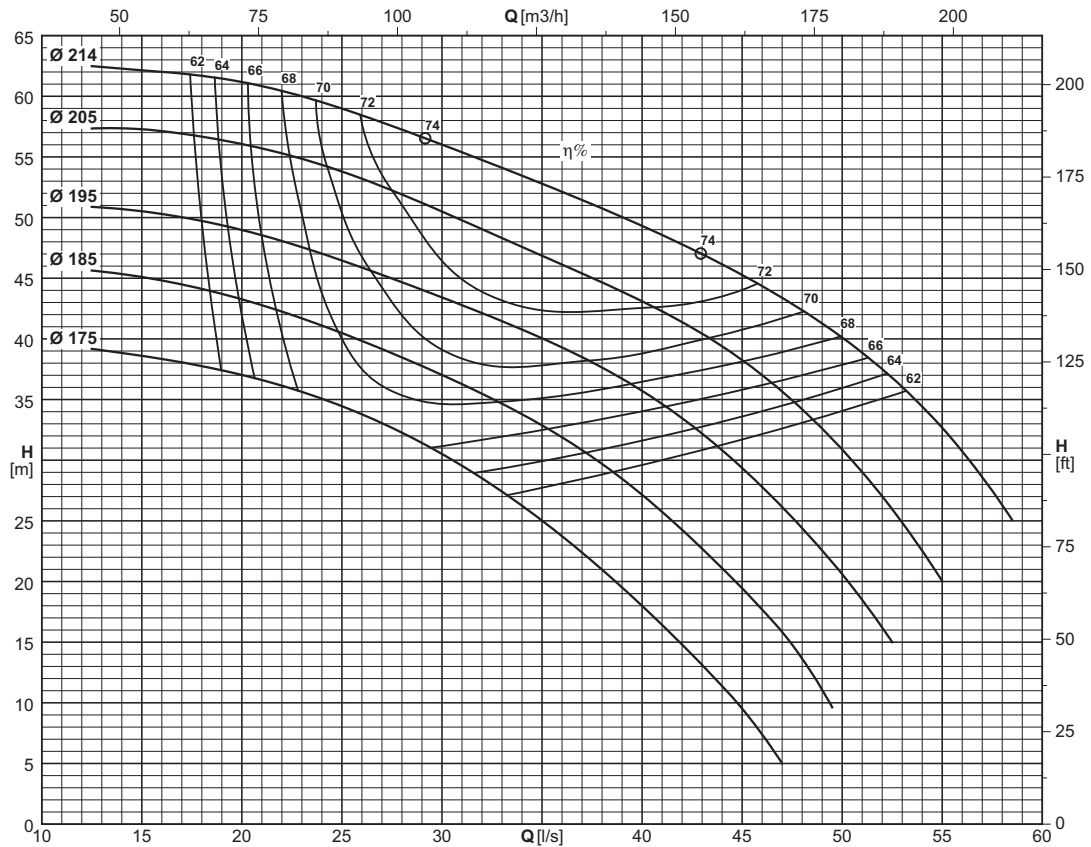

Type Type Tipo	Inlet maximum pressure (*) Pression maximale en aspiration (*) Pressione massima in aspirazione (*)	Dynamic momentum J Momentum dynamique J Momento dinamico J	
		With cast iron impellers Avec roues en fonte Con giranti in ghisa	With AISI 316 impellers Avec roues en AISI 316 Con giranti in AISI 316
		$J = \frac{1}{4}PD^2$	
	[bar]	[kgm ²]	
NC65-200	2	0,02938	(F) 0,03217

Construction reference standard EN733 (DIN24255)
(*) Value referred to the impeller with maximum diameter.

Norme de référence construction EN733 (DIN24255)
(*) Valeur se référant à la roue à ailettes avec le diamètre maximum.

Norma di riferimento costruttivo EN733 (DIN24255)
(*) Valore riferito alla girante con diametro massimo

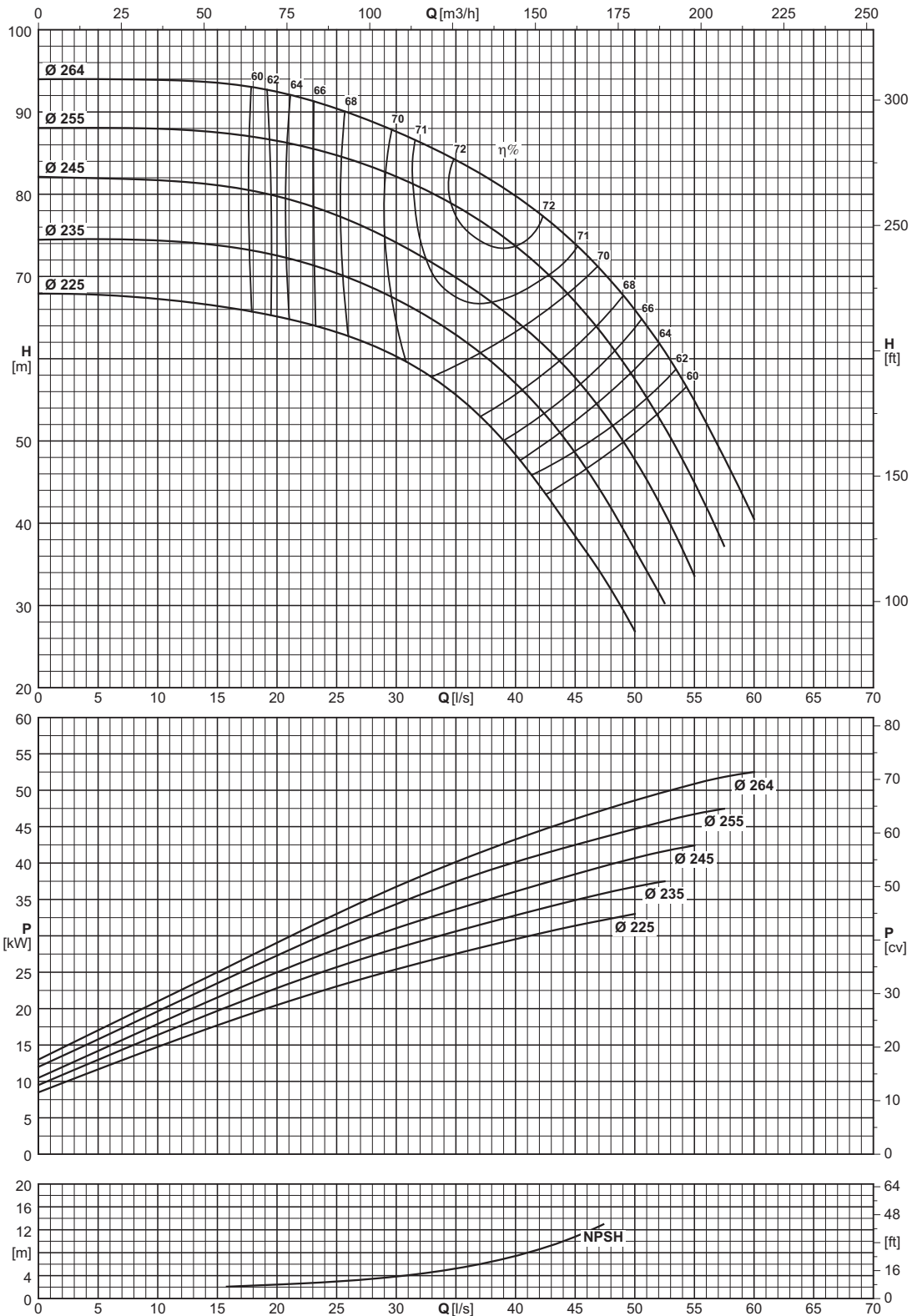

Type Type Tipo	Inlet maximum pressure (*) Pression maximale en aspiration (*) Pressione massima in aspirazione (*)	Dynamic momentum J Momentum dynamique J Momento dinamico J	
		With cast iron impellers Avec roues en fonte Con giranti in ghisa	With AISI 316 impellers Avec roues en AISI 316 Con giranti in AISI 316
		J = 1/4 PD ²	
[bar]		[kgm ²]	
NC65-250	0	0,06090	(F) 0,06668

Construction reference standard EN733 (DIN24255)
(*) Value referred to the impeller with maximum diameter.

Norme de référence construction EN733 (DIN24255)
(*) Valeur se référant à la roue à ailettes avec le diamètre maximum.

Norma di riferimento costruttivo EN733 (DIN24255)
(*) Valore riferito alla girante con diametro massimo

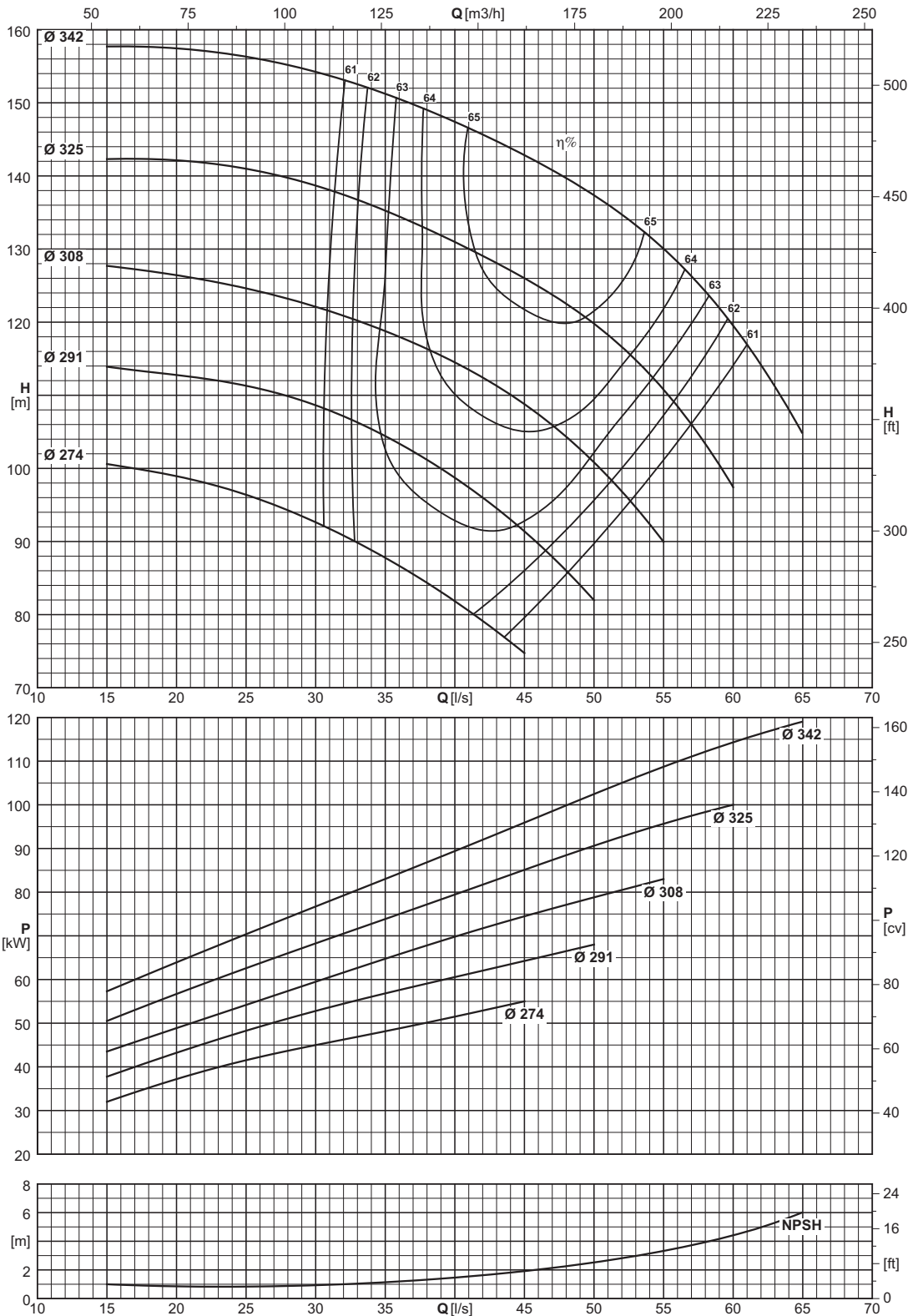

Type Type Tipo	Inlet maximum pressure (*) Pression maximale en aspiration (*) Pressione massima in aspirazione (*)	Dynamic momentum J Momentum dynamique J Momento dinamico J	
		With cast iron impellers Avec roues en fonte Con giranti in ghisa	With AISI 316 impellers Avec roues en AISI 316 Con giranti in AISI 316
		J=1/4PD²	
	[bar]	[kgm²]	[kgm²]
NCH65-315	0	0,21925	(F) 0,23752

(*) Value referred to the impeller with maximum diameter.

(*) Valeur se référant à la roue à ailettes avec le diamètre maximum.

(*) Valore riferito alla girante con diametro massimo

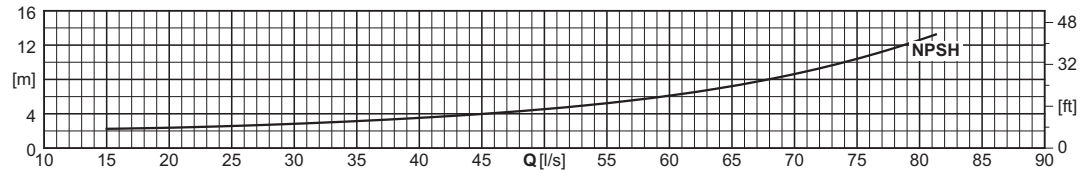
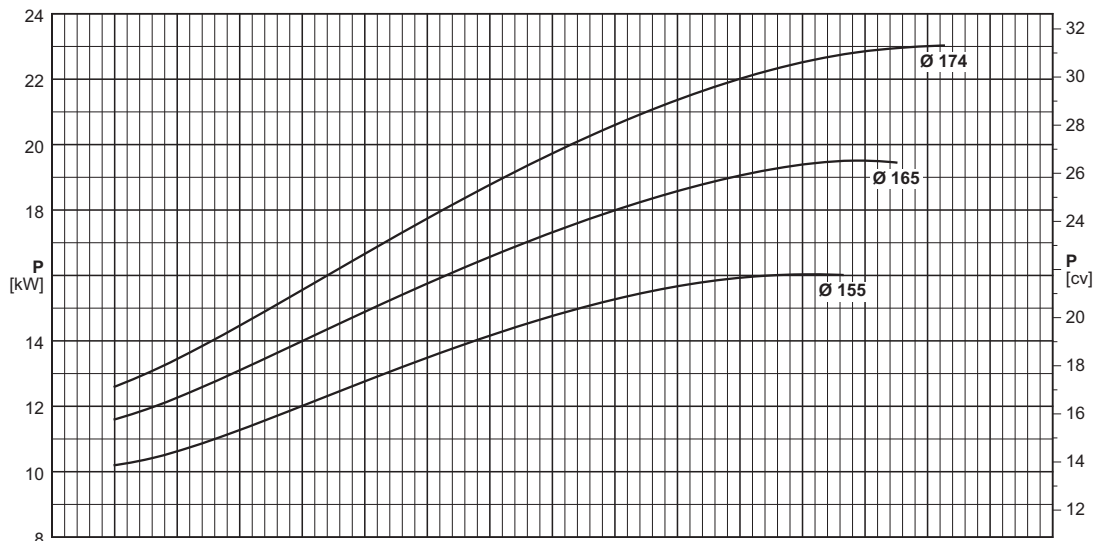
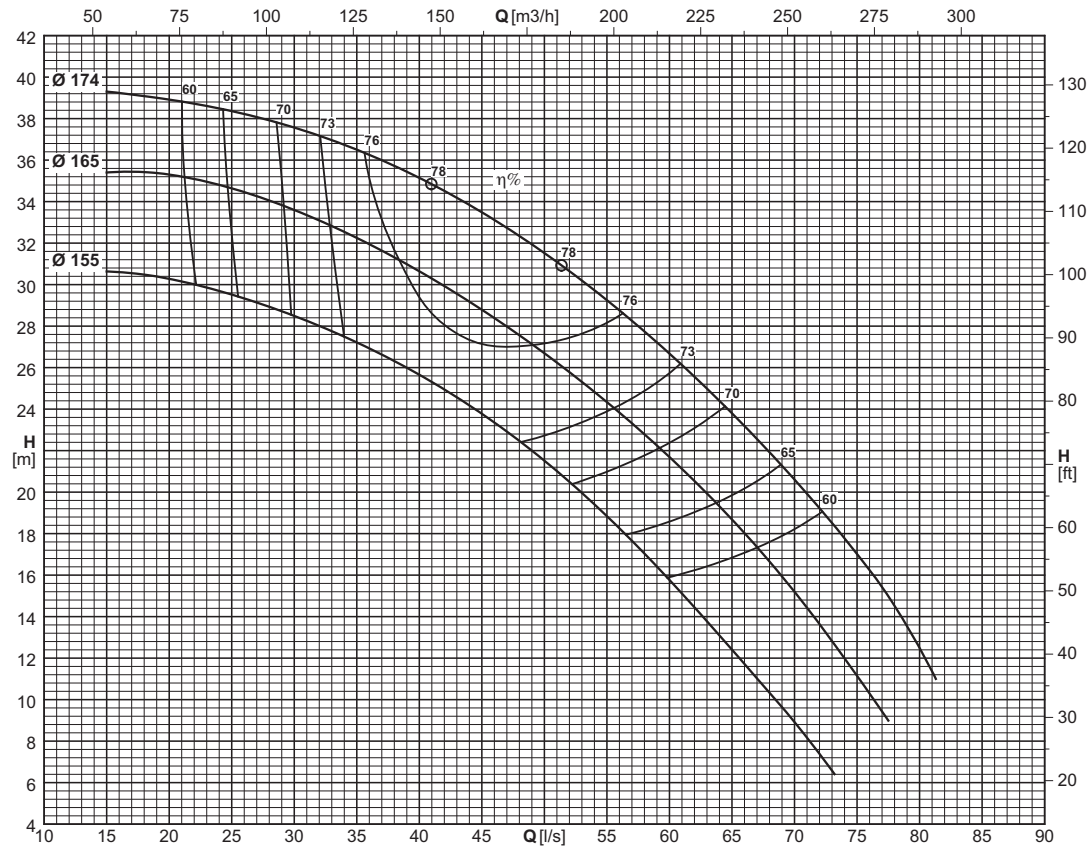

Type Type Tipo	Inlet maximum pressure (*) Pression maximale en aspiration (*) Pressione massima in aspirazione (*)	Dinamic momentum J Momentum dynamique J Momento dinamico J	
		With cast iron impellers Avec roues en fonte Con giranti in ghisa	With AISI 316 impellers Avec roues en AISI 316 Con giranti in AISI 316
		J=1/4PD²	
[bar]		[kgm²]	
NC80-160	5	0,01982	(F) 0,02170

Construction reference standard EN733 (DIN24255) Norme de référence construction EN733 (DIN24255) Norma di riferimento costruttivo EN733 (DIN24255)
 (*) Value referred to the impeller with maximum diameter. (*) Valeur se référant à la roue à ailettes avec le diamètre maximum. (*) Valore riferito alla girante con diametro massimo

Operating data
 Caracteristiques de fonctionnement
 Caratteristiche di funzionamento

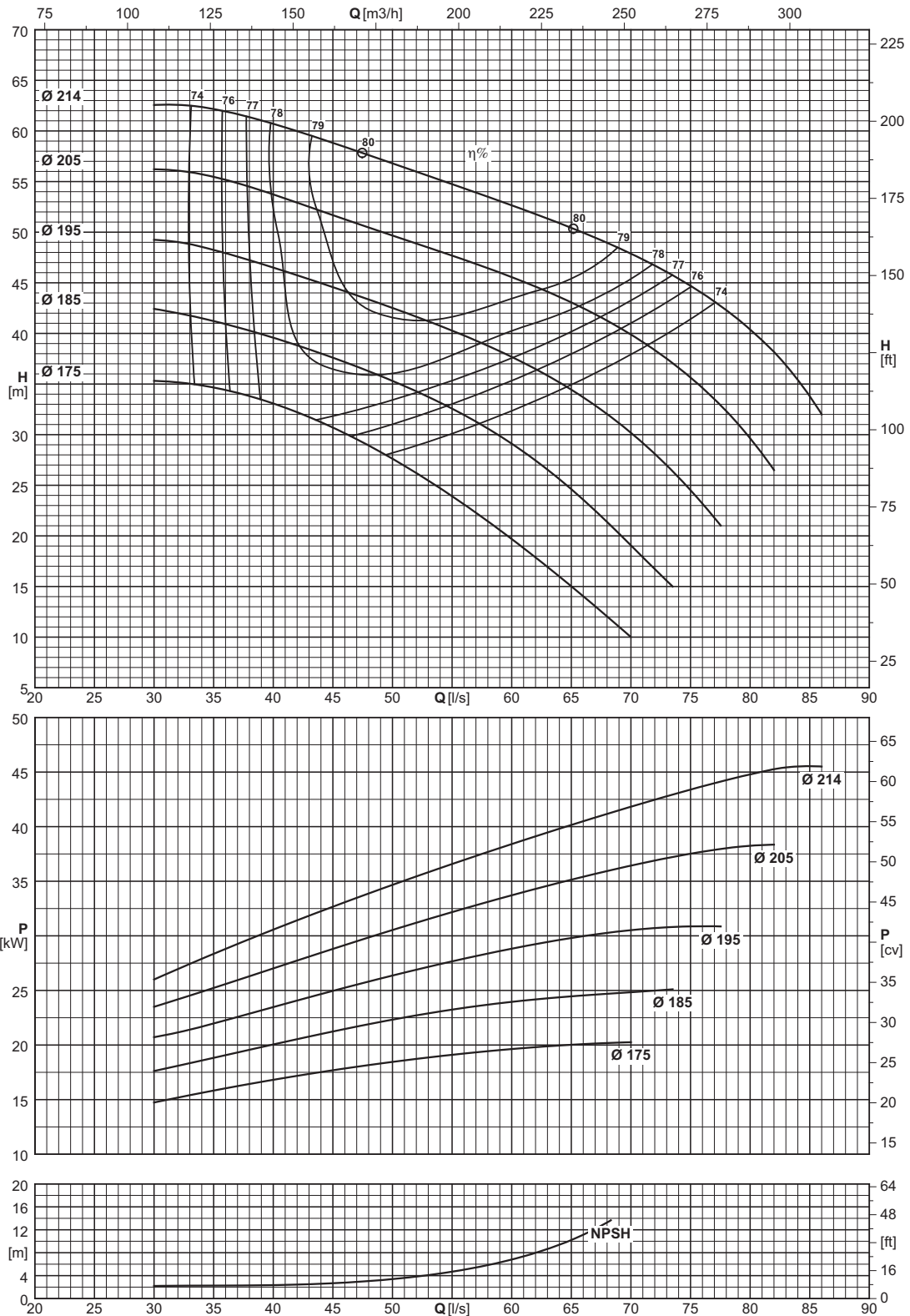

Type Type Tipo	Inlet maximum pressure (*) Pression maximale en aspiration (*) Pressione massima in aspirazione (*)	Dinamic momentum J Momentum dynamique J Momento dinamico J	
		With cast iron impellers Avec roues en fonte Con giranti in ghisa	With AISI 316 impellers Avec roues en AISI 316 Con giranti in AISI 316
		J=1/4PD²	
[bar]		[kgm²]	
NC80-200	2	0,04348	(F) 0,04761

Construction reference standard EN733 (DIN24255)
 (*) Value referred to the impeller with maximum diameter.

Norme de référence construction EN733 (DIN24255)
 (*) Valeur se référant à la roue à ailettes avec le diamètre maximum.

Norma di riferimento costruttivo EN733 (DIN24255)
 (*) Valore riferito alla girante con diametro massimo

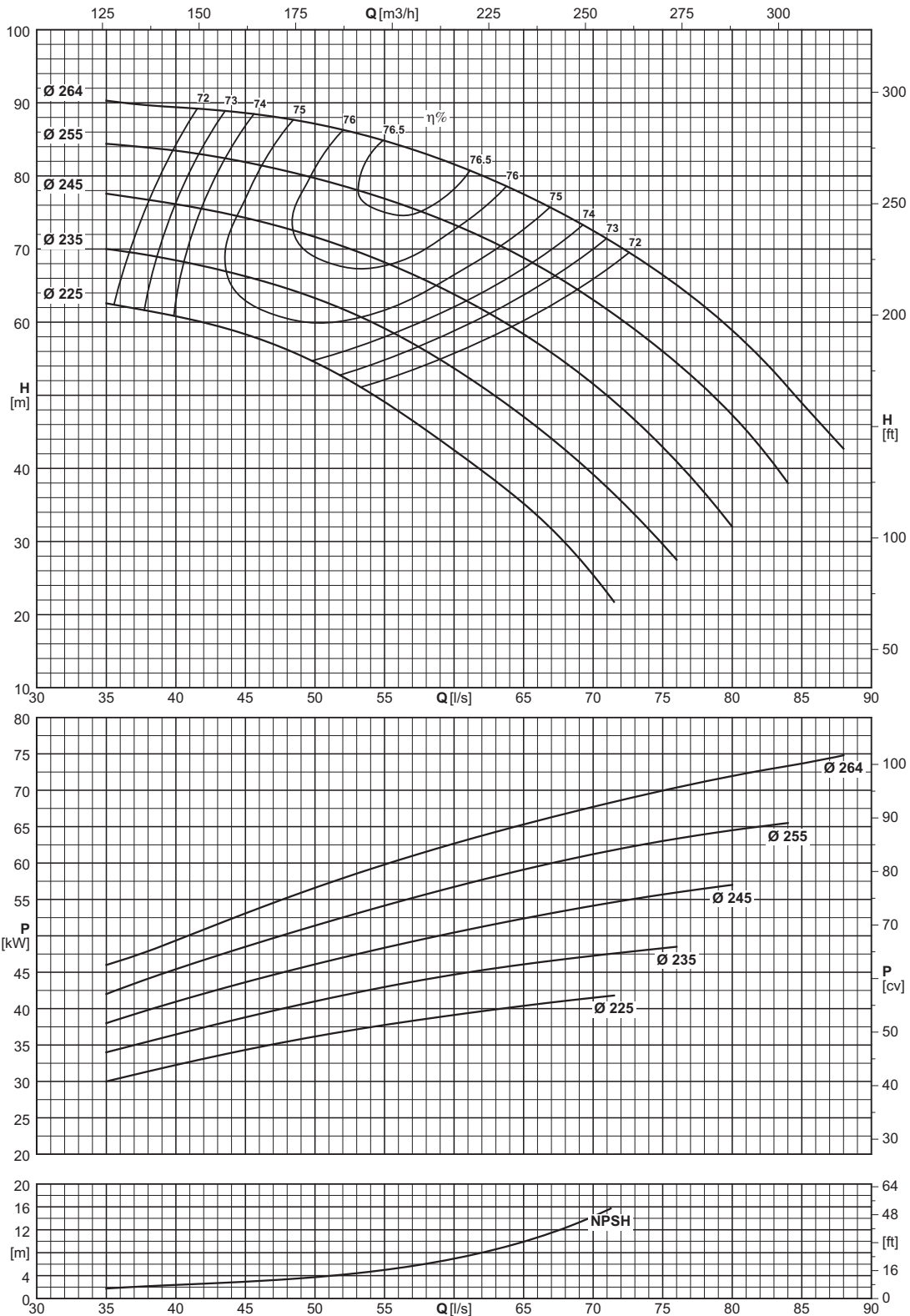

Type Type Tipo	Inlet maximum pressure (*) Pression maximale en aspiration (*) Pressione massima in aspirazione (*)	Dinamic momentum J Momentum dynamique J Momento dinamico J	
		With cast iron impellers Avec roues en fonte Con giranti in ghisa	With AISI 316 impellers Avec roues en AISI 316 Con giranti in AISI 316
		J = 1/4 PD ²	
	[bar]	[kgm ²]	[kgm ²]
NC80-250	0	0,07294	(F) 0,07987

Construction reference standard EN733 (DIN24255)
(*) Value referred to the impeller with maximum diameter.

Norme de référence construction EN733 (DIN24255)
(*) Valeur se référant à la roue à ailettes avec le diamètre maximum.

Norma di riferimento costruttivo EN733 (DIN24255)
(*) Valore riferito alla girante con diametro massimo

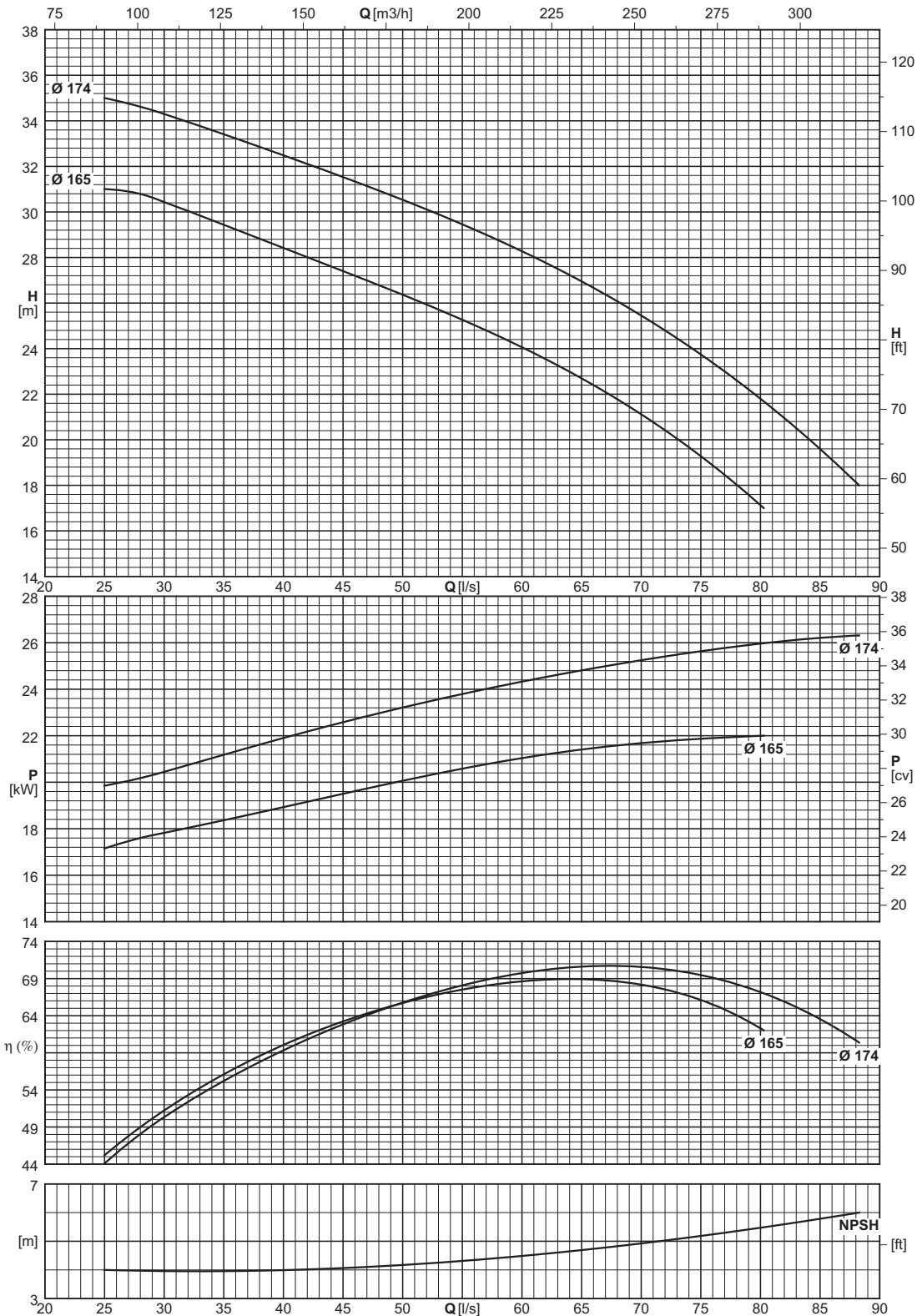

Type Type Tipo	Inlet maximum pressure (*) Pression maximale en aspiration (*) Pressione massima in aspirazione (*)	Dinamic momentum J Momentum dynamique J Momento dinamico J	
		With cast iron impellers Avec roues en fonte Con giranti in ghisa	With AISI 316 impellers Avec roues en AISI 316 Con giranti in AISI 316
		J=1/4PD²	
	[bar]	[kgm²]	[kgm²]
NC100-160	5	0,03800	(F) 0,04161

(*) Value referred to the impeller with maximum diameter.

(*) Valeur se référant à la roue à ailettes avec le diamètre maximum.

(*) Valore riferito alla girante con diametro massimo

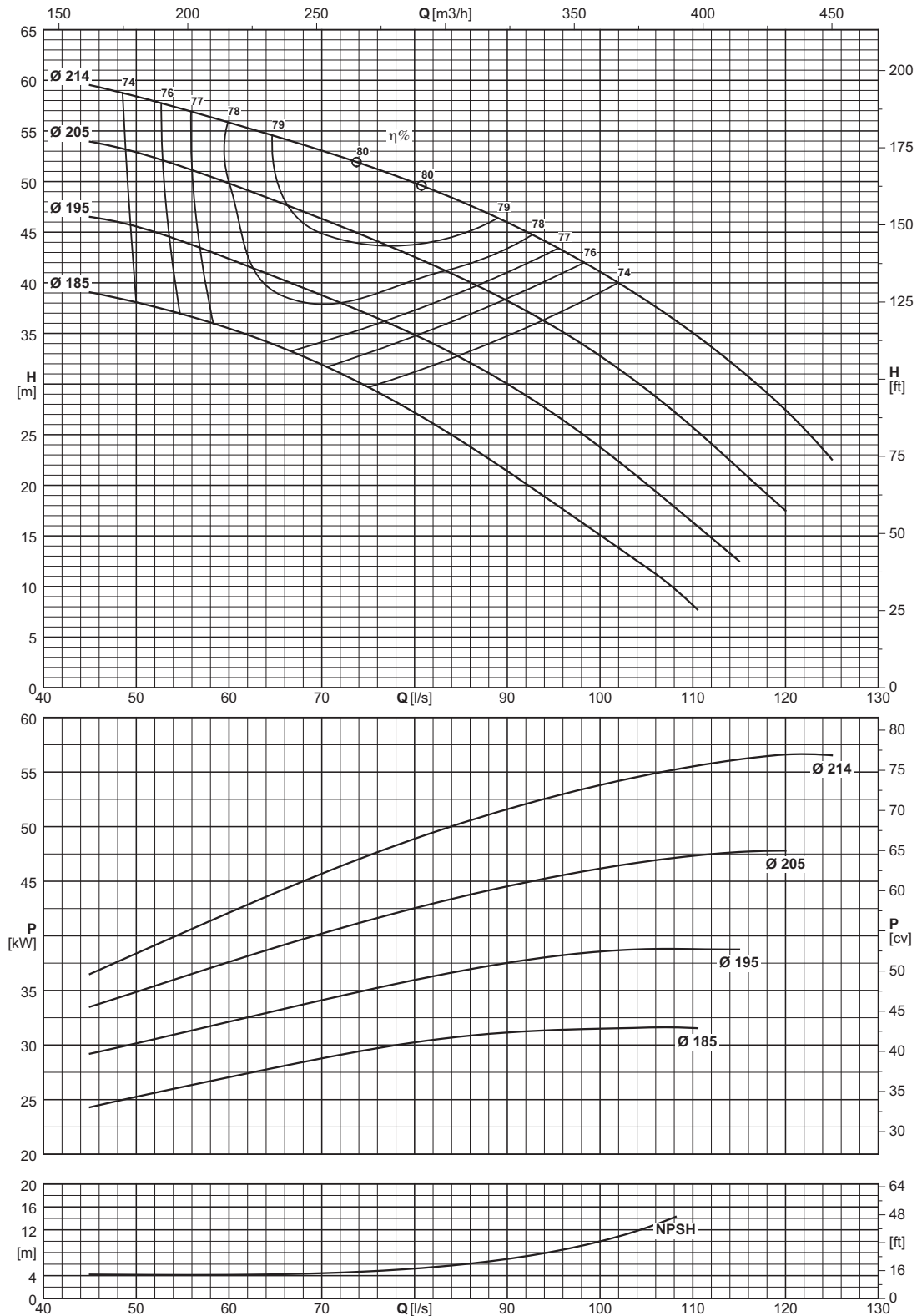

Type Type Tipo	Inlet maximum pressure (*) Pression maximale en aspiration (*) Pressione massima in aspirazione (*)	Dinamic momentum J Momentum dynamique J Momento dinamico J	
		With cast iron impellers Avec roues en fonte Con giranti in ghisa	With AISI 316 impellers Avec roues en AISI 316 Con giranti in AISI 316
		J = 1/4 PD ²	
[bar]		[kgm ²]	
NC100-200	3	0,04830	(F) 0,05289

Construction reference standard EN733 (DIN24255)
(*) Value referred to the impeller with maximum diameter.

Norme de référence construction EN733 (DIN24255)
(*) Valeur se référant à la roue à ailettes avec le diamètre maximum.

Norma di riferimento costruttivo EN733 (DIN24255)
(*) Valore riferito alla girante con diametro massimo

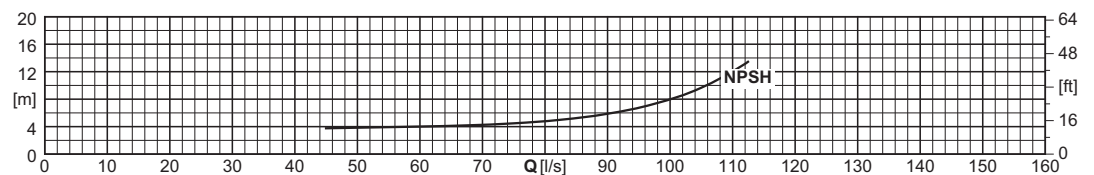
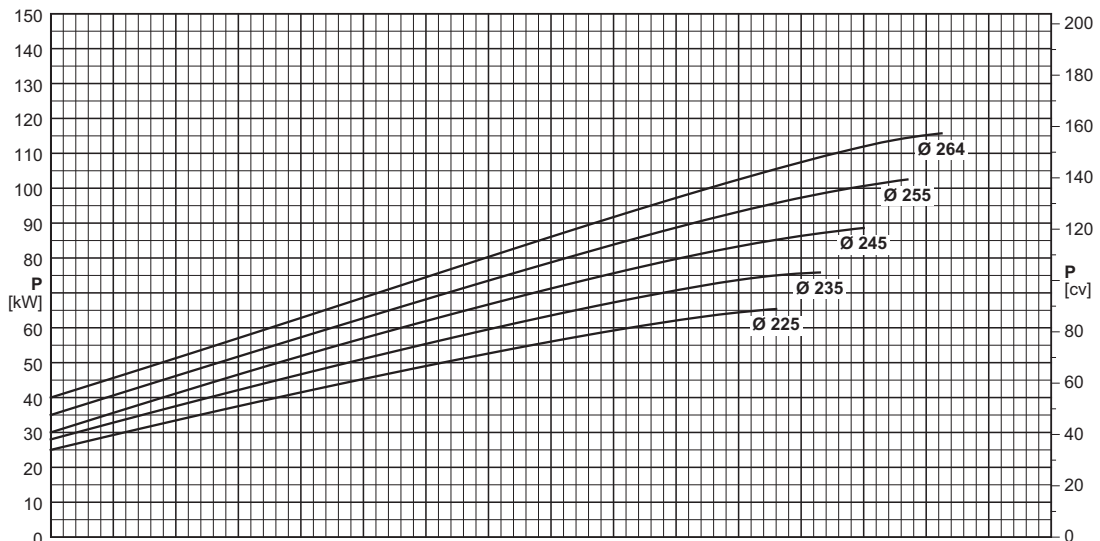
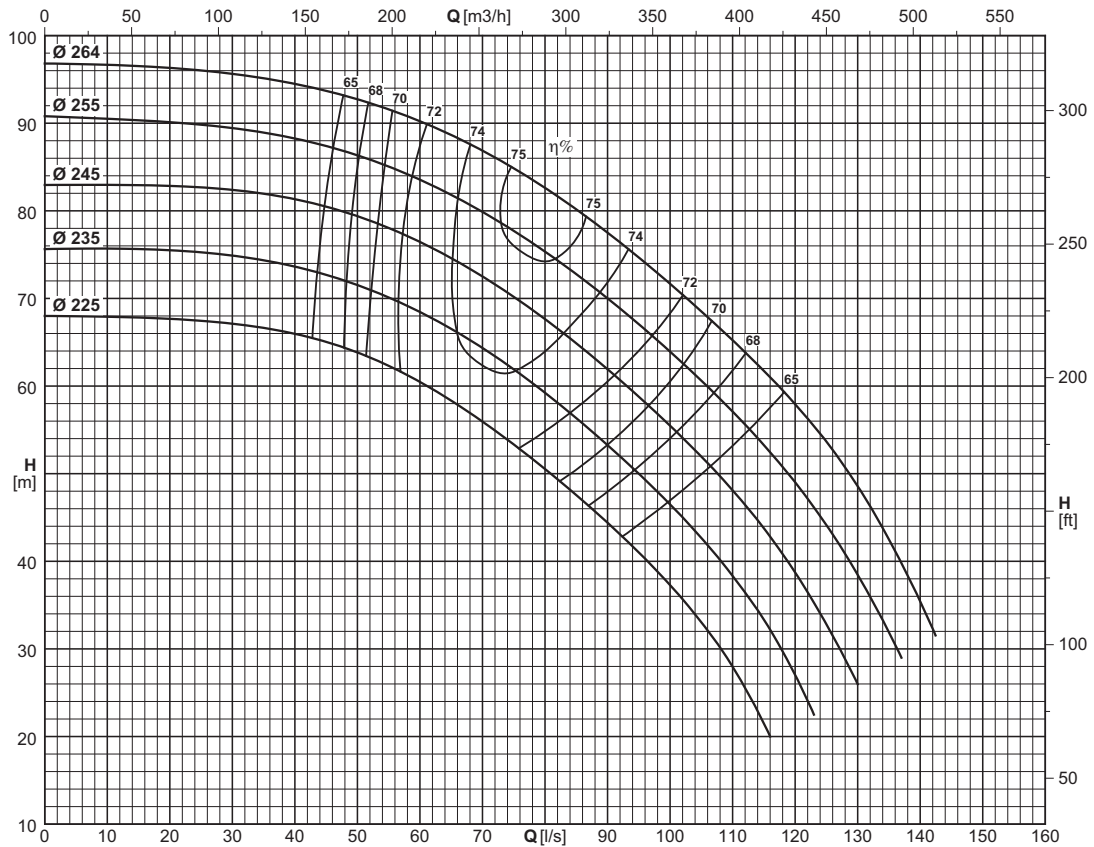

Type Type Tipo	Inlet maximum pressure (*) Pression maximale en aspiration (*) Pressione massima in aspirazione (*)	Dynamic momentum J Momentum dynamique J Momento dinamico J	
		With cast iron impellers Avec roues en fonte Con giranti in ghisa	With AISI 316 impellers Avec roues en AISI 316 Con giranti in AISI 316
		$J = \frac{1}{4}PD^2$	
	[bar]	[kgm ²]	
NC100-250	0	0,08165	(F) 0,08941

Construction reference standard EN733 (DIN24255)
(*) Value referred to the impeller with maximum diameter.

Norme de référence construction EN733 (DIN24255)
(*) Valeur se référant à la roue à ailettes avec le diamètre maximum.

Norma di riferimento costruttivo EN733 (DIN24255)
(*) Valore riferito alla girante con diametro massimo

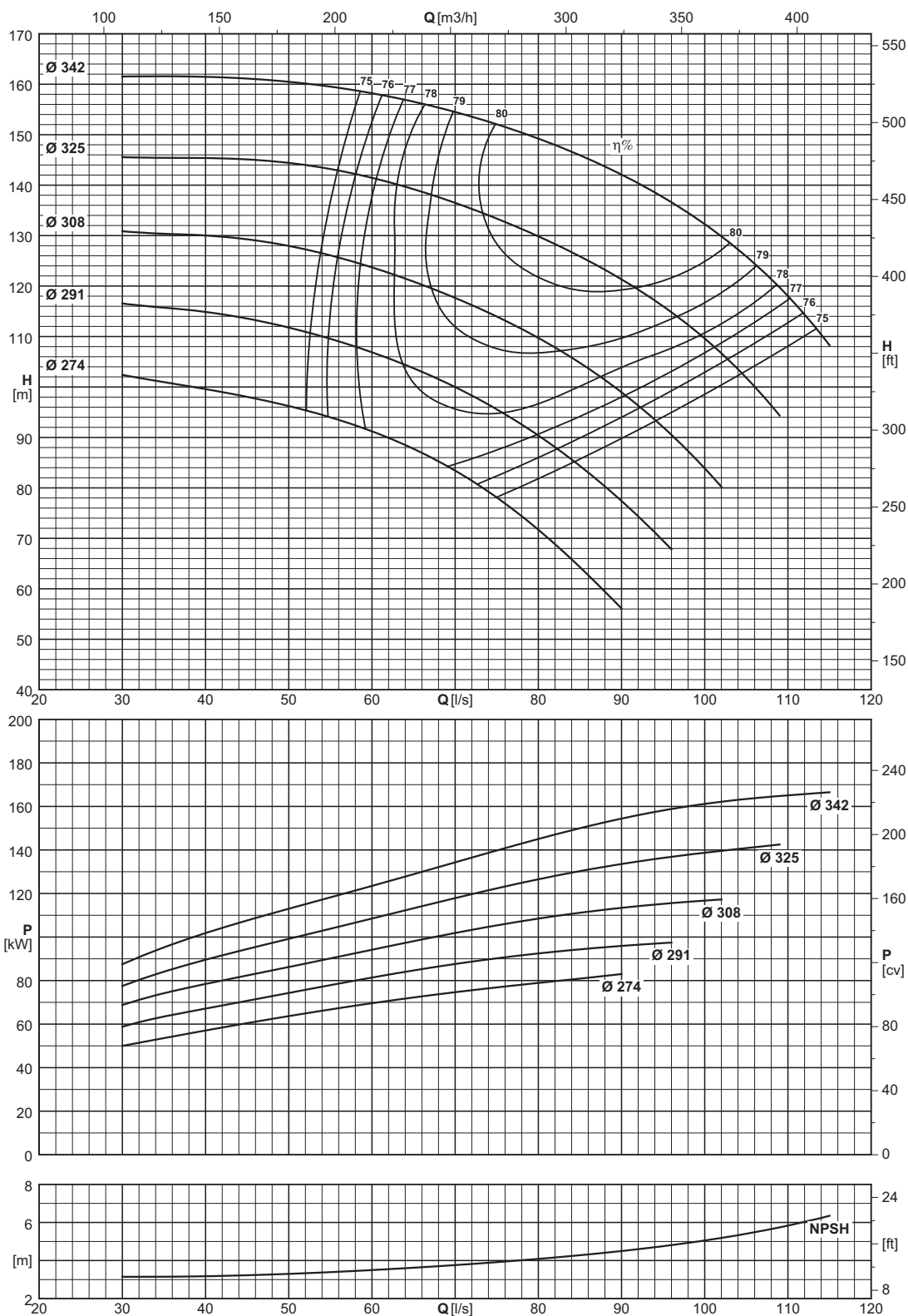

Type Type Tipo	Inlet maximum pressure (*) Pression maximale en aspiration (*) Pressione massima in aspirazione (*)	Dinamic momentum J Momentum dynamique J Momento dinamico J	
		With cast iron impellers Avec roues en fonte Con giranti in ghisa	With AISI 316 impellers Avec roues en AISI 316 Con giranti in AISI 316
		J = 1/4 PD ²	
[bar]		[kgm ²]	
NCH100-315	0	0,25787	(F) 0,27936

(*) Value referred to the impeller with maximum diameter.

(*) Valeur se référant à la roue à ailettes avec le diamètre maximum.

(*) Valore riferito alla girante con diametro massimo

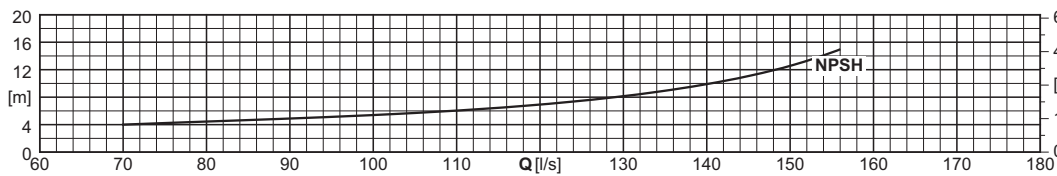
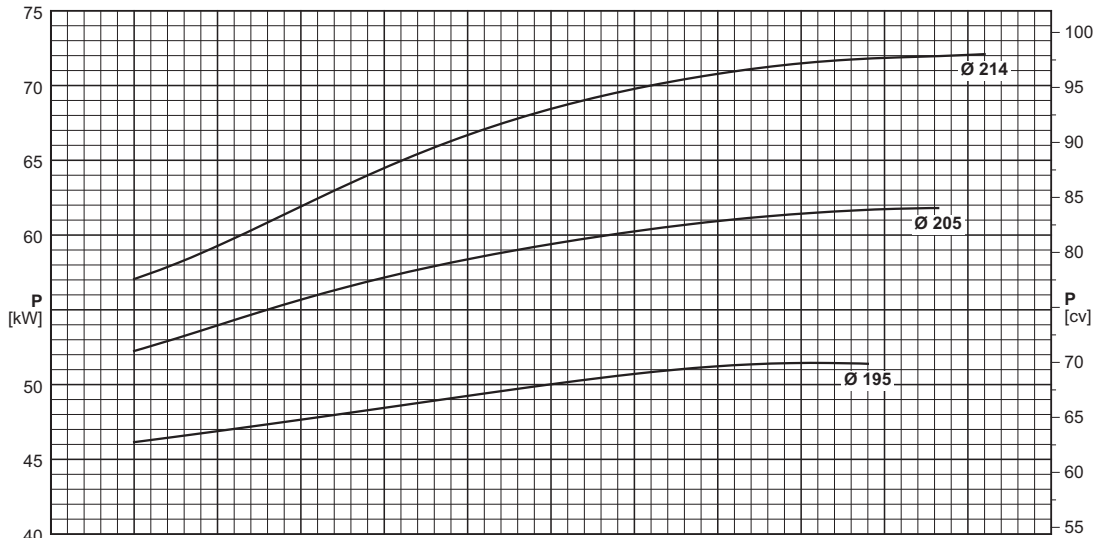
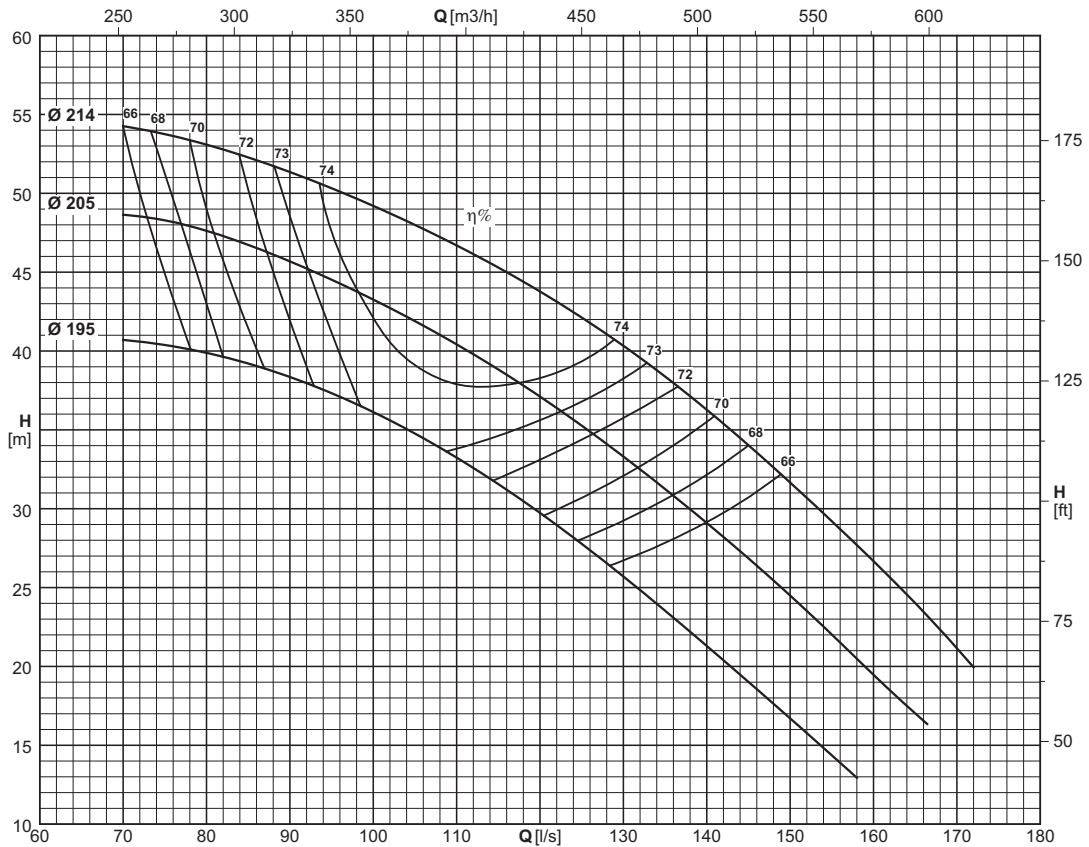

Type Type Tipo	Inlet maximum pressure (*) Pression maximale en aspiration (*) Pressione massima in aspirazione (*)	Dynamic momentum J Momentum dynamique J Momento dinamico J	
		With cast iron impellers Avec roues en fonte Con giranti in ghisa	With AISI 316 impellers Avec roues en AISI 316 Con giranti in AISI 316
		$J = \frac{1}{4}PD^2$	
	[bar]	[kgm ²]	
NC125-200	3	0,06000	(F) 0,06570

(*) Value referred to the impeller with maximum diameter.

(*) Valeur se référant à la roue à ailettes avec le diamètre maximum.

(*) Valore riferito alla girante con diametro massimo

NCH 125-250

2900 n [min⁻¹]

caprari

Operating data
Caracteristiques de fonctionnement
Caratteristiche di funzionamento

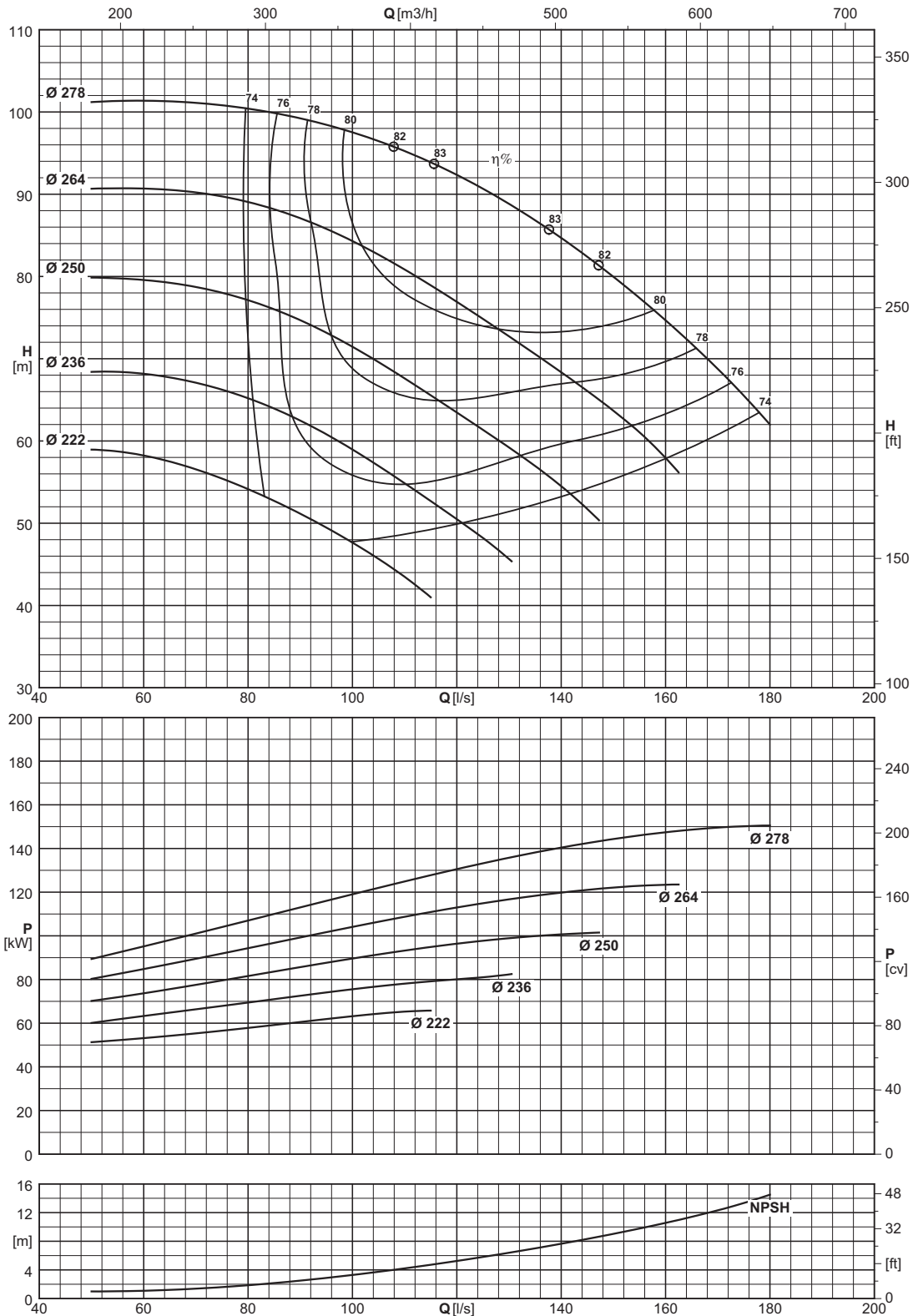

Type Type Tipo	Inlet maximum pressure (*) Pression maximale en aspiration (*) Pressione massima in aspirazione (*)	Dynamic momentum J Momentum dynamique J Momento dinamico J	
		With cast iron impellers Avec roues en fonte Con giranti in ghisa	With AISI 316 impellers Avec roues en AISI 316 Con giranti in AISI 316
		J=1/4PD ²	
[bar]		[kgm ²]	
NCH125-250	5	0,09035	(F) 0,09788

(*) Value referred to the impeller with maximum diameter.

(*) Valeur se référant à la roue à ailettes avec le diamètre maximum.

(*) Valore riferito alla girante con diametro massimo

Overall dimensions and weights
 Dimensions d'encombrement et poids
 Dimensioni di ingombro e pesi

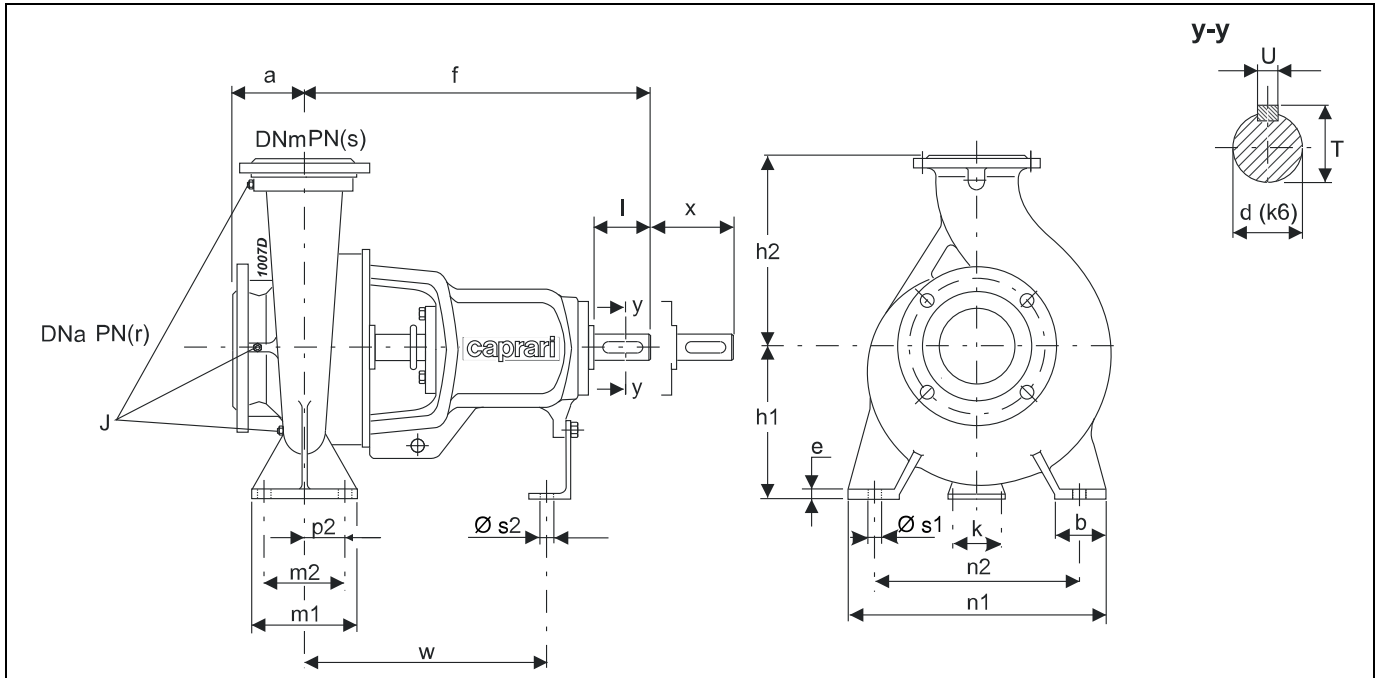

Type Type Tipo	Dimensions pump Dimensions pompe Dimensioni pompa							Duck foot pedestal dimensions Dimensions pieds de soutien Dimensioni piedi di appoggio										Shaft projection Saillie d'arbre Sporgenza d'albero					Plugs Bouchons Tappi	Weight Poids Peso		
	DNa	DNm	r	s	a	f	h1	h2	b	e	m1	m2	p2	n1	n2	k	w	s1	s2	d	l	T	U	X	J	[kg]
	[mm]																									
NC32-125	50	32	16	16	80	360	112	140	50	14	100	70	-	190	140	110	260	Ø 14	Ø 14	24	50	27	8	100	G1/4x2.G3/8.G1/4	28
NC32-160	50	32	16	16	80	360	132	160	50	14	100	70	-	240	190	110	260	Ø 14	Ø 14	24	50	27	8	100	G1/4x2.G3/8.G1/4	35
NC32-200	50	32	16	16	80	360	160	180	50	14	100	70	-	240	190	110	260	Ø 14	Ø 14	24	50	27	8	100	G1/4.G3/8x2.G1/4	41
NC32-250	50	32	16	16	100	360	180	225	65	14	125	95	-	320	250	110	260	Ø 14	Ø 14	24	50	27	8	100	G1/4.G3/8x2.G1/4	59
NC40-125	65	40	16	16	80	360	112	140	50	14	100	70	-	210	160	110	260	Ø 14	Ø 14	24	50	27	8	100	G1/4x2.G3/8.G1/4	30
NC40-160	65	40	16	16	80	360	132	160	50	14	100	70	-	240	190	110	260	Ø 14	Ø 14	24	50	27	8	100	G1/4x2.G3/8.G1/4	36
NC40-200	65	40	16	16	100	360	160	180	50	14	100	70	-	265	212	110	260	Ø 14	Ø 14	24	50	27	8	100	G1/4.G3/8x2.G1/4	44
NC40-250	65	40	16	16	100	360	180	225	65	14	125	95	-	320	250	110	260	Ø 14	Ø 14	24	50	27	8	100	G1/4.G3/8x2.G1/4	61
NC40-315	65	40	16	16	125	470	200	225	65	14	125	95	-	345	280	110	340	Ø 14	Ø 14	32	80	35	10	100	G1/4.G3/8x2.G1/4	96
NC50-125	65	50	16	16	100	360	132	160	50	14	100	70	-	240	190	110	260	Ø 14	Ø 14	24	50	27	8	100	G1/4x2.G3/8.G1/4	34
NC50-160	65	50	16	16	100	360	160	180	50	14	100	70	-	265	212	110	260	Ø 14	Ø 14	24	50	27	8	100	G1/4.G3/8x2.G1/4	38
NC50-200	65	50	16	16	100	360	160	200	50	14	100	70	-	265	212	110	260	Ø 14	Ø 14	24	50	27	8	100	G1/4.G3/8x2.G1/4	46
NC50-250	65	50	16	16	100	360	180	225	65	14	125	95	-	320	250	110	260	Ø 14	Ø 14	24	50	27	8	100	G1/4.G3/8x2.G1/4	71
NC50-315	65	50	16	16	125	470	225	280	65	16	125	95	-	345	280	110	340	Ø 14	Ø 14	32	80	35	10	100	G1/4.G3/8x2.G1/4	101
NCH50-315	80	50	16	25	125	500	225	280	65	18	125	95	-	345	280	110	370	Ø 14	Ø 14	32	80	35	10	100	G1/4x3	87
NC65-125	80	65	16	16	100	360	160	180	65	14	125	95	-	280	212	110	260	Ø 14	Ø 14	24	50	27	8	100	G1/4x2.G3/8.G1/4	39
NC65-160	80	65	16	16	100	360	160	200	65	14	125	95	-	280	212	110	260	Ø 14	Ø 14	24	50	27	8	100	G1/4.G3/8x2.G1/4	43
NC65-200	80	65	16	16	100	360	180	225	65	14	125	95	-	320	250	110	260	Ø 14	Ø 14	24	50	27	8	100	G1/4.G3/8x2.G1/4	52
NC65-250	80	65	16	16	100	470	200	250	80	16	160	120	-	360	280	110	340	Ø 18	Ø 14	32	80	35	10	100	G1/4.G3/8x2.G1/4	81
NC65-315	80	65	16	16	125	470	225	280	80	16	160	120	-	400	315	110	340	Ø 18	Ø 14	32	80	35	10	100	G1/4.G3/8x2.G1/4	110
NCH65-315	100	65	16	16	125	530	225	280	80	18	160	120	-	400	315	110	370	Ø 18	Ø 14	42	110	45	12	140	G1/4x3	118
NC80-160	100	80	16	16	125	360	180	225	65	14	125	95	-	320	250	110	260	Ø 14	Ø 14	24	50	27	8	100	G1/4.G3/8x2.G1/4	54
NC80-200	100	80	16	16	125	470	180	250	65	14	125	95	-	345	280	110	340	Ø 14	Ø 14	32	80	35	10	100	G1/4.G3/8x2.G1/4	75
NC80-250	100	80	16	16	125	470	200	280	80	16	160	120	-	400	315	110	340	Ø 18	Ø 14	32	80	35	10	100	G1/4.G3/8x2.G1/4	91
NC80-315	100	80	16	16	125	470	250	315	80	16	160	120	-	400	315	110	340	Ø 18	Ø 14	32	80	35	10	100	G3/8x3.G3/8	120
NC80-400	100	80	16	16	125	532	280	355	85	16	160	120	-	440	340	110	370	Ø 18	Ø 14	42	110	45	12	140	G3/8x2.G1/2.G1/4	161

Overall dimensions and weights
 Dimensions d'encombrement et poids
 Dimensioni di ingombro e pesi

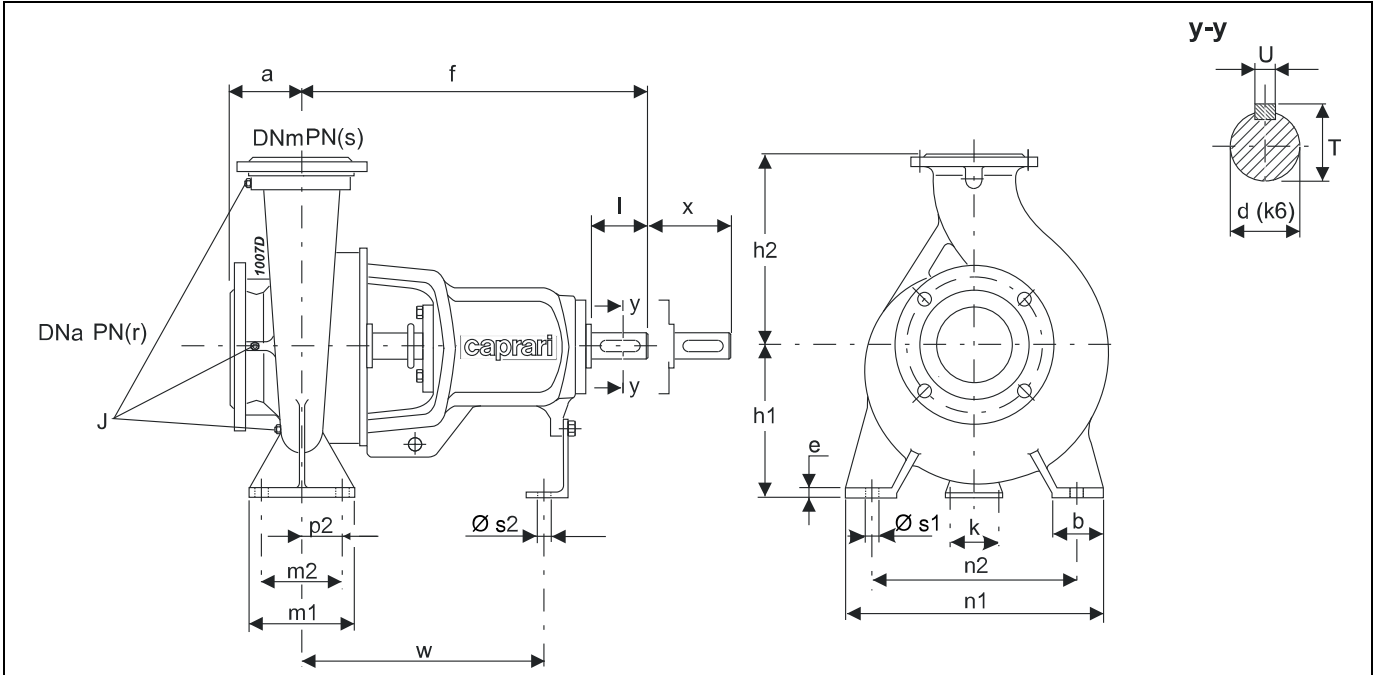

Type Type Tipo	Dimensions pump Dimensions pompe Dimensioni pompa							Duck foot pedestal dimensions Dimensions pieds de soutien Dimensioni piedi di appoggio										Shaft projection Saillie d'arbre Sporgenza d'albero						Plugs Bouchons Tappi	Weight Poids Peso		
	DNa	DNm	r	s	a	f	h1	h2	b	e	m1	m2	p2	n1	n2	k	w	s1	s2	d	l	T	U	X		J	
[mm]																											[kg]
NC100-160	125	100	16	16	125	470	200	250	80	16	160	120	-	360	280	110	340	∅ 18	∅ 14	32	80	35	10	140	G3/8×3. G1/4	71	
NC100-200	125	100	16	16	125	470	200	280	80	16	160	120	-	360	280	110	340	∅ 18	∅ 14	32	80	35	10	140	G3/8×3. G1/4	85	
NC100-250	125	100	16	16	140	470	225	280	80	16	160	120	-	400	315	110	340	∅ 18	∅ 14	32	80	35	10	140	G3/8×3. G3/8	106	
NC100-315	125	100	16	16	140	470	250	315	80	16	160	120	-	400	315	110	340	∅ 18	∅ 14	32	80	35	10	140	G3/8×3. G3/8	134	
NC100-400	125	100	16	16	140	530	280	355	100	18	200	150	-	500	400	110	370	∅ 23	∅ 14	42	110	45	12	140	G3/8×2 G1/2. G1/4	174	
NCH100-315	125	100	16	16	140	530	250	315	80	19	160	120	-	400	315	110	370	∅ 18	∅ 14	42	110	45	12	140	G1/4×3	135	
NC125-200	150	125	16	16	140	470	250	315	80	16	160	120	-	400	315	110	340	∅ 18	∅ 14	32	80	35	10	140	G3/8×3. G3/8	106	
NC125-250	150	125	16	16	140	470	250	355	80	16	160	120	-	400	315	110	340	∅ 18	∅ 14	32	80	35	10	140	G3/8×3. G3/8	125	
NC125-315	150	125	16	16	140	530	280	355	100	18	200	150	-	500	400	110	370	∅ 23	∅ 14	42	110	45	12	140	G3/8×2 G1/2. G1/4	163	
NC125-400	150	125	16	16	140	530	315	400	100	18	200	150	-	500	400	110	370	∅ 23	∅ 14	42	110	45	12	140	G3/8×2 G1/2. G1/4	191	
NCH125-250	150	125	16	16	140	530	250	355	80	19	160	120	-	400	315	110	370	∅ 18	∅ 14	42	110	45	12	140	G1/4×3	140	
NCH125-400	150	125	16	16	140	530	315	400	100	21	200	150	-	500	400	110	370	∅ M20	∅ M12	42	110	45	12	140	G1/4×3	186	
NCH125-500	150	125	16	16	160	670	355	450	100	25	200	150	-	550	450	140	500	∅ M20	∅ M16	48	110	51,5	14	180	G1/4×3	359	
NC150-200	200	150	16	16	160	495	280	400	100	20	200	150	-	550	450	110	370	∅ 23	∅ 14	32	80	35	10	180	G3/8×3. G1/4	181	
NC150-250	200	150	16	16	160	530	250	355	100	18	200	150	-	450	350	110	370	∅ 23	∅ 14	42	110	45	12	140	G1/4. G3/8×2 G1/2. G3/8	148	
NC150-315	200	150	16	16	160	530	280	400	100	18	200	150	-	550	450	110	370	∅ 23	∅ 14	42	110	45	12	140	G1/4×3	170	
NC150-400	200	150	16	16	160	530	315	450	100	18	200	150	-	550	450	110	370	∅ 23	∅ 14	42	110	45	12	140	G3/8×2 G1/2. G1/4	209	
NCH150-500	200	150	16	16	160	670	400	500	100	25	200	150	60	550	450	140	480	∅ 23	∅ 18	60	140	64	18	180	G3/8×3	410	
NC200-250	250	200	16	16	180	553	315	450	100	20	200	150	-	550	450	110	393	∅ 28	∅ 14	42	110	45	12	180	G3/8×2 G1/2. G3/8	220	
NC200-315	250	200	16	16	180	670	315	480	120	20	220	170	-	600	480	110	504	∅ 28	∅ 14	48	110	51	14	180	G3/8×3. G3/8	251	
NC200-400	250	200	16	16	180	670	335	480	120	20	220	170	-	600	480	110	504	∅ 28	∅ 14	48	110	51	14	180	G3/8×3. G3/8	295	
NCH200-500	250	200	16	16	225	885	400	580	150	28	315	250	-	760	630	180	670	∅ M24	∅ M16	65	140	69	18	250	G3/8×3	577	
NC250-315	300	250	16	16	220	691	355	520	150	22	250	200	-	660	510	110	525	∅ 28	∅ 14	48	110	51	14	180	G3/8×3. G3/8	311	
NC250-400	300	250	16	16	220	682	400	560	150	22	250	200	-	660	510	110	516	∅ 28	∅ 14	48	110	51	14	180	G3/8×3. G3/8	390	
NCH250-250	300	250	16	16	225	885	355	560	125	24	250	190	-	630	500	180	670	∅ M20	∅ M16	65	140	69	18	250	G3/8×3	434	
NCHF250-500	300	250	16	16	225	885	450	630	150	28	315	250	-	760	630	180	670	∅ M24	∅ M16	65	140	69	18	250	G3/8×3	460	

Selection - dimensions and weights for base mounted electric pumps
 Sélection - dimensions et poids des électropompes sur socle
 Selezione - dimensioni e pesi elettropompe su base

COUPLINGS WITH STANDARDIZED ENCLOSED ELECTRIC MOTORS
 ACCOUPLEMENTS AVEC MOTEURS ÉLECTRIQUES FERMÉS NORMALISÉS
 ACCOPIAMENTI CON MOTORI ELETTRICI CHIUSI NORMALIZZATI

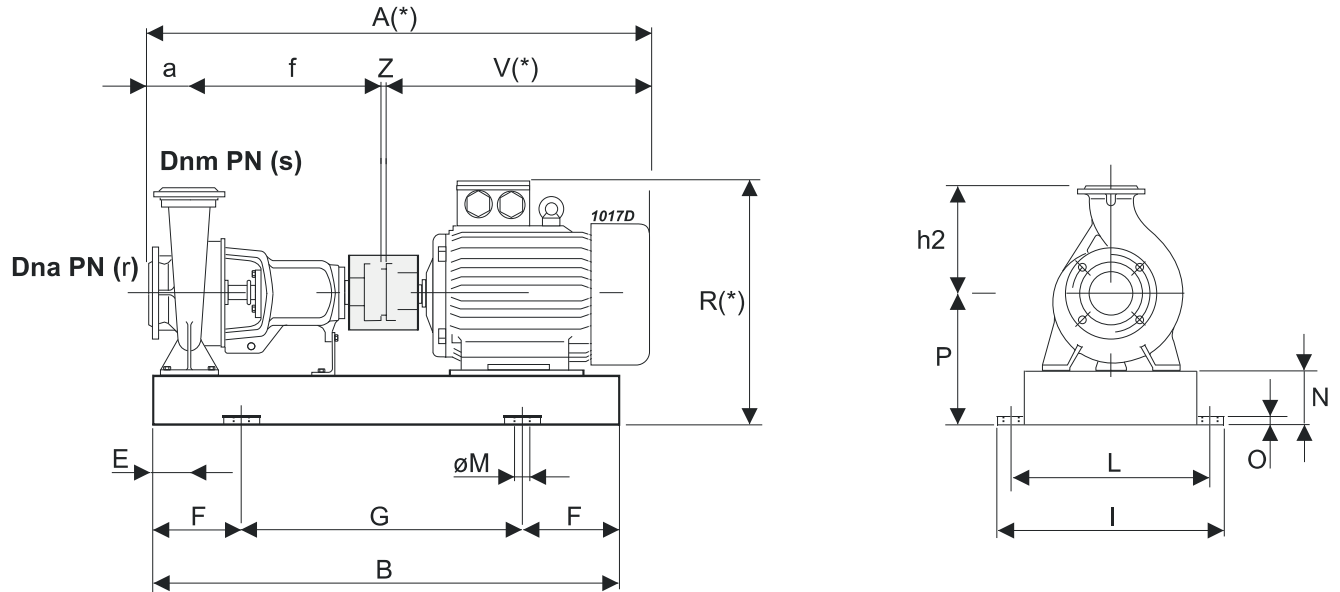

(*)Valori indicativi in funzione della marca di motore utilizzato
 Indicative values according to the type of motor installed

107D

Pump Pompe Pompa		Motor Moteur Motore		BGAN	A *	B	E	F	G	I	L	M	N	O	P	R *	V *	Z	a	f	h2	r	s	Weight Poids Peso	
Type Type Tipo	DNa [mm]	DNm [mm]	[kW] kW	Size Taille Grand.	Type Type Tipo	[mm]																			
NC32-125	50	32	1,1	80M	1001/CA	739	689	70	100	489	340	290	ø 16	65	38	177	302	295	4	80	360	140	16	16	51
NC32-125	50	32	1,5	90S	1002/CA	799	710	70	100	510	340	290	ø 16	65	38	177	315	355	4	80	360	140	16	16	64
NC32-125	50	32	2,2	90L	1003/CA	829	735	70	100	535	340	290	ø 16	65	38	177	315	385	4	80	360	140	16	16	64
NC32-160	50	32	2,2	90L	1004/CA	829	735	70	100	535	390	340	ø 16	65	38	197	335	385	4	80	360	160	16	16	67
NC32-160	50	32	3	100L	1005/CA	849	767	70	100	567	390	340	ø 16	65	38	197	347	405	4	80	360	160	16	16	76
NC32-160	50	32	4	112M	1006/CA	884	774	70	100	574	390	340	ø 16	65	38	197	369	440	4	80	360	160	16	16	82
NC32-160	50	32	5,5	132S	1007/CA	899	803	60	100	618	415	365	ø 16	65	38	197	389	455	4	80	360	160	16	16	111
NC32-160	50	32	7,5	132S	1007/CA	899	803	60	100	618	415	365	ø 16	65	38	197	389	455	4	80	360	160	16	16	111
NC32-200	50	32	5,5	132S	1008/CA	899	818	70	100	618	415	365	ø 16	80	38	240	432	455	4	80	360	180	16	16	114
NC32-200	50	32	7,5	132S	1008/CA	899	818	70	100	618	415	365	ø 16	80	38	240	432	455	4	80	360	180	16	16	114
NC32-200	50	32	11	160M	1009/DA	1071	937	70	100	737	465	415	ø 16	80	38	240	491	627	4	80	360	180	16	16	150
NC32-250	50	32	11	160M	1014/DA	1091	950	82,5	100	750	470	420	ø 20	100	38	280	531	627	4	100	360	225	16	16	179
NC32-250	50	32	15	160M	1014/DA	1091	950	82,5	100	750	470	420	ø 20	100	38	280	531	627	4	100	360	225	16	16	179
NC32-250	50	32	18,5	160L	1015/DA	1091	994	82,5	100	794	470	420	ø 20	100	38	280	531	627	4	100	360	225	16	16	205
NC40-125	65	40	1,5	90S	1010/CA	799	710	70	100	510	360	310	ø 16	65	38	177	315	355	4	80	360	140	16	16	66
NC40-125	65	40	2,2	90L	1011/CA	829	735	70	100	535	360	310	ø 16	65	38	177	315	385	4	80	360	140	16	16	66
NC40-125	65	40	3	100L	1150/CA	849	765	70	100	565	360	310	ø 16	65	38	177	327	405	4	80	360	140	16	16	68
NC40-160	65	40	3	100L	1005/CA	849	767	70	100	567	390	340	ø 16	65	38	197	347	405	4	80	360	160	16	16	76
NC40-160	65	40	4	112M	1006/CA	884	774	70	100	574	390	340	ø 16	65	38	197	369	440	4	80	360	160	16	16	82
NC40-160	65	40	5,5	132S	1007/CA	899	803	60	100	618	415	365	ø 16	65	38	197	389	455	4	80	360	160	16	16	111
NC40-160	65	40	7,5	132S	1007/CA	899	803	60	100	618	415	365	ø 16	65	38	197	389	455	4	80	360	160	16	16	111
NC40-200	65	40	5,5	132S	1012/CA	919	818	70	150	518	415	365	ø 16	80	38	240	432	455	4	100	360	180	16	16	117
NC40-200	65	40	7,5	132S	1012/CA	919	818	70	150	518	415	365	ø 16	80	38	240	432	455	4	100	360	180	16	16	120
NC40-200	65	40	11	160M	1013/DA	1091	912	60	100	712	465	415	ø 16	80	38	240	491	627	4	100	360	180	16	16	170
NC40-200	65	40	15	160M	1013/DA	1091	912	60	100	712	465	415	ø 16	80	38	240	491	627	4	100	360	180	16	16	170
NC40-250	65	40	11	160M	1014/DA	1091	950	82,5	100	750	470	420	ø 20	100	38	280	531	627	4	100	360	225	16	16	169
NC40-250	65	40	15	160M	1014/DA	1091	950	82,5	100	750	470	420	ø 20	100	38	280	531	627	4	100	360	225	16	16	179
NC40-250	65	40	18,5	160L	1015/DA	1091	994	82,5	100	794	470	420	ø 20	100	38	280	531	627	4	100	360	225	16	16	205
NC40-250	65	40	22	180M	1016/EA	1129	990	82,5	100	790	490	440	ø 20	80	38	260	530	665	4	100	360	225	16	16	245
NC40-250	65	40	30	200L	1017/FA	1202	1075	90,5	200	675	540	490	ø 20	100	42	300	600	738	4	100	360	225	16	16	343
NC40-250	65	40	37	200L	1017/FA	1202	1075	90,5	200	675	540	490	ø 20	100	42	300	600	738	4	100	360	225	16	16	343
NC50-125	65	50	2,2	90L	1004/CA	849	735	70	100	535	390	340	ø 16	65	38	197	335	385	4	100	360	160	16	16	67
NC50-125	65	50	3	100L	1005/CA	869	767	70	100	567	390	340	ø 16	65	38	197	347	405	4	100	360	160	16	16	76
NC50-125	65	50	4	112M	1121/CA	904	774	60	100	574	390	340	ø 16	80	38	212	384	440	4	100	360	160	16	16	80
NC50-125	65	50	5,5	132S	1122/CA	919	793	60	100	593	415	365	ø 16	65	38	197	389	455	4	100	360	160	16	16	83
NC50-160	65	50	4	112M	1018/CA	904	764	60	100	564	415	365	ø 16	80	38	240	412	440	4	100	360	180	16	16	87

Selection - dimensions and weights for base mounted electric pumps
Sélection - dimensions et poids des électropompes sur socle
Selezione - dimensioni e pesi elettropompe su base

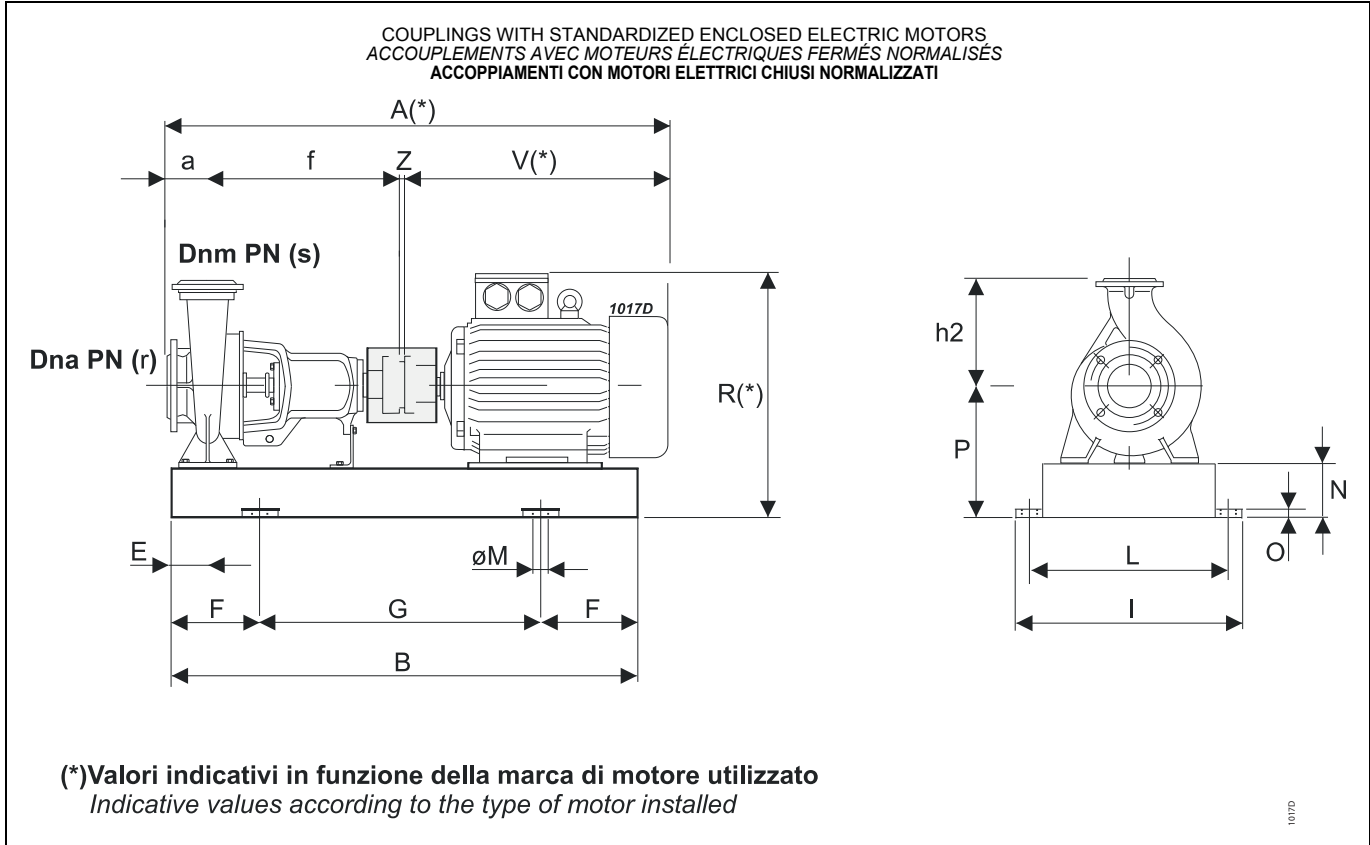

Pump Pompe Pompa		Motor Moteur Motore		BGAN	A*	B	E	F	G	I	L	M	N	O	P	R*	V*	Z	a	f	h2	r	s	Weight Poids Peso	
Type Type Tipo	DNa [mm]	DNm [mm]	[kW] kW	Size Taille Grand.	Type Type Tipo	[mm]																			
NC50-160	65	50	5,5	132S	1012/CA	919	818	70	150	518	415	365	ø 16	80	38	240	432	455	4	100	360	180	16	16	120
NC50-160	65	50	7,5	132S	1012/CA	919	818	70	150	518	415	365	ø 16	80	38	240	432	455	4	100	360	180	16	16	120
NC50-160	65	50	11	160M	1013/DA	1091	912	60	100	712	465	415	ø 16	80	38	240	491	627	4	100	360	180	16	16	170
NC50-160	65	50	15	160M	1013/DA	1091	912	60	100	712	465	415	ø 16	80	38	240	491	627	4	100	360	180	16	16	170
NC50-200	65	50	11	160M	1013/DA	1091	912	60	100	712	465	415	ø 16	80	38	240	491	627	4	100	360	200	16	16	170
NC50-200	65	50	15	160M	1013/DA	1091	912	60	100	712	465	415	ø 16	80	38	240	491	627	4	100	360	200	16	16	170
NC50-200	65	50	18,5	160L	1155/CA	1091	982	70	100	781,5	465	415	ø 20	80	42	240	491	627	4	100	360	200	16	16	175
NC50-250	65	50	18,5	160L	1015/DA	1091	994	82,5	100	794	470	420	ø 20	100	38	280	531	627	4	100	360	225	16	16	205
NC50-250	65	50	22	180M	1016/EA	1129	990	82,5	100	790	490	440	ø 20	80	38	260	530	665	4	100	360	225	16	16	245
NC50-250	65	50	30	200L	1017/FA	1202	1075	90,5	200	675	540	490	ø 20	100	42	300	600	738	4	100	360	225	16	16	343
NC50-250	65	50	37	200L	1017/FA	1202	1075	90,5	200	675	540	490	ø 20	100	42	300	600	738	4	100	360	225	16	16	343
NCH50-315	80	50	22	180M	2000/EX	1294	1108	82,5	200	708	520	470	ø 16	100	38	325	595	665	4	125	500	280	16	25	304
NCH50-315	80	50	30	200L	2001/FX	1367	1184	82,5	200	784	560	510	ø 16	100	38	325	625	738	4	125	500	280	16	25	360
NCH50-315	80	50	37	200L	2001/FX	1367	1184	82,5	200	784	560	510	ø 16	100	38	325	625	738	4	125	500	280	16	25	360
NCH50-315	80	50	45	225M	2002/FX	1404	1216	82,5	200	816	605	555	ø 16	100	38	325	655	775	4	125	500	280	16	25	439
NCH50-315	80	50	55	250M	2003/GX	1499	1343	77,5	200	943	655	605	ø 20	120	42	370	745	870	4	125	500	280	16	25	539
NCH50-315	80	50	75	280S	2004/HX	1579	1374	82,5	250	874	705	655	ø 20	140	42	420	810	950	4	125	500	280	16	25	680
NCH50-315	80	50	90	280M	2005/HX	1629	1425	82,5	250	925	705	655	ø 20	140	42	420	810	1000	4	125	500	280	16	25	711
NC65-125	80	65	5,5	132S	1019/CA	919	830	82,5	100	630	430	380	ø 20	80	38	240	432	455	4	100	360	180	16	16	122
NC65-125	80	65	7,5	132S	1019/CA	919	830	82,5	100	630	430	380	ø 20	80	38	240	432	455	4	100	360	180	16	16	122
NC65-125	80	65	11	160M	1020/DA	1091	924	72,5	100	724	465	415	ø 16	80	38	240	491	627	4	100	360	180	16	16	173
NC65-160	80	65	7,5	132S	1019/CA	919	830	82,5	100	630	430	380	ø 20	80	38	240	432	455	4	100	360	200	16	16	122
NC65-160	80	65	11	160M	1020/DA	1091	924	72,5	100	724	465	415	ø 16	80	38	240	491	627	4	100	360	200	16	16	173
NC65-160	80	65	15	160M	1020/DA	1091	924	72,5	100	724	465	415	ø 16	80	38	240	491	627	4	100	360	200	16	16	173
NC65-160	80	65	18,5	160L	1123/DA	1091	990	82,5	100	790	465	415	ø 20	80	42	240	491	627	4	100	360	200	16	16	175
NC65-200	80	65	11	160M	1014/DA	1091	950	82,5	100	750	470	420	ø 20	100	38	280	531	627	4	100	360	225	16	16	179
NC65-200	80	65	15	160M	1014/DA	1091	950	82,5	100	750	470	420	ø 20	100	38	280	531	627	4	100	360	225	16	16	179
NC65-200	80	65	18,5	160L	1015/DA	1091	994	82,5	100	794	470	420	ø 20	100	38	280	531	627	4	100	360	225	16	16	205
NC65-200	80	65	22	180M	1016/EA	1129	990	82,5	100	790	490	440	ø 20	80	38	260	530	665	4	100	360	225	16	16	245
NC65-200	80	65	30	200L	1017/FA	1202	1075	90,5	200	675	540	490	ø 20	100	42	300	600	738	4	100	360	225	16	16	343
NC65-200	80	65	37	200L	1017/FA	1202	1075	90,5	200	675	540	490	ø 20	100	42	300	600	738	4	100	360	225	16	16	362
NC65-250	80	65	30	200L	1021/FX	1312	1190	95	200	790	520	470	ø 20	100	50	300	600	738	4	100	470	250	16	16	356
NC65-250	80	65	37	200L	1021/FX	1312	1190	95	200	790	520	470	ø 20	100	50	300	600	738	4	100	470	250	16	16	356
NC65-250	80	65	45	225M	1022/FX	1349	1214	103	200	814	585	535	ø 20	100	42	325	655	775	4	100	470	250	16	16	428
NCH65-315	100	65	37	200L	2006/FX	1397	1227	95	200	827	560	510	ø 16	100	38	325	625	738	4	125	530	280	16	16	392
NCH65-315	100	65	45	225M	2007/FX	1434	1259	95	200	859	605	555	ø 16	100	38	325	655	775	4	125	530	280	16	16	471

Selection - dimensions and weights for base mounted electric pumps
 Sélection - dimensions et poids des électropompes sur socle
 Selezione - dimensioni e pesi elettropompe su base

COUPLINGS WITH STANDARDIZED ENCLOSED ELECTRIC MOTORS
 ACCOUPLEMENTS AVEC MOTEURS ÉLECTRIQUES FERMÉS NORMALISÉS
 ACCOPIAMENTI CON MOTORI ELETTRICI CHIUSI NORMALIZZATI

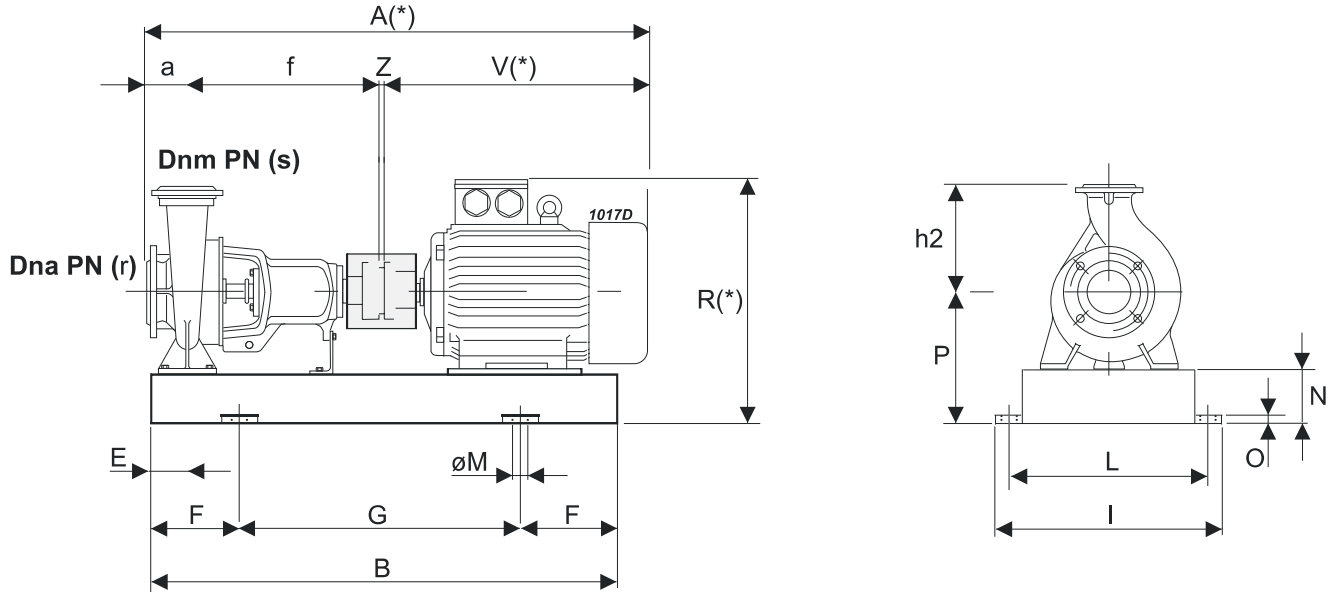

(*)Valori indicativi in funzione della marca di motore utilizzato
 Indicative values according to the type of motor installed

1017D

Pump Type Tipo		DNa	DNm	[kW]	Size Taille Grand.	BGAN	A*	B	E	F	G	I	L	M	N	O	P	R*	V*	Z	a	f	h2	r	s	Weight Poids Peso				
Type	Type	[mm]	[mm]	kW	Type	Type	[mm]																							
NCH65-315		100	65	55	250M	2008/GX	1529	1386	90	200	986	655	605	ø 20	120	42	370	745	870	4	125	530	280	16	16	570				
NCH65-315		100	65	75	280S	2009/HX	1609	1417	95	250	917	705	655	ø 20	140	42	420	810	950	4	125	530	280	16	16	710				
NCH65-315		100	65	90	280M	2010/HX	1659	1468	95	250	968	705	655	ø 20	140	42	420	810	1000	4	125	530	280	16	16	742				
NCH65-315		100	65	110	315S	2011/HX	1839	1481	95	250	981	800	750	ø 22	160	50	475	1030	1180	4	125	530	280	16	16	1143				
NCH65-315		100	65	132	315M	2012/HX	1938	1583	95	250	1083	800	750	ø 22	160	50	475	1030	1279	4	125	530	280	16	16	1194				
NCH65-315		100	65	160	315L	2012/IX	1938	1583	95	250	1083	800	750	ø 22	160	50	475	1030	1279	4	125	530	280	16	16	1306				
NC80-160		100	80	11	160M	1014/DA	1116	950	82,5	100	750	470	420	ø 20	100	38	280	531	627	4	125	360	225	16	16	179				
NC80-160		100	80	15	160M	1014/DA	1116	950	82,5	100	750	470	420	ø 20	100	38	280	531	627	4	125	360	225	16	16	179				
NC80-160		100	80	18,5	160L	1015/DA	1116	994	82,5	100	794	470	420	ø 20	100	38	280	531	627	4	125	360	225	16	16	205				
NC80-160		100	80	22	180M	1016/EA	1154	990	82,5	100	790	490	440	ø 20	80	38	260	530	665	4	125	360	225	16	16	245				
NC80-160		100	80	30	200L	1017/FA	1227	1075	90,5	200	675	540	490	ø 20	100	42	300	600	738	4	125	360	225	16	16	296				
NC80-200		100	80	15	160M	1023/DX	1226	1060	72,5	150	760	490	440	ø 20	100	50	280	531	627	4	125	470	250	16	16	205				
NC80-200		100	80	18,5	160L	1024/DX	1226	1104	92,5	150	804	490	440	ø 20	100	50	280	531	627	4	125	470	250	16	16	230				
NC80-200		100	80	22	180M	1025/EX	1264	1100	82,5	200	700	490	440	ø 20	100	50	280	550	665	4	125	470	250	16	16	270				
NC80-200		100	80	30	200L	1026/FX	1337	1203	92,5	200	803	540	490	ø 20	100	42	300	600	738	4	125	470	250	16	16	365				
NC80-200		100	80	37	200L	1026/FX	1337	1203	92,5	200	803	540	490	ø 20	100	42	300	600	738	4	125	470	250	16	16	365				
NC80-200		100	80	45	225M	1124/FX	1374	1207	92,5	200	807	585	535	ø 20	100	42	325	655	775	4	125	470	250	16	16	398				
NC80-250		100	80	37	200L	1027/FX	1337	1205	95	200	805	550	500	ø 20	100	42	300	600	738	4	125	470	280	16	16	356				
NC80-250		100	80	45	225M	1028/FX	1374	1208	95	200	808	585	535	ø 20	100	42	325	655	775	4	125	470	280	16	16	428				
NC80-250		100	80	55	250M	1029/GX	1469	1321	107,5	250	821	635	585	ø 20	120	42	370	745	870	4	125	470	280	16	16	535				
NC80-250		100	80	75	280S	1030/HX	1549	1362	107,5	250	862	675	625	ø 20	140	42	420	810	950	4	125	470	280	16	16	710				
NC100-160		125	100	22	180M	1031/EX	1264	1133	95	200	733	510	460	ø 20	100	42	300	570	665	4	125	470	250	16	16	271				
NC100-160		125	100	30	200L	1021/FX	1337	1190	95	200	790	520	470	ø 20	100	50	300	600	738	4	125	470	250	16	16	356				
NC100-160		125	100	37	200L	1021/FX	1337	1190	95	200	790	520	470	ø 20	100	50	300	600	738	4	125	470	250	16	16	375				
NC100-200		125	100	22	180M	1031/EX	1264	1133	95	200	733	510	460	ø 20	100	42	300	570	665	4	125	470	280	16	16	271				
NC100-200		125	100	30	200L	1021/FX	1337	1190	95	200	790	520	470	ø 20	100	50	300	600	738	4	125	470	280	16	16	356				
NC100-200		125	100	37	200L	1021/FX	1337	1190	95	200	790	520	470	ø 20	100	50	300	600	738	4	125	470	280	16	16	356				
NC100-200		125	100	45	225M	1022/FX	1374	1214	103	200	814	585	535	ø 20	100	42	325	655	775	4	125	470	280	16	16	428				
NC100-200		125	100	55	250M	1032/GX	1469	1320	107,5	250	820	630	580	ø 20	120	42	370	745	870	4	125	470	280	16	16	535				
NC100-200		125	100	75	280S	1125/HX	1549	1383	107,5	200	983	695	645	ø 20	100	42	380	770	950	4	125	470	280	16	16	440				
NC100-250		125	100	45	225M	1033/FX	1389	1236	95	200	836	585	535	ø 20	100	42	325	655	775	4	140	470	280	16	16	440				
NC100-250		125	100	55	250M	1034/GX	1484	1329	105	200	929	635	585	ø 20	120	42	370	745	870	4	140	470	280	16	16	540				
NC100-250		125	100	75	280S	1035/HE	1564	1360	107,5	250	860	675	625	ø 20	140	42	420	810	950	4	140	470	280	16	16	715				
NC100-250		125	100	90	280M	1036/HE	1614	1434	107,5	250	934	695	645	ø 20	140	42	420	810	1000	4	140	470	280	16	16	792				
NC100-250		125	100	110	315S	1126/IX	1794	1424	107,5	250	924	780	730	ø 22	160	50	475	1030	1180	4	140	470	280	16	16	815				

Selection - dimensions and weights for base mounted electric pumps
Sélection - dimensions et poids des électropompes sur socle
Selezione - dimensioni e pesi elettropompe su base

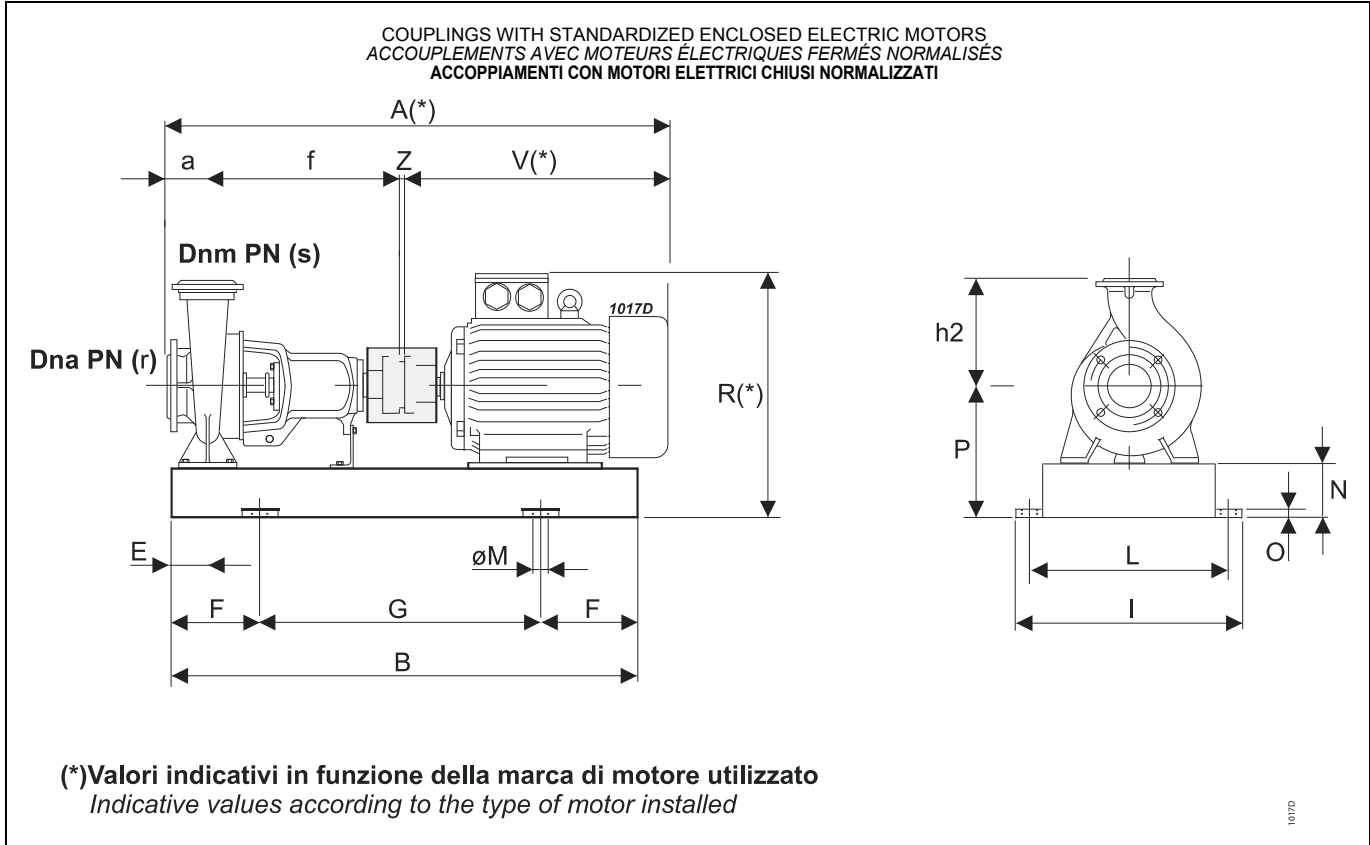

Pump Pompe Pompa		Motor Moteur Motore		BGAN	A*	B	E	F	G	I	L	M	N	O	P	R*	V*	Z	a	f	h2	r	s	Weight Poids Peso	
Type Type Tipo	DNa [mm]	DNm [mm]	[kW] kW	Size Taille Grand.	Type Type Tipo	[mm]																			
NCH100-315	125	100	55	250M	2013/GX	1544	1356	95	200	956	655	605	ø 20	120	42	370	745	870	4	140	530	315	16	16	585
NCH100-315	125	100	75	280S	2014/HX	1624	1427	90	250	827	705	655	ø 20	140	42	420	810	950	4	140	530	315	16	16	735
NCH100-315	125	100	90	280M	2015/HX	1674	1478	90	250	978	705	655	ø 20	140	42	420	810	1000	4	140	530	315	16	16	766
NCH100-315	125	100	110	315S	2016/HX	1854	1481	95	250	981	800	750	ø 22	160	50	475	1030	1180	4	140	530	315	16	16	1160
NCH100-315	125	100	132	315M	2017/HX	1953	1598	110	250	1098	800	750	ø 22	160	50	475	1030	1279	4	140	530	315	16	16	1213
NCH100-315	125	100	160	315L	2017/IX	1953	1598	110	250	1098	800	750	ø 22	160	50	475	1030	1279	4	140	530	315	16	16	1323
NCH100-315	125	100	200	315L	2017/LX	1953	1598	110	250	1098	800	750	ø 22	160	50	475	1030	1279	4	140	530	315	16	16	1413
NC125-200	150	125	55	250M	1094/GX	1484	1329	95	250	829	635	585	ø 20	120	42	370	745	870	4	140	470	315	16	16	540
NC125-200	150	125	75	280S	1095/HE	1564	1347	95	250	847	695	645	ø 20	140	45	420	810	950	4	140	470	315	16	16	715
NC125-200	150	125	90	280M	1107/HE	1614	1398	95	250	898	695	645	ø 20	140	45	420	810	1000	4	140	470	315	16	16	792
NCH125-250	150	125	55	250M	2013/GX	1544	1356	95	200	956	655	605	ø 20	120	42	370	745	870	4	140	530	355	16	16	590
NCH125-250	150	125	75	280S	2014/HX	1624	1427	90	250	827	705	655	ø 20	140	42	420	810	950	4	140	530	355	16	16	740
NCH125-250	150	125	90	280M	2015/HX	1674	1478	90	250	978	705	655	ø 20	140	42	420	810	1000	4	140	530	355	16	16	771
NCH125-250	150	125	110	315S	2016/HX	1854	1481	95	250	981	800	750	ø 22	160	50	475	1030	1180	4	140	530	355	16	16	1165
NCH125-250	150	125	132	315M	2017/HX	1953	1598	110	250	1098	800	750	ø 22	160	50	475	1030	1279	4	140	530	355	16	16	1218
NCH125-250	150	125	160	315L	2017/IX	1953	1598	110	250	1098	800	750	ø 22	160	50	475	1030	1279	4	140	530	355	16	16	1328
NCH125-250	150	125	200	315L	2017/LX	1953	1598	110	250	1098	800	750	ø 22	160	50	475	1030	1279	4	140	530	355	16	16	1418

BGAN = Base and coupling
Socle et accouplement
Base e giunto

* = Indicatives values according to the type of motor installed.
* = Valeurs indicatives en fonction de la marque du moteur utilisé.
* = Valori indicativi in funzione della marca di motore utilizzato.

COUPLINGS WITH STANDARDIZED ENCLOSED ELECTRIC MOTORS
 ACCOUPLEMENTS AVEC MOTEURS ÉLECTRIQUES FERMÉS NORMALISÉS
 ACCOPPIAMENTI CON MOTORI ELETTRICI CHIUSI NORMALIZZATI

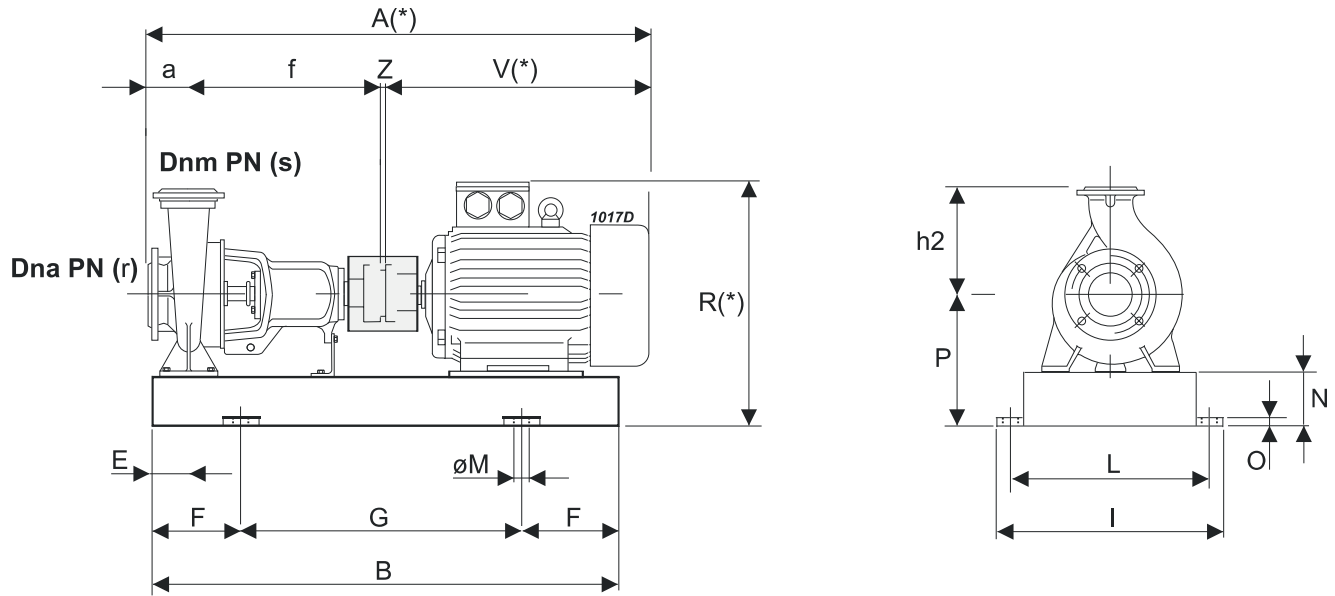

(*)Valori indicativi in funzione della marca di motore utilizzato
 Indicative values according to the type of motor installed

1017D

Pump Pompe Pompa		Motor Moteur Motore		BGAN	A*	B	E	F	G	I	L	M	N	O	P	R*	V*	Z	a	f	h2	r	s	Weight Poids Peso	
Type Type Tipo	DNa [mm]	DNm [mm]	[kW] kW	Size Taille Grand.	Type Type Tipo	[mm]																			
NC32-125	50	32	1,1	90S	1002/CA	799	710	70	100	510	340	290	ø 16	65	38	177	315	355	4	80	360	140	16	16	64
NC32-125	50	32	1,5	90L	1003/CA	829	735	70	100	535	340	290	ø 16	65	38	177	315	385	4	80	360	140	16	16	64
NC32-160	50	32	0,75	80M	1040/CA	739	659	60	100	459	390	340	ø 20	80	38	212	337	295	4	80	360	160	16	16	60
NC32-160	50	32	1,1	90S	1041/CA	799	710	60	100	510	390	340	ø 20	80	38	212	350	355	4	80	360	160	16	16	68
NC32-200	50	32	0,75	80M	1042/CA	739	689	60	100	489	390	340	ø 20	80	38	240	365	295	4	80	360	180	16	16	67
NC32-200	50	32	1,1	90S	1043/CA	799	710	60	100	510	390	340	ø 20	80	38	240	378	355	4	80	360	180	16	16	73
NC32-200	50	32	1,5	90L	1044/CA	829	700	60	100	500	370	320	ø 20	80	38	240	378	385	4	80	360	180	16	16	73
NC32-250	50	32	2,2	100L	1050/CA	869	774	72,5	150	474	470	420	ø 20	80	38	260	410	405	4	100	360	225	16	16	99
NC32-250	50	32	3	100L	1050/CA	869	774	72,5	150	474	470	420	ø 20	80	38	260	410	405	4	100	360	225	16	16	99
NC32-250	50	32	4	112M	1051/CA	904	787	82,5	150	487	470	420	ø 16	80	38	260	432	440	4	100	360	225	16	16	108
NC40-125	65	40	1,1	90S	1010/CA	799	710	70	100	510	360	310	ø 16	65	38	177	315	355	4	80	360	140	16	16	66
NC40-160	65	40	0,75	80M	1040/CA	739	659	60	100	459	390	340	ø 20	80	38	212	337	295	4	80	360	160	16	16	60
NC40-160	65	40	1,1	90S	1041/CA	799	710	60	100	510	390	340	ø 20	80	38	212	350	355	4	80	360	160	16	16	68
NC40-200	65	40	0,75	80M	1047/CA	759	689	60	100	489	415	365	ø 20	80	38	240	365	295	4	100	360	180	16	16	73
NC40-200	65	40	1,1	90S	1048/CA	819	675	60	100	475	415	365	ø 20	80	38	240	378	355	4	100	360	180	16	16	79
NC40-200	65	40	1,5	90L	1049/CA	849	700	60	100	500	415	365	ø 20	80	38	240	378	385	4	100	360	180	16	16	79
NC40-250	65	40	2,2	100L	1050/CA	869	774	72,5	150	474	470	420	ø 20	80	38	260	410	405	4	100	360	225	16	16	99
NC40-250	65	40	3	100L	1050/CA	869	774	72,5	150	474	470	420	ø 20	80	38	260	410	405	4	100	360	225	16	16	99
NC40-250	65	40	4	112M	1051/CA	904	787	82,5	150	487	470	420	ø 16	80	38	260	432	440	4	100	360	225	16	16	108
NC40-315	65	40	4	112M	1053/DX	1039	897	82,5	150	697	495	445	ø 20	100	42	300	472	440	4	125	470	225	16	16	175
NC40-315	65	40	5,5	132S	1054/DX	1054	941	82,5	150	641	495	445	ø 20	100	42	300	492	455	4	125	470	225	16	16	205
NC40-315	65	40	7,5	132M	1055/DX	1089	980	82,5	150	680	495	445	ø 20	100	42	300	492	490	4	125	470	225	16	16	205
NC40-315	65	40	11	160M	1056/EX	1226	1060	82,5	150	760	495	445	ø 20	100	42	300	551	627	4	125	470	225	16	16	245
NC50-125	65	50	0,75	80M	1040/CA	759	659	60	100	459	390	340	ø 20	80	38	212	337	295	4	100	360	160	16	16	60
NC50-160	65	50	0,75	80M	1047/CA	759	689	60	100	489	415	365	ø 20	80	38	240	365	295	4	100	360	180	16	16	73
NC50-160	65	50	1,1	90S	1048/CA	819	675	60	100	475	415	365	ø 20	80	38	240	378	355	4	100	360	180	16	16	79
NC50-160	65	50	1,5	90L	1049/CA	849	700	60	100	500	415	365	ø 20	80	38	240	378	385	4	100	360	180	16	16	79
NC50-200	65	50	1,1	90S	1048/CA	819	675	60	100	475	415	365	ø 20	80	38	240	378	355	4	100	360	200	16	16	78
NC50-200	65	50	1,5	90L	1049/CA	849	700	60	100	500	415	365	ø 20	80	38	240	378	385	4	100	360	200	16	16	78
NC50-200	65	50	2,2	100L	1052/CA	869	762	60	100	562	415	365	ø 20	80	38	240	390	405	4	100	360	200	16	16	87
NC50-250	65	50	2,2	100L	1050/CA	869	774	72,5	150	474	470	420	ø 20	80	38	260	410	405	4	100	360	225	16	16	99
NC50-250	65	50	3	100L	1050/CA	869	774	72,5	150	474	470	420	ø 20	80	38	260	410	405	4	100	360	225	16	16	99
NC50-250	65	50	4	112M	1051/CA	904	787	82,5	150	487	470	420	ø 16	80	38	260	432	440	4	100	360	225	16	16	108
NC50-315	65	50	4	112M	1132/DX	1039	897	82,5	100	697	495	445	ø 20	100	42	325	497	440	4	125	470	280	16	16	175
NC50-315	65	50	5,5	132S	1133/DX	1054	941	82,5	150	641	495	445	ø 20	100	42	325	517	455	4	125	470	280	16	16	205

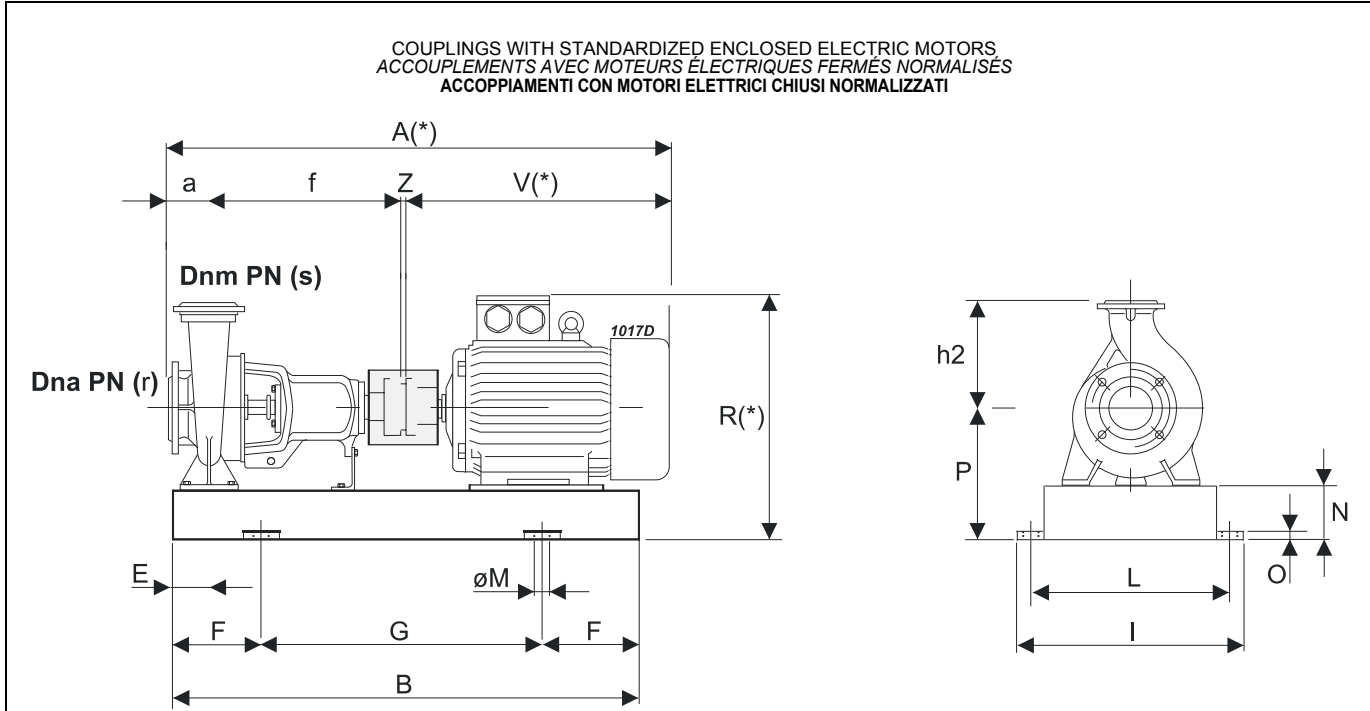

(*)Valori indicativi in funzione della marca di motore utilizzato
Indicative values according to the type of motor installed

Pump Pompe Pompa		Motor Moteur Motore		BGAN	A *	B	E	F	G	I	L	M	N	O	P	R *	V *	Z	a	f	h2	r	s	Weight Poids Peso	
Type Type Tipo	DNa [mm]	DNm [mm]	[kW] Size Taille Grand.	Type Type Tipo	[mm]																				
NC50-315	65	50	7,5	132M	1134/DX	1089	974	82,5	150	674	510	460	ø 20	100	42	325	517	490	4	125	470	280	16	16	205
NC50-315	65	50	11	160M	1135/EX	1226	1055	82,5	150	655	510	460	ø 20	100	42	325	576	627	4	125	470	280	16	16	245
NC65-125	80	65	0,75	80M	1152/CA	759	702	72,5	150	402	430	380	ø 16	80	38	240	365	295	4	100	360	180	16	16	70
NC65-125	80	65	1,1	90S	1153/CA	819	723	72,5	150	423	430	380	ø 16	80	38	240	378	355	4	100	360	180	16	16	76
NC65-160	80	65	0,75	80M	1057/CA	759	702	72,5	150	402	430	380	ø 20	80	38	240	365	295	4	100	360	200	16	16	75
NC65-160	80	65	1,1	90S	1153/CA	819	723	72,5	150	423	430	380	ø 16	80	38	240	378	355	4	100	360	200	16	16	81
NC65-160	80	65	1,5	90L	1059/CA	849	748	72,5	150	448	430	380	ø 20	80	38	240	378	385	4	100	360	200	16	16	81
NC65-160	80	65	2,2	100L	1060/CA	869	777	72,5	150	477	430	380	ø 20	80	38	240	390	405	4	100	360	200	16	16	90
NC65-200	80	65	1,5	90L	1061/CA	849	748	72,5	150	448	470	420	ø 20	80	38	260	398	385	4	100	360	225	16	16	84
NC65-200	80	65	2,2	100L	1050/CA	869	774	72,5	150	474	470	420	ø 20	80	38	260	410	405	4	100	360	225	16	16	99
NC65-200	80	65	3	100L	1050/CA	869	774	72,5	150	474	470	420	ø 20	80	38	260	410	405	4	100	360	225	16	16	99
NC65-200	80	65	4	112M	1051/CA	904	787	82,5	150	487	470	420	ø 16	80	38	260	432	440	4	100	360	225	16	16	108
NC65-250	80	65	3	100L	1062/DX	979	905	95	200	505	510	460	ø 20	100	42	300	450	405	4	100	470	250	16	16	132
NC65-250	80	65	4	112M	1063/DX	1014	914	95	200	514	510	460	ø 20	100	42	300	472	440	4	100	470	250	16	16	142
NC65-250	80	65	5,5	132S	1064/DX	1029	958	95	200	558	510	460	ø 20	100	42	300	492	455	4	100	470	250	16	16	174
NC65-250	80	65	7,5	132M	1065/DX	1064	986	95	200	586	510	460	ø 20	100	42	300	492	490	4	100	470	250	16	16	174
NC65-315	80	65	5,5	132S	1066/DX	1054	958	95	150	658	600	550	ø 20	100	42	325	517	455	4	125	470	280	16	16	210
NC65-315	80	65	7,5	132M	1067/DX	1089	997	95	150	697	550	500	ø 20	100	42	325	517	490	4	125	470	280	16	16	210
NC65-315	80	65	11	160M	1068/EX	1226	1068	95	150	768	550	500	ø 20	100	42	325	576	627	4	125	470	280	16	16	268
NC65-315	80	65	15	160L	1069/EX	1226	1111	95	150	811	550	500	ø 20	100	42	325	576	627	4	125	470	280	16	16	268
NC80-160	100	80	1,1	90S	1070/CA	844	723	72,5	150	423	470	420	ø 16	80	38	260	398	355	4	125	360	225	16	16	84
NC80-160	100	80	1,5	90L	1061/CA	874	748	72,5	150	448	470	420	ø 20	80	38	260	398	385	4	125	360	225	16	16	84
NC80-160	100	80	2,2	100L	1050/CA	894	774	72,5	150	474	470	420	ø 20	80	38	260	410	405	4	125	360	225	16	16	99
NC80-160	100	80	3	100L	1050/CA	894	774	72,5	150	474	470	420	ø 20	80	38	260	410	405	4	125	360	225	16	16	99
NC80-200	100	80	2,2	100L	1071/DX	1004	887	82,5	200	487	495	445	ø 16	80	38	260	410	405	4	125	470	250	16	16	120
NC80-200	100	80	3	100L	1071/DX	1004	887	82,5	200	487	495	445	ø 16	80	38	260	410	405	4	125	470	250	16	16	120
NC80-200	100	80	4	112M	1072/DX	1039	897	82,5	200	497	495	445	ø 16	80	38	260	432	440	4	125	470	250	16	16	125
NC80-200	100	80	5,5	132S	1073/DX	1054	925	82,5	150	625	490	440	ø 20	100	50	280	472	455	4	125	470	250	16	16	155
NC80-200	100	80	7,5	132M	1074/DX	1089	963	82,5	150	663	490	440	ø 20	100	50	280	472	490	4	125	470	250	16	16	155
NC80-250	100	80	5,5	132S	1075/DX	1054	958	95	200	558	550	500	ø 20	100	42	300	492	455	4	125	470	280	16	16	174
NC80-250	100	80	7,5	132M	1076/DX	1089	996	95	200	596	550	500	ø 20	100	42	300	492	490	4	125	470	280	16	16	174
NC80-250	100	80	11	160M	1077/EX	1226	1040	95	250	540	550	500	ø 20	100	42	300	551	627	4	125	470	280	16	16	228
NC80-250	100	80	15	160L	1078/EX	1226	1122	95	250	622	550	500	ø 20	100	42	300	551	627	4	125	470	280	16	16	228
NC80-315	100	80	7,5	132M	1079/DX	1089	997	95	250	497	550	500	ø 20	120	42	370	562	490	4	125	470	315	16	16	235
NC80-315	100	80	11	160M	1080/EX	1226	1077	95	250	577	550	500	ø 20	120	42	370	621	627	4	125	470	315	16	16	297

Selection - dimensions and weights for base mounted electric pumps
 Sélection - dimensions et poids des électropompes sur socle
 Selezione - dimensioni e pesi elettropompe su base

COUPLINGS WITH STANDARDIZED ENCLOSED ELECTRIC MOTORS
 ACCOUPLEMENTS AVEC MOTEURS ÉLECTRIQUES FERMÉS NORMALISÉS
 ACCOPIAMENTI CON MOTORI ELETTRICI CHIUSI NORMALIZZATI

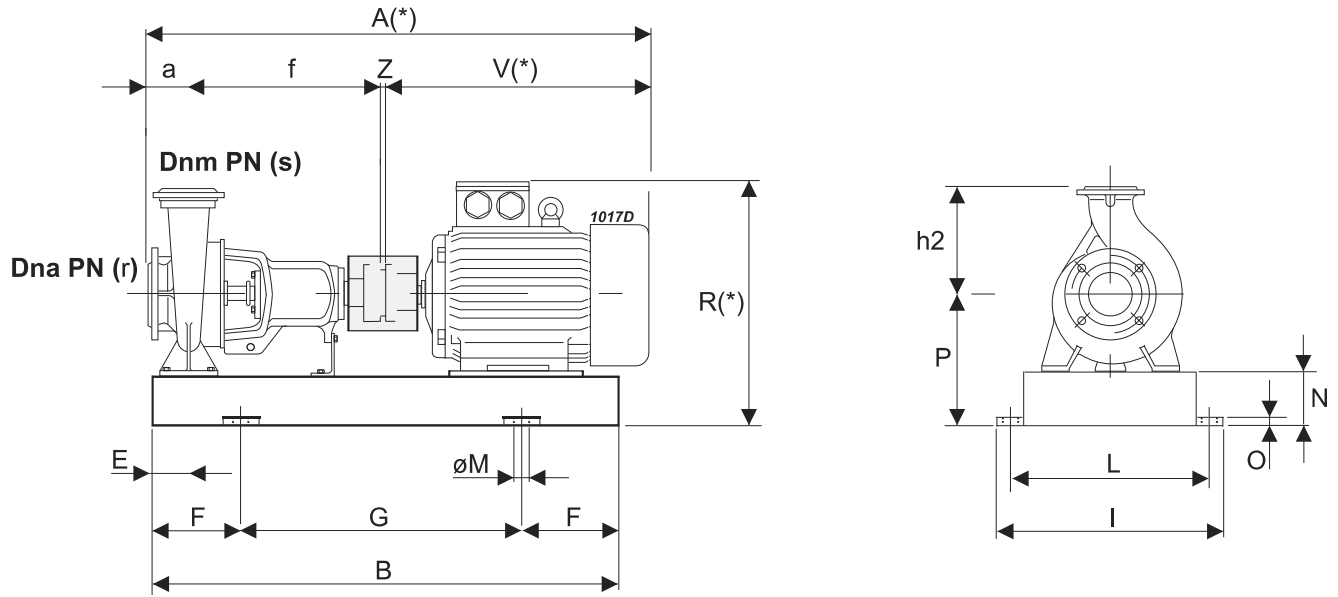

(*)Valori indicativi in funzione della marca di motore utilizzato
 Indicative values according to the type of motor installed

1017D

Pump Pompe Pompa			Motor Moteur Motore		BGAN	A*	B	E	F	G	I	L	M	N	O	P	R*	V*	Z	a	f	h2	r	s	Weight Poids Peso	
Type Type Tipo	DNa [mm]	DNm [mm]	[kW]	Size Taille Grand.	Type Type Tipo	[mm]																				
NC80-315	100	80	15	160L	1081/EX	1226	1121	95	250	621	550	500	ø 20	120	42	370	621	627	4	125	470	315	16	16	297	
NC80-315	100	80	18,5	180M	1082/FX	1264	1111	95	250	611	550	500	ø 20	120	42	370	640	665	4	125	470	315	16	16	343	
NC80-400	100	80	18,5	180M	1091/FY	1326	1195	95	250	695	590	540	ø 20	140	45	420	690	665	4	125	532	355	16	16	400	
NC80-400	100	80	22	180L	1092/FY	1366	1241	95	250	741	590	540	ø 20	140	45	420	690	705	4	125	532	355	16	16	400	
NC80-400	100	80	30	200L	1093/GY	1419	1250	95	250	750	640	590	ø 20	140	45	420	720	758	4	125	532	355	16	16	470	
NC100-160	125	100	3	100L	1062/DX	1004	905	95	200	505	510	460	ø 20	100	42	300	450	405	4	125	470	250	16	16	132	
NC100-160	125	100	4	112M	1063/DX	1039	914	95	200	514	510	460	ø 20	100	42	300	472	440	4	125	470	250	16	16	142	
NC100-160	125	100	5,5	132S	1064/DX	1054	958	95	200	558	510	460	ø 20	100	42	300	492	455	4	125	470	250	16	16	174	
NC100-160	125	100	7,5	132M	1065/DX	1089	986	95	200	586	510	460	ø 20	100	42	300	492	490	4	125	470	250	16	16	174	
NC100-200	125	100	3	100L	1062/DX	1004	905	95	200	505	510	460	ø 20	100	42	300	450	405	4	125	470	280	16	16	132	
NC100-200	125	100	4	112M	1063/DX	1039	914	95	200	514	510	460	ø 20	100	42	300	472	440	4	125	470	280	16	16	142	
NC100-200	125	100	5,5	132S	1064/DX	1054	958	95	200	558	510	460	ø 20	100	42	300	492	455	4	125	470	280	16	16	174	
NC100-200	125	100	7,5	132M	1065/DX	1089	986	95	200	586	510	460	ø 20	100	42	300	492	490	4	125	470	280	16	16	174	
NC100-250	125	100	5,5	132S	1066/DX	1069	958	95	150	658	600	550	ø 20	100	42	325	517	455	4	140	470	280	16	16	210	
NC100-250	125	100	7,5	132M	1067/DX	1104	997	95	150	697	550	500	ø 20	100	42	325	517	490	4	140	470	280	16	16	210	
NC100-250	125	100	11	160M	1068/EX	1241	1068	95	150	768	550	500	ø 20	100	42	325	576	627	4	140	470	280	16	16	268	
NC100-250	125	100	15	160L	1069/EX	1241	1111	95	150	811	550	500	ø 20	100	42	325	576	627	4	140	470	280	16	16	268	
NC100-315	125	100	11	160M	1080/EX	1241	1077	95	250	577	550	500	ø 20	120	42	370	621	627	4	140	470	315	16	16	297	
NC100-315	125	100	15	160L	1081/EX	1241	1121	95	250	621	550	500	ø 20	120	42	370	621	627	4	140	470	315	16	16	297	
NC100-315	125	100	18,5	180M	1082/FX	1279	1111	95	250	611	550	500	ø 20	120	42	370	640	665	4	140	470	315	16	16	343	
NC100-315	125	100	22	180L	1083/FX	1319	1149	95	250	649	550	500	ø 20	120	42	370	640	705	4	140	470	315	16	16	343	
NC100-400	125	100	22	180L	1084/FY	1379	1224	110	250	724	650	600	ø 20	140	45	420	690	705	4	140	530	355	16	16	465	
NC100-400	125	100	30	200L	1085/GY	1432	1262	110	250	762	650	600	ø 20	140	45	420	720	758	4	140	530	355	16	16	535	
NC100-400	125	100	37	225S	1086/GY	1467	1289	110	300	689	640	590	ø 20	140	42	420	750	793	4	140	530	355	16	16	624	
NC100-400	125	100	45	225M	1087/HY	1492	1314	110	300	714	640	590	ø 20	140	42	420	750	818	4	140	530	355	16	16	624	
NC100-400	125	100	55	250M	1088/HY	1554	1409	110	300	809	650	600	ø 20	140	45	420	795	880	4	140	530	355	16	16	762	
NC125-200	150	125	7,5	132M	1079/DX	1104	997	95	250	497	550	500	ø 20	120	42	370	562	490	4	140	470	315	16	16	235	
NC125-200	150	125	11	160M	1080/EX	1241	1077	95	250	577	550	500	ø 20	120	42	370	621	627	4	140	470	315	16	16	297	
NC125-200	150	125	15	160L	1081/EX	1241	1121	95	250	621	550	500	ø 20	120	42	370	621	627	4	140	470	315	16	16	297	
NC125-200	150	125	18,5	180M	1082/FX	1279	1111	95	250	611	550	500	ø 20	120	42	370	640	665	4	140	470	315	16	16	343	
NC125-200	150	125	22	180L	1083/FX	1319	1149	95	250	649	550	500	ø 20	120	42	370	640	705	4	140	470	315	16	16	343	
NC125-250	150	125	11	160M	1080/EX	1241	1077	95	250	577	550	500	ø 20	120	42	370	621	627	4	140	470	355	16	16	297	
NC125-250	150	125	15	160L	1081/EX	1241	1121	95	250	621	550	500	ø 20	120	42	370	621	627	4	140	470	355	16	16	297	
NC125-250	150	125	18,5	180M	1082/FX	1279	1111	95	250	611	550	500	ø 20	120	42	370	640	665	4	140	470	355	16	16	343	
NC125-250	150	125	22	180L	1083/FX	1319	1149	95	250	649	550	500	ø 20	120	42	370	640	705	4	140	470	355	16	16	340	
NC125-315	150	125	15	160L	1090/EY	1301	1202	110	250	702	650	600	ø 20	140	45	420	671	627	4	140	530	355	16	16	355	

Selection - dimensions and weights for base mounted electric pumps
Sélection - dimensions et poids des électropompes sur socle
Selezione - dimensioni e pesi elettropompe su base

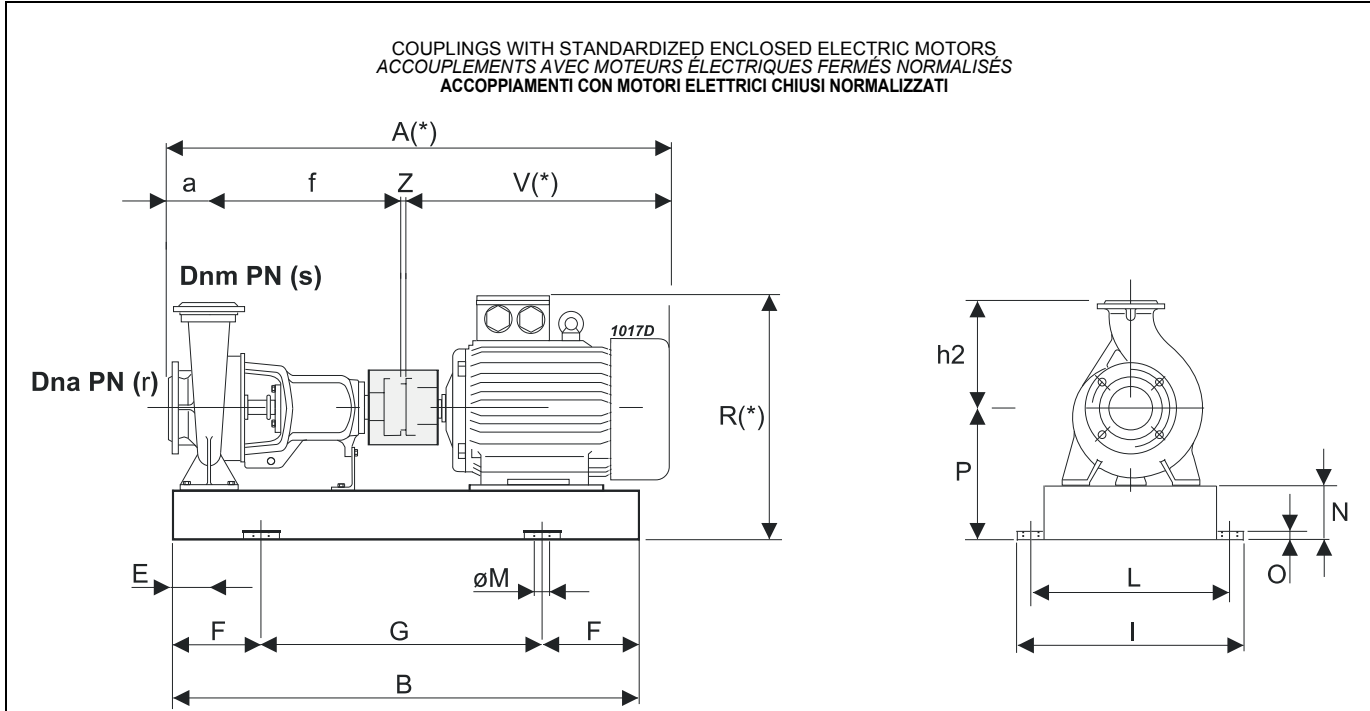

(*)Valori indicativi in funzione della marca di motore utilizzato
Indicative values according to the type of motor installed

Pump Pompe Pompa		Motor Moteur Motore		BGAN	A *	B	E	F	G	I	L	M	N	O	P	R *	V *	Z	a	f	h2	r	s	Weight Poids Peso	
Type Type Tipo	DNa [mm]	DNm [mm]	[kW] Size Taille Grand.	Type Type Tipo	[mm]																				
NC125-315	150	125	18,5	180M	1154/FY	1339	1213	110	250	713	650	600	ø 20	140	45	420	690	665	4	140	530	355	16	16	405
NC125-315	150	125	22	180L	1084/FY	1379	1224	110	250	724	650	600	ø 20	140	45	420	690	705	4	140	530	355	16	16	465
NC125-315	150	125	30	200L	1085/GY	1432	1262	110	250	762	650	600	ø 20	140	45	420	720	758	4	140	530	355	16	16	535
NC125-315	150	125	37	225S	1086/GY	1467	1289	110	300	689	640	590	ø 20	140	42	420	750	793	4	140	530	355	16	16	624
NC125-315	150	125	45	225M	1087/HY	1492	1314	110	300	714	640	590	ø 20	140	42	420	750	818	4	140	530	355	16	16	624
NC125-400	150	125	45	225M	1096/HY	1492	1314	110	300	714	650	600	ø 22	160	50	475	805	818	4	140	530	400	16	16	640
NC125-400	150	125	55	250M	1097/HY	1554	1409	110	300	809	650	600	ø 22	160	45	475	850	880	4	140	530	400	16	16	762
NC125-400	150	125	75	280S	1098/IY	1694	1412	110	300	812	700	650	ø 22	160	50	475	865	1020	4	140	530	400	16	16	925
NCH125-400	150	125	22	180L	2046/FY3	1379	1219	115	200	819	670	620	ø 22	160	50	475	745	705	4	140	530	400	16	16	487
NCH125-400	150	125	30	200L	2048/GY3	1432	1257	115	200	857	670	620	ø 22	160	50	475	775	758	4	140	530	400	16	16	550
NCH125-400	150	125	37	225S	2050/GY3	1467	1294	115	200	894	670	620	ø 22	160	50	475	805	793	4	140	530	400	16	16	638
NCH125-400	150	125	45	225M	2049/HY4	1492	1319	115	200	919	670	620	ø 22	160	50	475	805	818	4	140	530	400	16	16	682
NCH125-400	150	125	55	250M	2051/HY4	1554	1409	115	250	909	670	620	ø 22	160	50	475	850	880	4	140	530	400	16	16	779
NCH125-400	150	125	75	280S	2052/IY4	1694	1468	115	300	868	700	650	ø 22	160	50	475	865	1020	4	140	530	400	16	16	799
NCH125-400	150	125	90	280M	2052/IY4	1744	1468	115	300	868	700	650	ø 22	160	50	475	865	1070	4	140	530	400	16	16	957
NCH125-500	150	125	90	280M	2027/IY4	1904	1893	175	300	1293	960	910	ø 22	200	50	600	990	1070	4	160	670	450	16	16	1332
NCH125-500	150	125	110	315S	2028/LY4	2019	1936	175	350	1236	960	910	ø 22	200	50	600	1155	1185	4	160	670	450	16	16	1544
NCH125-500	150	125	132	315M	2029/LY4	2157	2116	175	350	1416	960	910	ø 22	200	50	600	1155	1323	4	160	670	450	16	16	1658
NCH125-500	150	125	160	315L	2029/MY5	2157	2116	175	350	1416	960	910	ø 22	200	50	600	1155	1323	4	160	670	450	16	16	1808
NCH125-500	150	125	200	315L	2029/MY5	2157	2116	175	350	1416	960	910	ø 22	200	50	600	1155	1323	4	160	670	450	16	16	1863
NCH125-500	150	125	250	355M	2026/NY5	2390	2163	175	350	1463	960	910	ø 22	200	50	600	1201	1556	4	160	670	450	16	16	2285
NC150-200	200	150	11	160M	1129/EX	1286	1122	110	250	622	700	650	ø 20	140	45	420	671	627	4	160	495	400	16	16	435
NC150-200	200	150	15	160L	1130/EX	1286	1151	110	250	651	700	650	ø 20	140	45	420	671	627	4	160	495	400	16	16	450
NC150-200	200	150	18,5	180M	1131/FY	1324	1181	110	250	681	700	650	ø 20	140	45	420	690	665	4	160	495	400	16	16	490
NC150-200	200	150	22	180L	1099/FX	1364	1215	110	250	715	700	650	ø 20	140	45	420	690	705	4	160	495	400	16	16	495
NC150-250	200	150	18,5	180M	1136/FY	1359	1201	110	250	701	600	550	ø 20	120	42	370	640	665	4	160	530	355	16	16	400
NC150-250	200	150	22	180L	1137/FY	1399	1244	110	250	744	600	550	ø 20	120	42	370	640	705	4	160	530	355	16	16	400
NC150-250	200	150	30	200L	1151/GY	1452	1252	110	250	752	600	550	ø 20	140	45	390	690	758	4	160	530	355	16	16	470
NC150-315	200	150	22	180L	1138/FY	1399	1250	110	250	713	700	650	ø 20	140	45	420	690	705	4	160	530	400	16	16	495
NC150-315	200	150	30	200L	1100/GX	1452	1262	110	250	762	700	650	ø 20	140	45	420	720	758	4	160	530	400	16	16	556
NC150-315	200	150	37	225S	1101/GX	1487	1290	110	300	690	700	650	ø 22	140	45	420	750	793	4	160	530	400	16	16	650
NC150-315	200	150	45	225M	1102/HY	1512	1345	110	300	745	700	650	ø 22	140	45	420	750	818	4	160	530	400	16	16	650
NC150-315	200	150	55	250M	1103/HY	1574	1361	110	300	761	700	650	ø 22	140	45	420	795	880	4	160	530	400	16	16	772
NC150-400	200	150	45	225M	1139/HY	1512	1346	110	300	746	700	650	ø 22	160	50	475	805	818	4	160	530	450	16	16	665
NC150-400	200	150	55	250M	1140/HY	1574	1409	110	300	809	700	650	ø 22	160	50	475	850	880	4	160	530	450	16	16	787

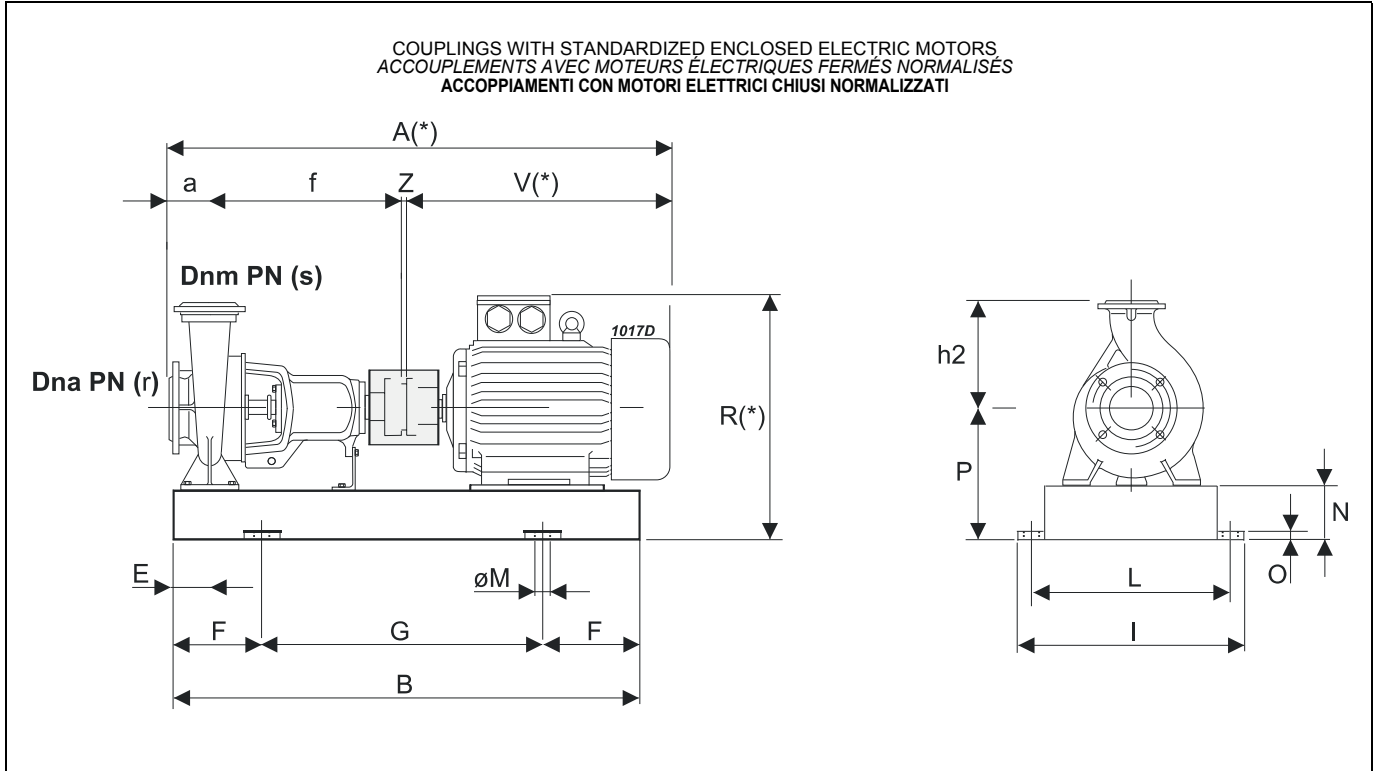

(*)Valori indicativi in funzione della marca di motore utilizzato
 Indicative values according to the type of motor installed

Pump Pompe Pompa		Motor Moteur Motore		BGAN	A *	B	E	F	G	I	L	M	N	O	P	R *	V *	Z	a	f	h2	r	s	Weight Poids Peso	
Type Type Tipo	DNa	DNm	Size Taille Grand.	Type Type Tipo	[mm]																				
	[mm]	[mm]	[kW]																						
NC150-400	200	150	75	280S	1104/IY	1714	1412	110	300	812	700	650	ø 22	160	50	475	865	1020	4	160	530	450	16	16	950
NC150-400	200	150	90	280M	1105/IY	1764	1503	110	300	903	700	650	ø 22	160	50	475	865	1070	4	160	530	450	16	16	1040
NC150-400	200	150	110	315S	1106/LY	1879	1578	110	300	978	780	730	ø 22	160	50	475	1030	1185	4	160	530	450	16	16	1180
NCH150-500	200	150	45	225M	2018/GY2	1652	1529	160	250	1029	720	670	ø 22	200	50	600	930	818	4	160	670	500	16	16	863
NCH150-500	200	150	55	250M	2019/HY2	1714	1586	160	250	1086	720	670	ø 22	200	50	600	975	880	4	160	670	500	16	16	925
NCH150-500	200	150	75	280S	2020/IY2	1854	1627	160	250	1127	720	670	ø 22	200	50	600	990	1020	4	160	670	500	16	16	1056
NCH150-500	200	150	90	280M	2021/IY2	1904	1678	160	300	1078	720	670	ø 22	200	50	600	990	1070	4	160	670	500	16	16	991
NCH150-500	200	150	110	315S	2022/LY2	2019	1751	160	300	1151	800	750	ø 22	200	50	600	1155	1185	4	160	670	500	16	16	1480
NCH150-500	200	150	132	315M	2023/MY2	2157	1802	160	300	1202	800	750	ø 22	200	50	600	1155	1323	4	160	670	500	16	16	1561
NCH150-500	200	150	160	315L	2023/MY2	2157	1802	160	300	1202	800	750	ø 22	200	50	600	1155	1323	4	160	670	500	16	16	1629
NCH150-500	200	150	200	315L	2023/MY2	2157	1802	160	300	1202	800	750	ø 22	200	50	600	1155	1323	4	160	670	500	16	16	1740
NC200-250	250	200	30	200L	1108/GY	1495	1308	110	300	708	700	650	ø 22	160	50	475	775	758	4	180	553	450	16	16	567
NC200-250	250	200	37	225S	1109/GY	1530	1344	110	300	744	700	650	ø 22	160	50	475	805	793	4	180	553	450	16	16	613
NC200-250	250	200	45	225M	1141/HY	1555	1369	110	300	769	700	650	ø 22	160	50	475	805	818	4	180	553	450	16	16	667
NC200-250	250	200	55	250M	1110/HY	1617	1432	110	300	832	700	650	ø 22	160	50	475	850	880	4	180	553	450	16	16	726
NC200-315	250	200	30	200L	1111/GY2	1612	1422	120	250	922	750	700	ø 22	160	50	475	775	758	4	180	670	480	16	16	662
NC200-315	250	200	37	225S	1112/GY2	1647	1464	120	300	864	750	700	ø 22	160	45	475	805	793	4	180	670	480	16	16	740
NC200-315	250	200	45	225M	1113/HY2	1672	1464	120	300	864	750	700	ø 22	160	45	475	805	818	4	180	670	480	16	16	740
NC200-315	250	200	55	250M	1114/HY2	1734	1531	120	300	931	750	700	ø 20	160	45	475	850	880	4	180	670	480	16	16	842
NC200-315	250	200	75	280S	1115/IY2	1874	1562	120	300	962	750	700	ø 22	160	50	475	865	1020	4	180	670	480	16	16	1000
NC200-400	250	200	75	280S	1116/IY2	1874	1568	120	300	968	750	700	ø 22	160	50	495	885	1020	4	180	670	480	16	16	1003
NC200-400	250	200	90	280M	1117/IY2	1924	1613	120	300	1013	750	700	ø 22	160	50	495	885	1070	4	180	670	480	16	16	1092
NC200-400	250	200	110	315S	1118/LY2	2039	1656	120	300	1056	750	700	ø 22	160	50	495	1050	1185	4	180	670	480	16	16	1240
NC200-400	250	200	132	315M	1120/LY2	2177	1707	120	300	1107	750	700	ø 22	160	50	495	1050	1323	4	180	670	480	16	16	1340
NCH200-500	250	200	90	280M	2027/IY4	2184	1893	175	300	1293	960	910	ø 22	200	50	600	990	1070	4	225	885	580	16	16	1332
NCH200-500	250	200	110	315S	2028/LY4	2299	1936	175	350	1236	960	910	ø 22	200	50	600	1155	1185	4	225	885	580	16	16	1544
NCH200-500	250	200	132	315M	2029/LY4	2437	2116	175	350	1416	960	910	ø 22	200	50	600	1155	1323	4	225	885	580	16	16	1658
NCH200-500	250	200	160	315L	2029/MY5	2437	2116	175	350	1416	960	910	ø 22	200	50	600	1155	1323	4	225	885	580	16	16	1808
NCH200-500	250	200	200	315L	2029/MY5	2437	2116	175	350	1416	960	910	ø 22	200	50	600	1155	1556	4	225	885	580	16	16	1863
NCH200-500	250	200	250	355M	2026/NY5	2670	2163	175	350	1463	960	910	ø 22	200	50	600	1201	1556	4	225	885	580	16	16	2285
NCH200-500	250	200	315	355L	2026/PY5	2670	2163	175	350	1463	960	910	ø 22	200	50	600	1201	1556	4	225	885	580	16	16	2475
NC250-315	300	250	30	200L	1142/GY2	1673	1468	135	250	968	810	760	ø 22	180	50	535	835	758	4	220	691	520	16	16	622
NC250-315	300	250	37	225S	1143/GY2	1708	1507	135	300	907	810	760	ø 22	180	50	535	865	793	4	220	691	520	16	16	740
NC250-315	300	250	45	225M	1144/HY2	1733	1510	135	300	910	810	760	ø 22	180	50	535	865	818	4	220	691	520	16	16	740
NC250-315	300	250	55	250M	1145/HY2	1795	1595	135	300	995	810	760	ø 22	180	50	535	910	880	4	220	691	520	16	16	842
NC250-315	300	250	75	280S	1146/IY2	1935	1648	135	300	1048	810	760	ø 22	180	50	535	925	1020	4	220	691	520	16	16	1000

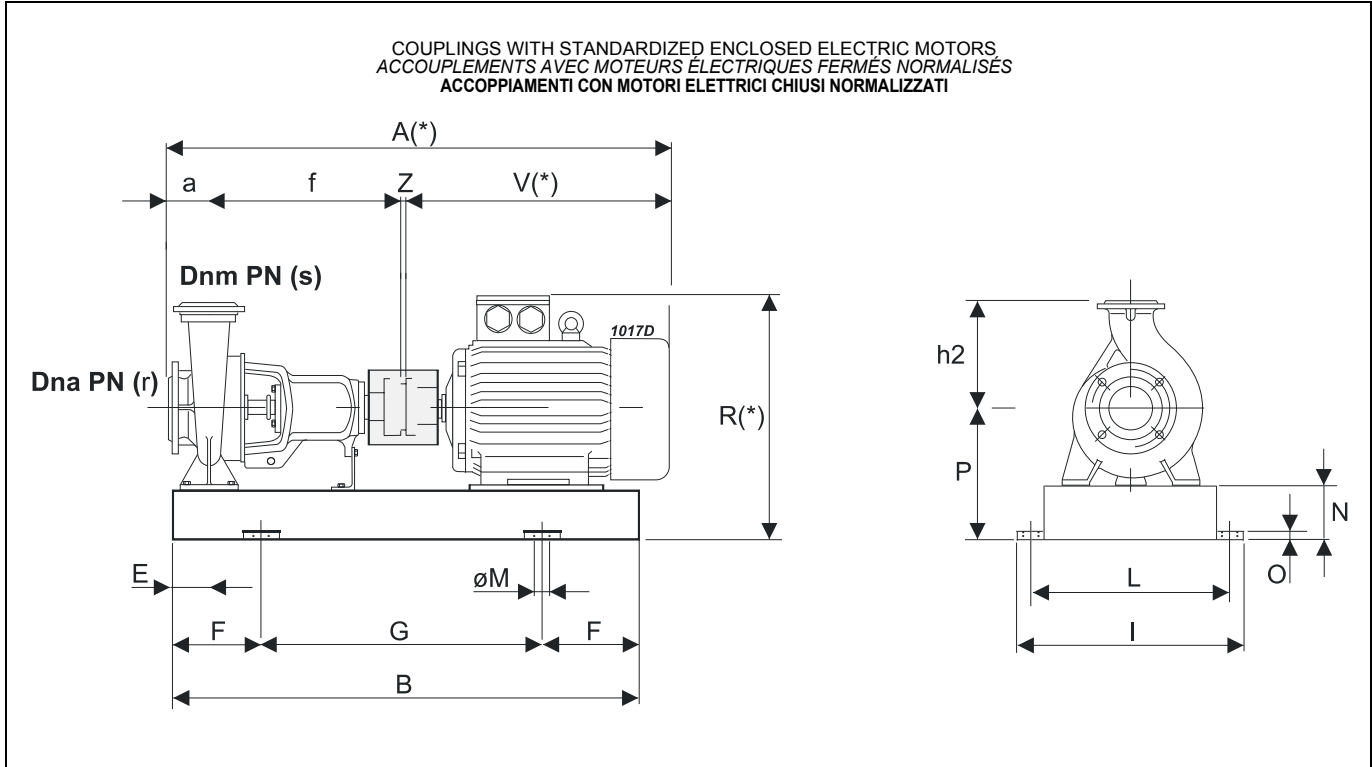

(*)Valori indicativi in funzione della marca di motore utilizzato
Indicative values according to the type of motor installed

Pump Pompe Pompa		Motor Moteur Motore		BGAN	A *	B	E	F	G	I	L	M	N	O	P	R *	V *	Z	a	f	h2	r	s	Weight Poids Peso	
Type Type Tipo	DNa [mm]	DNm [mm]	[kW] kW	Size Taille Grand.	Type Type Tipo	[mm]																			
NC250-400	300	250	75	280S	1147/IY2	1926	1640	135	300	1040	810	760	ø 22	200	50	600	990	1020	4	220	682	560	16	16	1003
NC250-400	300	250	90	280M	1148/IY2	1976	1690	135	300	1090	810	760	ø 22	200	50	600	990	1070	4	220	682	560	16	16	1092
NC250-400	300	250	110	315S	1149/LY2	2091	1733	135	300	1133	810	760	ø 22	200	50	600	1155	1185	4	220	682	560	16	16	1240
NC250-400	300	250	132	315M	1119/LY2	2229	1795	135	300	1195	810	760	ø 22	200	50	600	1155	1323	4	220	682	560	16	16	1340
NC250-400	300	250	160	315L	1119/LY2	2229	1795	135	300	1195	810	760	ø 22	200	50	600	1155	1323	4	220	682	560	16	16	1340
NCH250-250	300	250	75	280S	2054/IY4	2134	1802	145	300	1202	810	760	ø 22	180	50	535	925	1020	4	225	885	560	16	16	997
NCHF250-500	300	250	160	315L	2024/MY5	2437	2038	175	300	1438	960	910	ø 22	200	50	650	1205	1323	4	225	885	630	16	16	1865
NCHF250-500	300	250	200	315L	2024/MY5	2437	2038	175	300	1438	960	910	ø 22	200	50	650	1205	1323	4	225	885	630	16	16	1920
NCHF250-500	300	250	250	355M	2040/NY5	2670	2168	175	350	1468	960	910	ø 22	200	50	650	1251	1556	4	225	885	630	16	16	2395
NCHF250-500	300	250	315	355L	2040/PY5	2670	2168	175	350	1468	960	910	ø 22	200	50	650	1251	1556	4	225	885	630	16	16	2585
NCHF250-500	300	250	355	355L	2040/PY5	2670	2168	175	350	1468	960	910	ø 22	200	50	650	1251	1556	4	225	885	630	16	16	2600

BGAN = Base and coupling
Socle et accouplement
Base e giunto

* = Indicatives values according to the type of motor installed.
* = Valeurs indicatives en fonction de la marque du moteur utilisé.
* = Valori indicativi in funzione della marca di motore utilizzato.

Selection - dimensions and weights for base mounted electric pumps
 Sélection - dimensions et poids des électropompes sur socle
 Selezione - dimensioni e pesi elettropompe su base

COUPLINGS WITH STANDARDIZED ENCLOSED ELECTRIC MOTORS
 ACCOUPLEMENTS AVEC MOTEURS ÉLECTRIQUES FERMÉS NORMALISÉS
 ACCOPPIAMENTI CON MOTORI ELETTRICI CHIUSI NORMALIZZATI

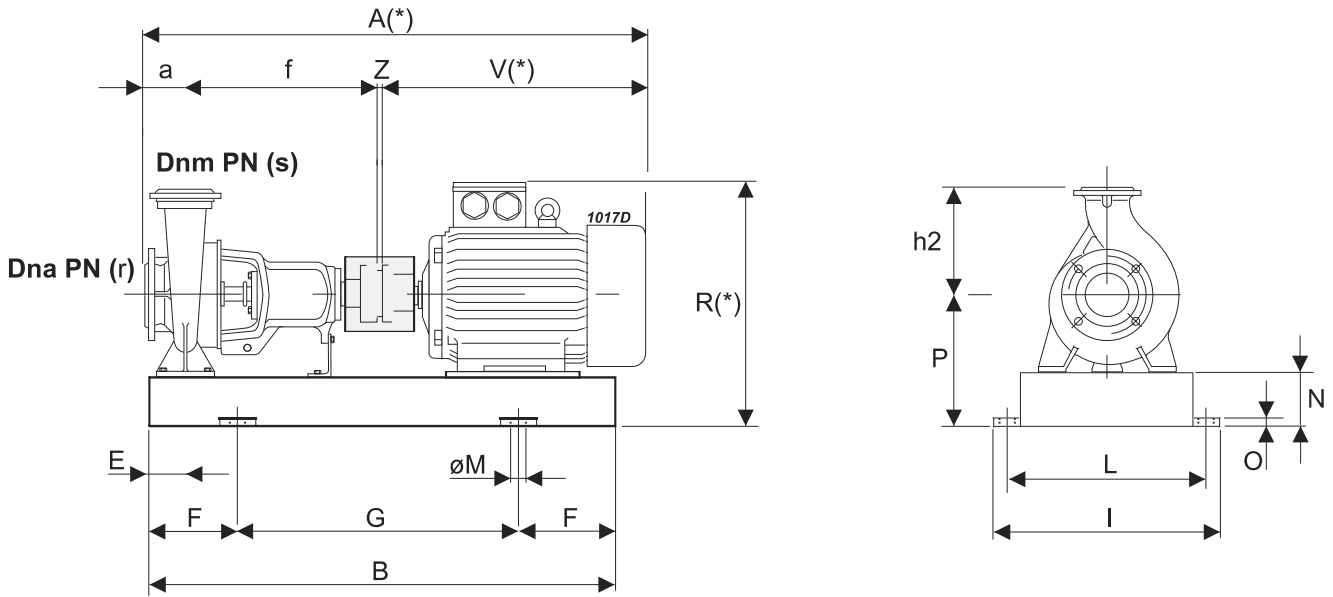

(*Valori indicativi in funzione della marca di motore utilizzato
 Indicative values according to the type of motor installed

Pump Pompe Pompa		Motor Moteur Motore		BGAN	A*	B	E	F	G	I	L	M	N	O	P	R*	V*	Z	a	f	h2	r	s	Weight Poids Peso	
Type Type Tipo	DNa [mm]	DNm [mm]	[kW] kW	Size Taille Grand.	Type Type Tipo	[mm]																			
NCH125-400	150	125	11	160L	2045/EY3	1301	1137	115	200	737	670	620	ø 22	160	50	475	726	627	4	140	530	400	16	16	428
NCH125-400	150	125	15	180L	2046/FY3	1379	1219	115	200	819	670	620	ø 22	160	50	475	745	705	4	140	530	400	16	16	482
NCH125-400	150	125	18,5	200L	2048/FY3	1432	1257	115	200	857	670	620	ø 22	160	50	475	775	758	4	140	530	400	16	16	524
NCH125-400	150	125	22	200L	2048/GY3	1432	1257	115	200	857	670	620	ø 22	160	50	475	775	758	4	140	530	400	16	16	540
NCH125-400	150	125	30	225M	2049/HY4	1492	1319	115	200	919	670	620	ø 22	160	50	475	805	818	4	140	530	400	16	16	659
NCH125-500	150	125	15	180L	2038/FY3	1539	1389	125	300	789	750	700	ø 22	180	50	535	805	705	4	160	670	450	16	16	677
NCH125-500	150	125	18,5	200L	2039/FY3	1592	1417	125	250	917	750	700	ø 22	180	50	535	835	758	4	160	670	450	16	16	717
NCH125-500	150	125	22	200L	2039/GY3	1592	1417	125	250	917	750	700	ø 22	180	50	535	835	758	4	160	670	450	16	16	733
NCH125-500	150	125	30	225M	2034/HY4	1652	1479	125	250	979	750	700	ø 22	180	50	535	865	818	4	160	670	450	16	16	814
NCH125-500	150	125	37	250M	2033/HY4	1714	1526	125	250	1026	750	700	ø 22	180	50	535	910	880	4	160	670	450	16	16	884
NCH125-500	150	125	45	280S	2035/IY4	1854	1567	125	250	1067	750	700	ø 22	180	50	535	925	1020	4	160	670	450	16	16	1067
NCH200-500	250	200	30	225M	2031/HY4	1932	1734	175	300	1134	960	910	ø 22	200	50	600	930	818	4	225	885	580	16	16	946
NCH200-500	250	200	37	250M	2032/HY4	1994	1791	175	300	1191	960	910	ø 22	200	50	600	975	880	4	225	885	580	16	16	1004
NCH200-500	250	200	45	280S	2030/IY4	2134	1842	175	300	1242	960	910	ø 22	200	50	600	990	1020	4	225	885	580	16	16	1241
NCH200-500	250	200	55	280M	2027/IY4	2184	1893	175	300	1293	960	910	ø 22	200	50	600	990	1070	4	225	885	580	16	16	1324
NCH200-500	250	200	75	315S	2028/LY4	2299	1936	175	350	1236	960	910	ø 22	200	50	600	1155	1185	4	225	885	580	16	16	1529
NCH200-500	250	200	90	315M	2029/LY4	2437	2116	175	350	1416	960	910	ø 22	200	50	600	1155	1323	4	225	885	580	16	16	1658
NCH250-250	300	250	18,5	200L	2055/HY4	1872	1652	145	300	1052	810	760	ø 22	180	50	535	835	758	4	225	885	560	16	16	721
NCH250-250	300	250	22	200L	2055/HY4	1872	1652	145	300	1052	810	760	ø 22	180	50	535	835	758	4	225	885	560	16	16	737
NCHF250-500	300	250	45	280S	2042/IY4	2134	1832	175	300	1232	960	910	ø 22	200	50	650	1040	1020	4	225	885	630	16	16	1241
NCHF250-500	300	250	55	280M	2043/IY4	2184	1883	175	300	1283	960	910	ø 22	200	50	650	1040	1070	4	225	885	630	16	16	1325
NCHF250-500	300	250	75	315S	2044/LY4	2299	1936	175	350	1236	960	910	ø 22	200	50	650	1205	1185	4	225	885	630	16	16	1602
NCHF250-500	300	250	90	315M	2041/LY4	2437	2038	175	300	1438	960	910	ø 22	200	50	650	1205	1323	4	225	885	630	16	16	1715
NCHF250-500	300	250	110	315L	2024/MY5	2437	2038	175	300	1438	960	910	ø 22	200	50	650	1205	1323	4	225	885	630	16	16	1785

BGAN = Base and coupling
 Socle et accouplement
 Base e giunto

* = Indicatives values according to the type of motor installed.
 * = Valeurs indicatives en fonction de la marque du moteur utilisé.
 * = Valori indicativi in funzione della marca di motore utilizzato.

Flanges (UNI EN 1092-2)
 Brides (UNI EN 1092-2)
 Flange (UNI EN 1092-2)

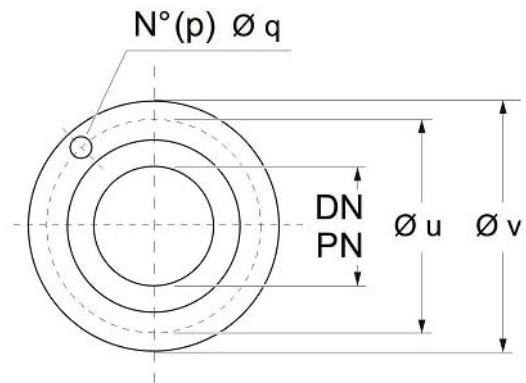

Port \varnothing \varnothing Orifice \varnothing Bocca		Holes Trous Fori		$\varnothing u$	$\varnothing v$
DN [mm]	PN [bar]	p No	q \varnothing [mm]	[mm]	
32	16	4	18	100	140
40	16	4	18	110	150
50	16	4	18	125	165
50	25	4	18	125	165
65	16	4	18	145	185
80	16	8	18	160	200
100	16	8	18	180	220
125	16	8	18	210	250
150	16	8	22	240	285
200	16	12	22	295	340
250	16	12	26	355	405
300	16	12	26	410	460

caprari

The dimensions have an indicative value. Executive drawing will be supplied on request upon order.
CAPRARI S.p.A. reserves the right to make changes to improve its products at any time and without any notice

*Les dimensions sont fournies à titre indicatif. Le plan bon pour exécution sera fourni sur demande au moment de la commande.
CAPRARI S.p.A. se réserve la faculté d'apporter des modifications visant à améliorer ses propres produits à tout moment et sans aucun préavis.*

**Le dimensioni hanno valore indicativo. Il disegno esecutivo sarà fornito su richiesta in fase d'ordine.
CAPRARI S.p.A. si riserva facoltà di apportare modifiche atte a migliorare i propri prodotti in qualsiasi momento e senza preavviso alcuno.**